

**MCT6 MCT62
MCT61 MCT66**

PACKAGE DIMENSIONS

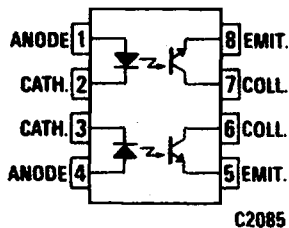
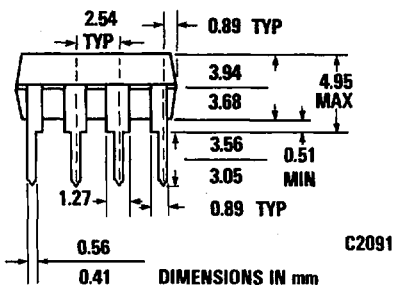
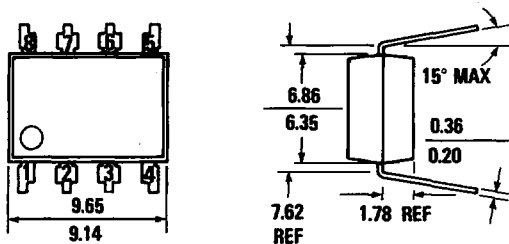

C2085

Equivalent Circuit

DESCRIPTION

The MCT6X optoisolators have two channels for high density applications. For four channel applications, two-packages fit into a standard 16-pin DIP socket. Each channel is an NPN silicon planar phototransistor optically coupled to a gallium arsenide infrared emitting diode.

FEATURES

- Two isolated channels per package
- Two packages fit into a 16 lead DIP socket
- 2500 volt isolation
- Choice of 4 current transfer ratios
- Underwriters Laboratory (U.L.) recognized File E50151

APPLICATIONS

- AC Line/Digital Logic—Isolate high voltage transients
- Digital Logic/Digital Logic—Eliminate spurious grounds
- Digital Logic/AC Triac Control—Isolate high voltage transients
- Twisted pair line receiver—Eliminate ground loop feedthrough
- Telephone/Telegraph line receiver—Isolate high voltage transients
- High Frequency Power Supply Feedback Control—Maintain floating ground
- Relay contact monitor—Isolate floating grounds and transients
- Power Supply Monitor—Isolate transients

ABSOLUTE MAXIMUM RATINGS

Storage temperature -55°C to 150°C
 Operating temperature -55°C to 100°C
 Lead temperature (soldering, 10 sec.) 250°C

TOTAL INPUT

Power dissipation at 25°C ambient 100 mW
 Derate linearly from 25°C 1.3 mW/°C

COUPLED

Input to output breakdown voltage . . 2500 volts V_{RMS}
 Total package power dissipation
 @ 25°C ambient 400 mW
 Derate linearly from 25°C 5.33 mW/°C

INPUT DIODE (each channel)

Forward current 60 mA
 Reverse voltage 3.0 V
 Peak forward current (1 μ s pulse, 300 pps) 3 A

OUTPUT TRANSISTOR (each channel)

Power dissipation @ 25°C ambient 150 mW
 Derate linearly from 25°C 2 mW/°C
 Collector current 30 mA

ELECTRO-OPTICAL CHARACTERISTICS
 (25°C Free Air Temperature Unless Otherwise Specified)

INDIVIDUAL COMPONENT CHARACTERISTICS

CHARACTERISTICS	SYMBOL	MIN.	TYP.	MAX.	UNITS	TEST CONDITION
INPUT DIODE						
Rated forward voltage	V_F		1.25	1.50	V	$I_F = 20 \text{ mA}$
Reverse voltage	V_R	3.0	25		V	$I_R = 10 \text{ } \mu\text{A}$
Reverse current	I_R		.001	10	μA	$V_R = 3.0 \text{ V}$
Junction capacitance	C_J		50		pF	$V_F = 0 \text{ V}$
OUTPUT TRANSISTOR ($I_F = 0$)						
Breakdown voltage, collector to emitter	BV_{CEO}	30	85		V	$I_C = 1.0 \text{ mA}$
Breakdown voltage, emitter to collector	BV_{ECO}	6	13		V	$I_E = 100 \text{ } \mu\text{A}$
Leakage current, collector to emitter	I_{CEO}		5	100	nA	$V_{CE} = 10 \text{ V}$
Capacitance collector to emitter	C_{CE}		8		pF	$V_{CE} = 0 \text{ V}$

TRANSFER CHARACTERISTICS

CHARACTERISTICS	SYMBOL	MIN.	TYP.	MAX.	UNITS	TEST CONDITION
COUPLED						
DC current transfer ratio (I_C/I_F) = CTR						
MCT6		20			%	$V_{CE} = 10 \text{ V}, I_F = 10 \text{ mA}$
MCT61		50			%	$V_{CE} = 5 \text{ V}, I_F = 5 \text{ mA}$
MCT62		100			%	$V_{CE} = 5 \text{ V}, I_F = 5 \text{ mA}$
MCT66		6			%	$V_{CE} = 10 \text{ V}, I_F = 10 \text{ mA}$
Saturation voltage—collector to emitter MCT6, 61, 62	$V_{CE(SAT)}$		0.2	0.4	V	$I_C = 2 \text{ mA}, I_F = 16 \text{ mA}$
MCT66			0.2	0.4	V	$I_C = 2 \text{ mA}, I_F = 40 \text{ mA}$

TRANSFER CHARACTERISTICS

CHARACTERISTICS	SYMBOL	MIN.	TYP.	MAX.	UNITS	TEST CONDITION
SWITCHING TIMES, OUTPUT TRANSISTOR						
Non-saturated rise time, fall time (Note 3)			2.4		μs	$I_C = 2 \text{ mA}, V_{CE} = 10 \text{ V}, R_L = 100\Omega$
Non-saturated rise time, fall time (Note 3)			15		μs	$I_C = 2 \text{ mA}, V_{CE} = 10 \text{ V}, R_L = 1\text{K}\Omega$
Saturated turn-on time (from 5.0V to 0.8V)			5		μs	$R_L = 2\text{K}\Omega, I_F = 40 \text{ mA}$
Saturated turn-off time (from saturation to 2.0V)			25		μs	$R_L = 2\text{K}\Omega, I_F = 40 \text{ mA}$
Bandwidth B_w			150		kHz	$I_C = 2 \text{ mA}, V_{CC} = 10 \text{ V}, R_L = 100\Omega$

ISOLATION CHARACTERISTICS

CHARACTERISTICS	SYMBOL	MIN.	TYP.	MAX.	UNITS	TEST CONDITION
Isolation voltage	$BV_{(I-O)}$	2500			V_{RMS}	$t = 1 \text{ minute}$
Isolation resistance MCT6X—	$R_{(I-O)}$	10^{11}	10^{12}		Ω	$V_{I-O} = 500 \text{ VDC}$
Breakdown voltage—channel-to-channel MCT6X			500		VDC	Relative humidity = 40% $f = 1 \text{ MHz}$
Capacitance between channels			0.4		pF	

MCT6 TYPICAL ELECTRO-OPTICAL CHARACTERISTIC CURVES

(25°C Free Air Temperature Unless Otherwise Specified)

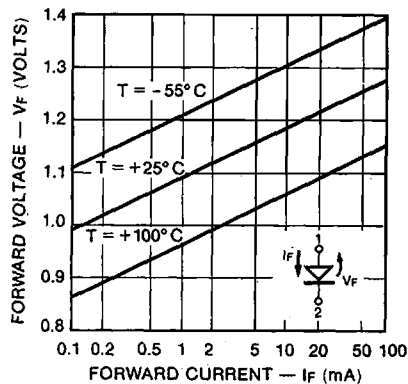

Fig. 1. Forward Voltage vs. Current

C1686

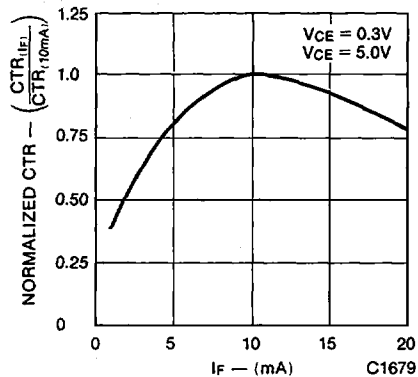

Fig. 2. Normalized CTR vs. Forward Current

C1679

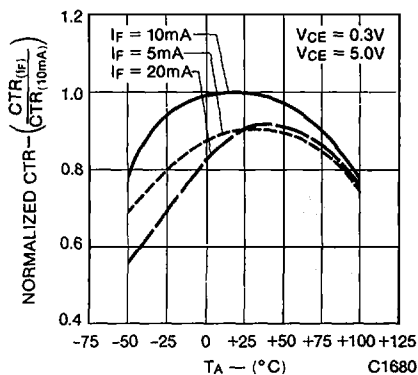

Fig. 3. Normalized CTR vs. Temperature

C1680

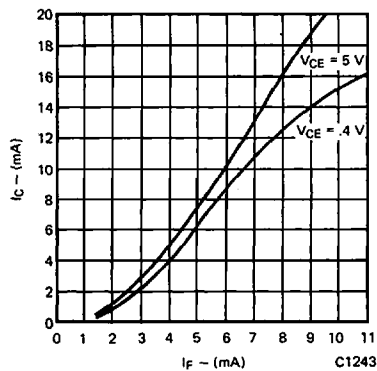

Fig. 4. Collector Current vs. Forward Current

C1243

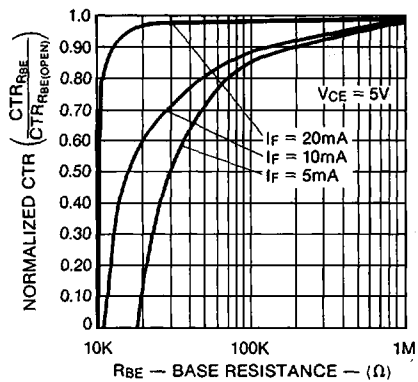

Fig. 5. CTR vs. RBE (Unsaturated)

C1681

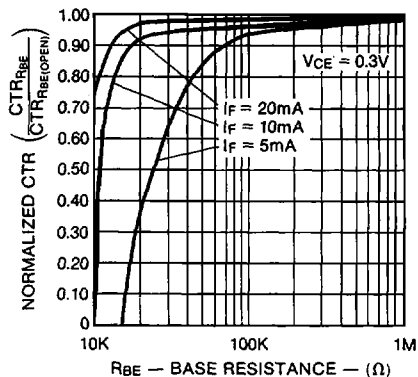

Fig. 6. CTR vs. RBE (Saturated)

C1682

MCT6 MCT61 MCT62 MCT66

MCT6 TYPICAL ELECTRO-OPTICAL CHARACTERISTIC CURVES
(25°C Free Air Temperature Unless Otherwise Specified) (Cont'd)

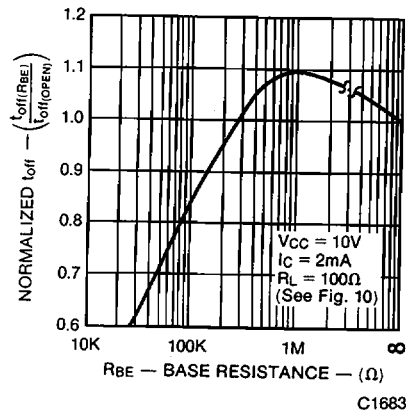

Fig. 7. Normalized T_{OFF} vs. RBE

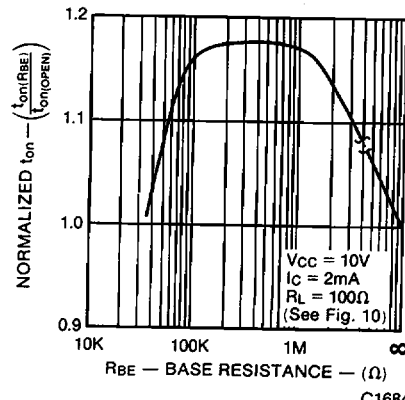

Fig. 8. Normalized T_{ON} vs. RBE

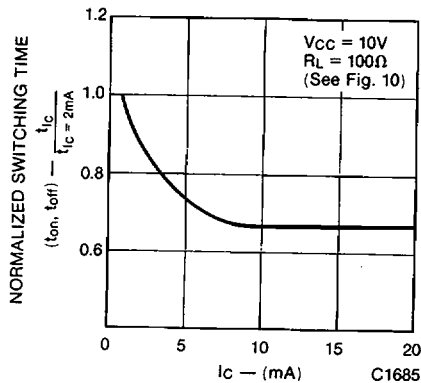

Fig. 9. Switching Time vs. I_C

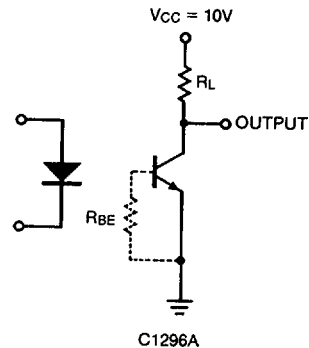

Fig. 10. Switching Time Test Circuit

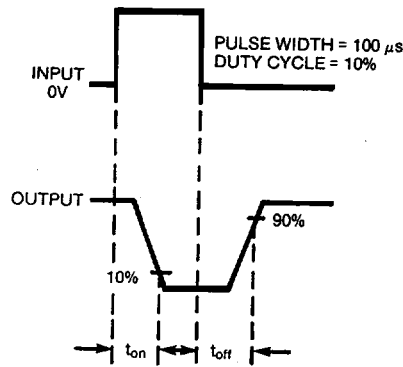
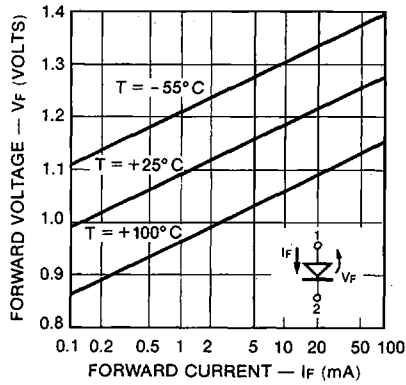

Fig. 11. Switching Time Waveforms

MCT6 MCT61 MCT62 MCT66

MCT66 TYPICAL ELECTRO-OPTICAL CHARACTERISTIC CURVES

(25°C Free Air Temperature Unless Otherwise Specified)



C1686

Fig. 1. Forward Voltage vs. Current

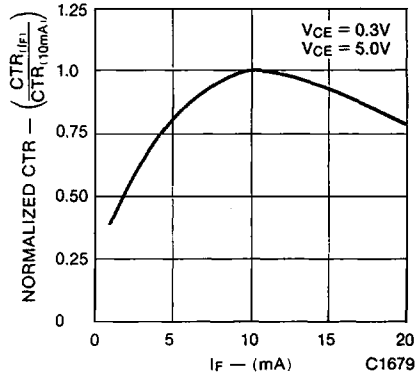

C1679

Fig. 2. Normalized CTR vs. Forward Current

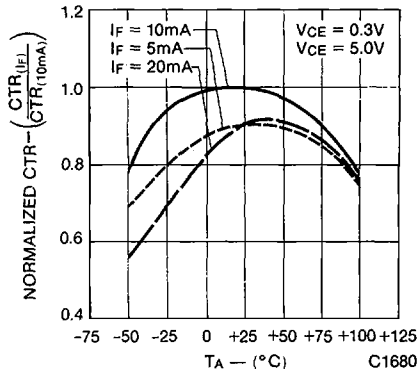

C1680

Fig. 3. Normalized CTR vs. Temperature

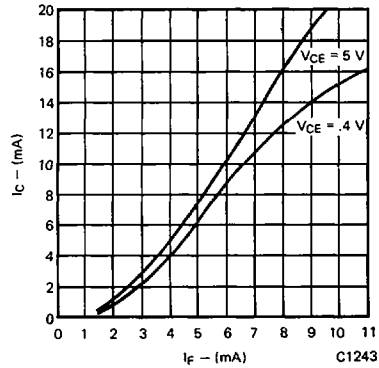

C1243

Fig. 4. Collector Current vs. Forward Current

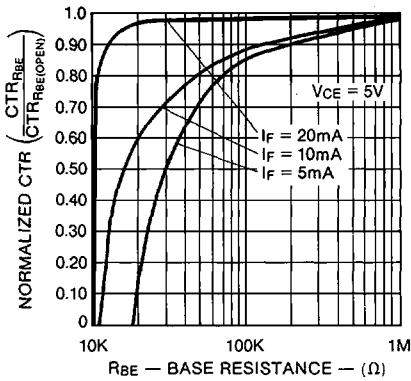

C1681

Fig. 5. CTR vs. RBE (Unsaturated)

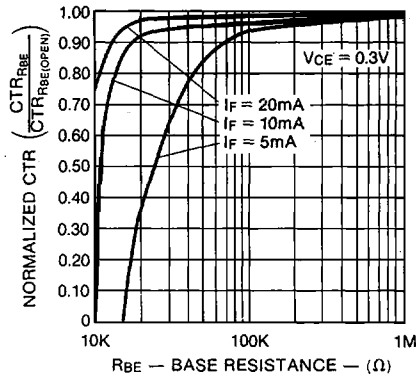

C1682

Fig. 6. CTR vs. RBE (Saturated)

MCT6 MCT61 MCT62 MCT66

MCT66 TYPICAL ELECTRO-OPTICAL CHARACTERISTIC CURVES

(25°C Free Air Temperature Unless Otherwise Specified) (Cont'd)

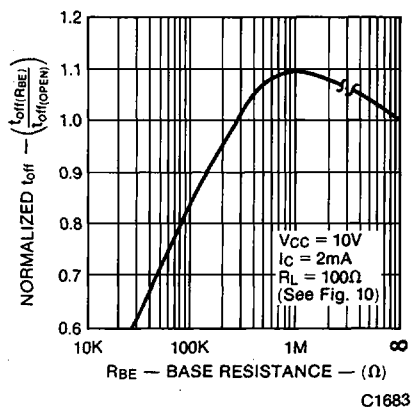

Fig. 7. Normalized T_{OFF} vs. RBE

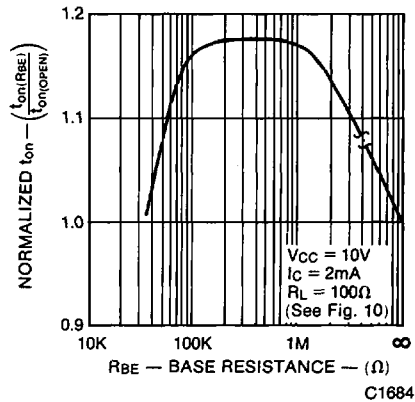

Fig. 8. Normalized T_{ON} vs. RBE

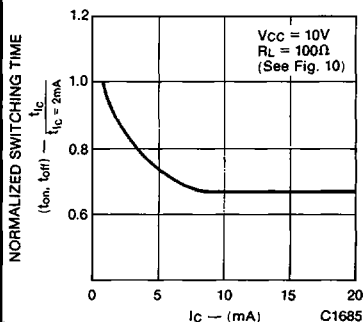

Fig. 9. Switching Time vs. I_C

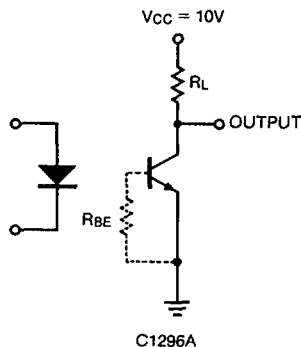

Fig. 10. Switching Time Test Circuit

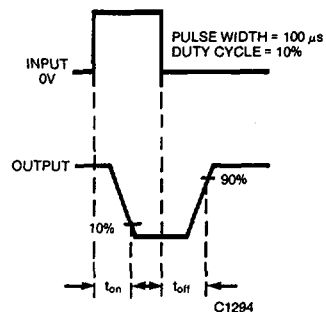

Fig. 11. Switching Time Waveforms

NOTES

1. Normalized CTR degradation = $\frac{CTR_{\sigma} \cdot CTR}{CTR_0}$
2. The current transfer ratio (I_C/I_P) is the ratio of the detector collector current to the LED input current with V_{CE} at 10 volts.
3. The frequency at which i_c is 3 dB down from the 1 kHz value.
4. Rise time (t_r) is the time required for the collector current to increase from 10% of its final value to 90%.
Fall time (t_f) is the time required for the collector current to decrease from 90% of its initial value to 10%.

MCT6 MCT61 MCT62 MCT66