

MINI-JUMPER, Post Shunt 70623 Series

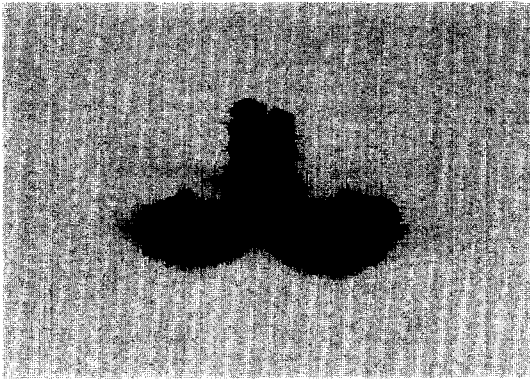

- * Glass-filled PBT (UL 94V -0)
- * Color are available, red, blue, gray, green and yellow
- * Phosphor bronze
- * Selected tin/lead in tail area selected gold contact area both over nickel overall
- * Current rating: 3 Amperes max.
- * Contact resistance: 20 milliohms max.
- * Insulation resistance: 1000 megohms min.
- * Dielectric withstanding: 250 VAC
- * Operating temperature: -55 °C ~ +105 °C

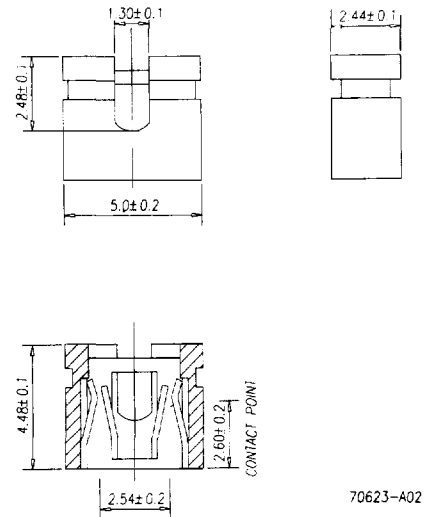
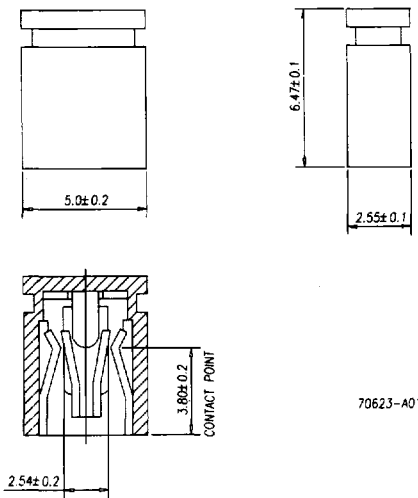

Ordering information

70623- XXX

Insulator Color : 0-Black, 1-Red, 2-Blue
3-Gray, 4-Green, 5-Yellow

MINI-JUMPER, Post Shunt 70623 Series

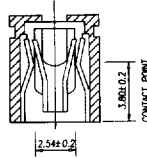
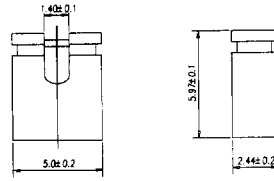

70623-A03

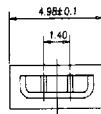
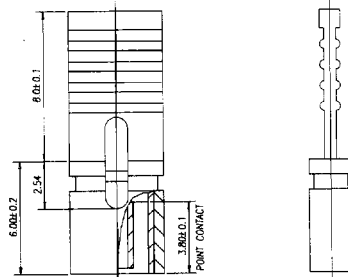

70623-A04

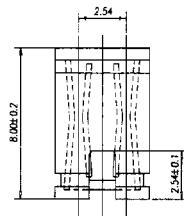
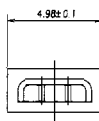

70623-A05

Ordering information 70623- XXX

Insulator Color : 0-Black, 1-Red, 2-Blue
3-Gray, 4-Green, 5-Yellow