

TAI-SAW TECHNOLOGY CO., LTD.

No. 3, Industrial 2nd Rd., Ping-Chen Industrial District,
Taoyuan, 324, Taiwan, R.O.C.

TEL: 886-3-4690038 FAX: 886-3-4697532

E-mail: tstsales@mail.taisaw.com Web: www.taisaw.com

Approval Sheet For Product Specification

Issued Date:

Product Name: SAW Filter 1560MHz SMD 3.0×3.0mm

TST Parts No.: TA0931A

Customer Parts No.: _____

Company: _____
Division: _____
Approved by : _____
Date: _____

Checked by: Asin Lin 

Approval by: Francis Chen 

Date: 2008/10/24



TAI-SAW TECHNOLOGY CO., LTD.

No. 3, Industrial 2nd Rd., Ping-Chen Industrial District,
Taoyuan, 324, Taiwan, R.O.C.

TEL: 886-3-4690038 FAX: 886-3-4697532

E-mail: tstsales@mail.taisaw.com Web: www.taisaw.com

SAW Filter 1560 MHz

MODEL NO.: TA0931A

REV. NO.:1

A. MAXIMUM RATING:

1. Input Power Level: 10 dB_m
2. DC voltage: 5 V
3. Operating Temperature: -25°C to 85°C
4. Storage Temperature: -40°C to +85° C

RoHS Compliant
Lead free
Lead-free soldering

B. CHARACTERISTICS:

Item		Specification			
		Unit	Min.	Typ.	Max.
Center Frequency	F _c	MHz	-	1560	-
Insertion Loss	1439~1441 MHz	dB	-	3.2	4.6
Amplitude ripple (p-p)	F _c ±1 MHz	dB		0.8	2.0
Rejection (referent to IL)					
	F _c -120 MHz	dB	30	45	-
	F _c +120 MHz	dB	30	45	-

Note1. No matching network required for operation at 50Ω

C. MEASUREMENT CIRCUIT:

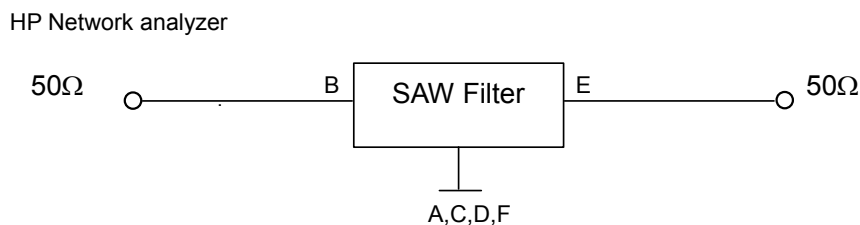

D. TRANSFER FUNCTION :

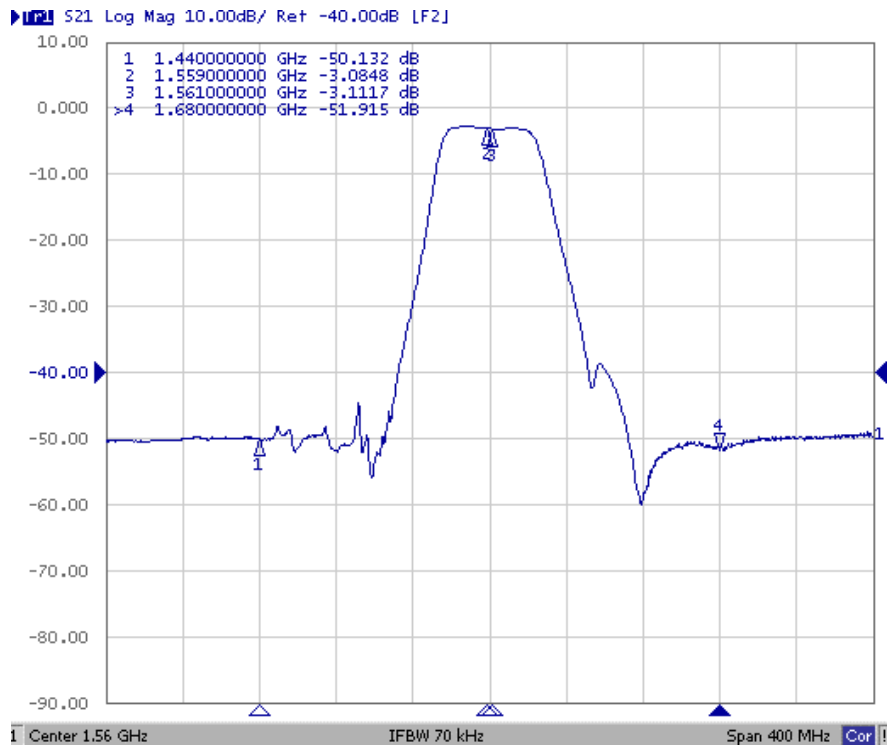
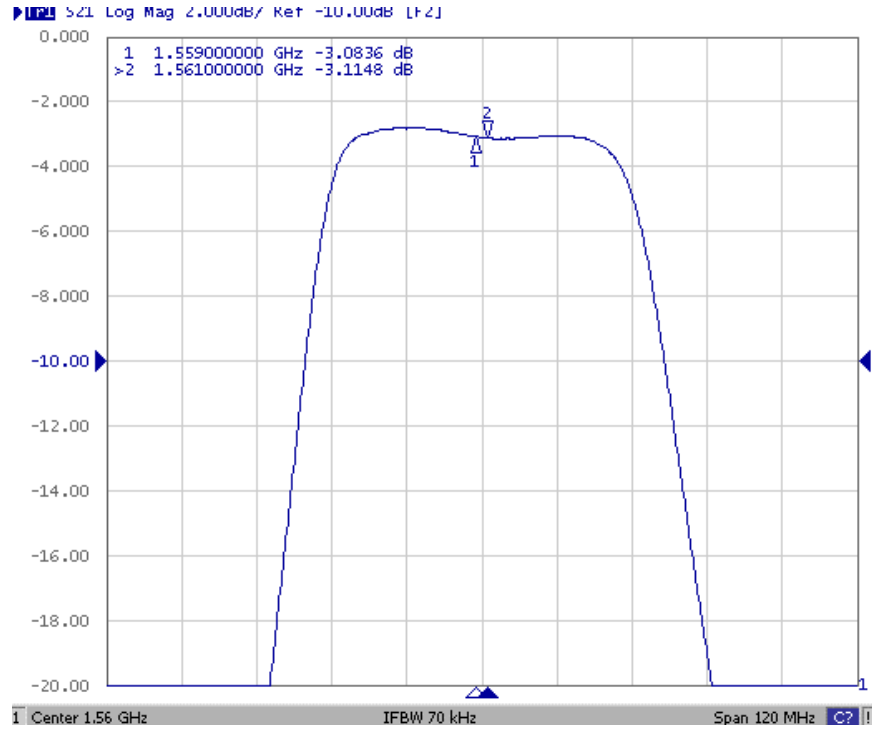

E.OUTLINE DRAWING:

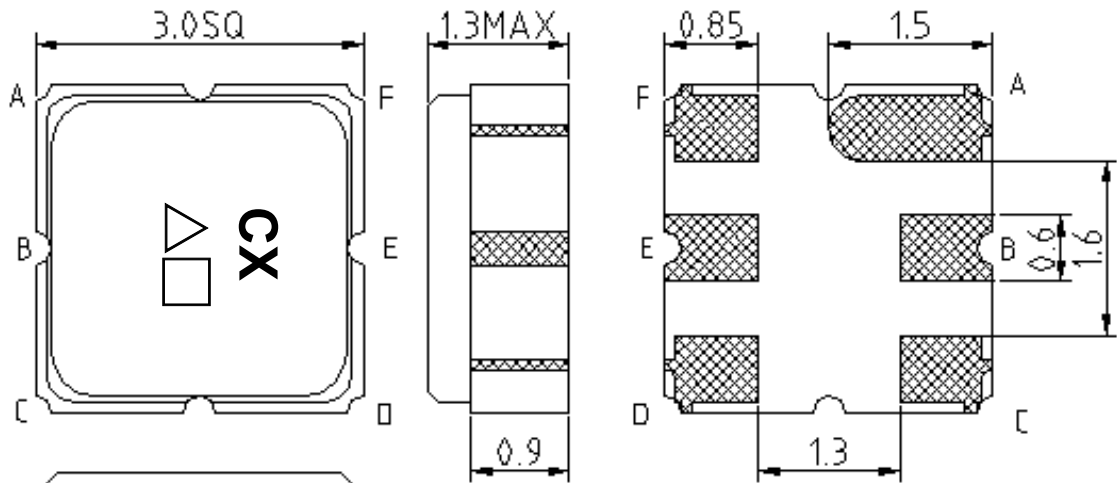

B: Input
 E: Output
 A,C,D,F: Ground
 △: Year code(8 for 2008,9 for 2009,...)
 □: Date code code (Provided by planer each year)
 Unit: mm

F.PCB FOOTPRINT:

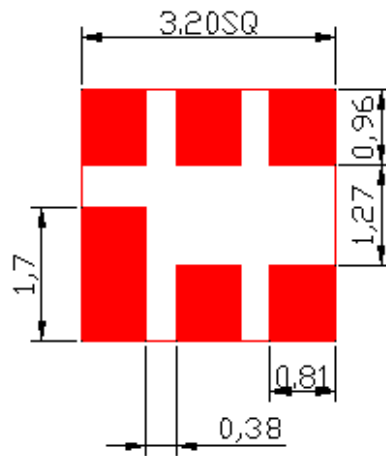

G. PACKING:

1. REEL DIMENSION

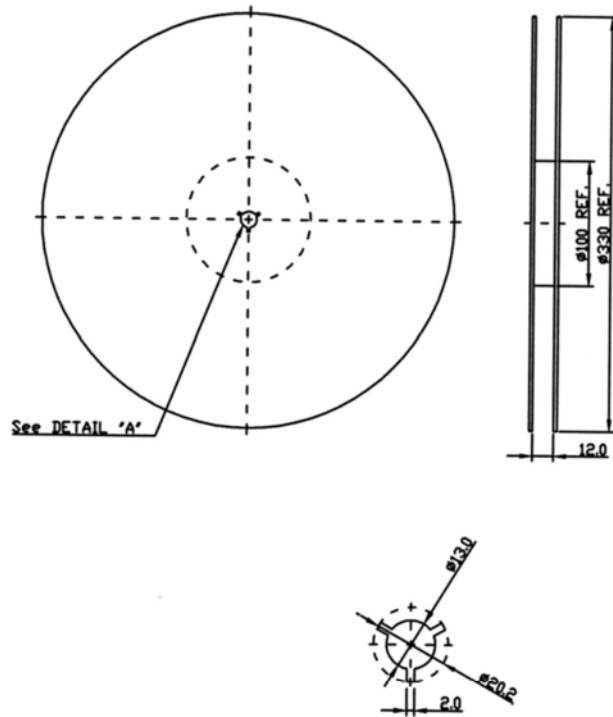

2. TAPE DIMENSION

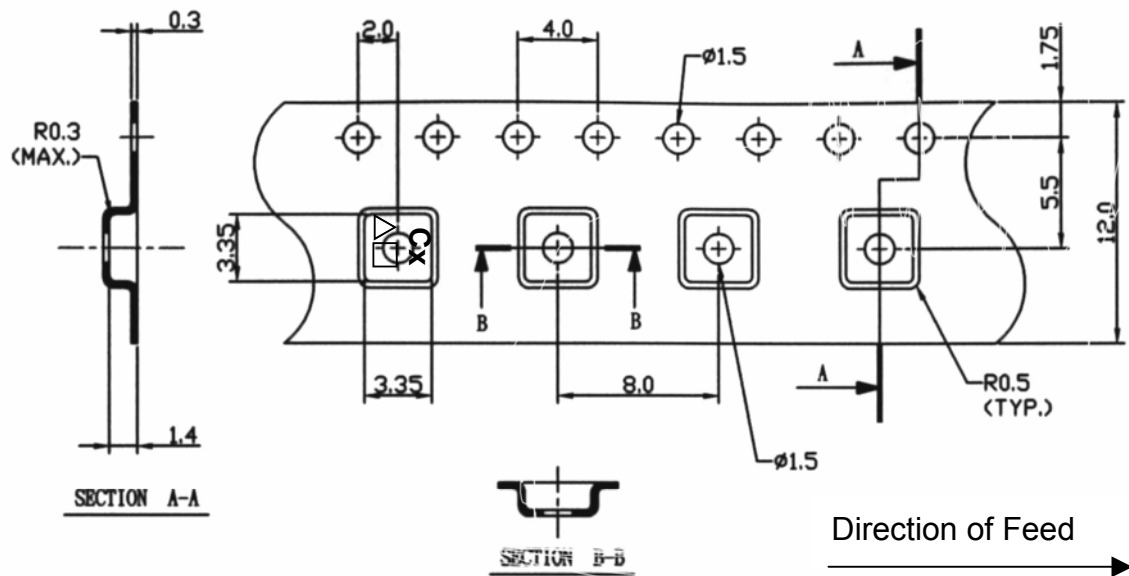

H.RECOMMENDED REFLOW PROFILE:

