

For AC/DC Dual-channel / Purpose General-purpose Type Optical MOS Relay

OCM4 □ 8, 4 □ 9 series

- Space saving ▶ Dual channels mounted in the 6-pin DIP space
- On resistance ▶ 4~70 Ω
- Load current ▶ 200~50 mA
- Recommended input current ▶ 10 mA

■ Absolute maximum ratings

(Ambient temperature $T_a = 25^\circ\text{C}$)

Product name				OCM408 OCM409	OCM418 OCM419	OCM428 OCM429	OCM438 OCM439	OCM448 OCM449
Item	Symbol	Condition	Unit					
Input characteristics	Continuous forward current	I_F		50				
	Derating factor of continuous forward current	ΔI_F		Refer to [Derating Factor of Continuous Forward current] of characteristics data				
	Peak forward current	I_{FM}	Pulse width 100 μs Cycle 10ms	0.5				
	Reverse voltage	V_R		5				
	Power dissipation	P_{DL}		75				
Output characteristics	Load voltage	V_{OFF}		60	100	200	350	400
	Load current	I_{ON}		200	150	100	75	50
	Derating factor of load current	ΔI_{ON}		Refer to [Derating Factor of Load Current] of characteristics data				
	Surge load current	I_{SUG}	Pulse width 1ms 1shot	0.5				
	Power dissipation	P_D		300				
Total power dissipation			P_{tot}	325				
Isolation voltage	V_{IO}		V(rms)	1500				
				OCM408	OCM418	OCM428	OCM438	OCM448
				4000				
			OCM409	OCM419	OCM429	OCM439	OCM449	
Operating temperature	T_{opr}		$-40 \sim +85$					
Storage temperature	T_{stg}		$-40 \sim +100$					

APPLICATIONS

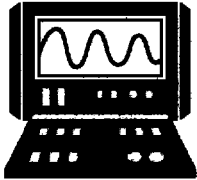

Measurement equipment



Security equipment



Office automation system



Industrial equipment

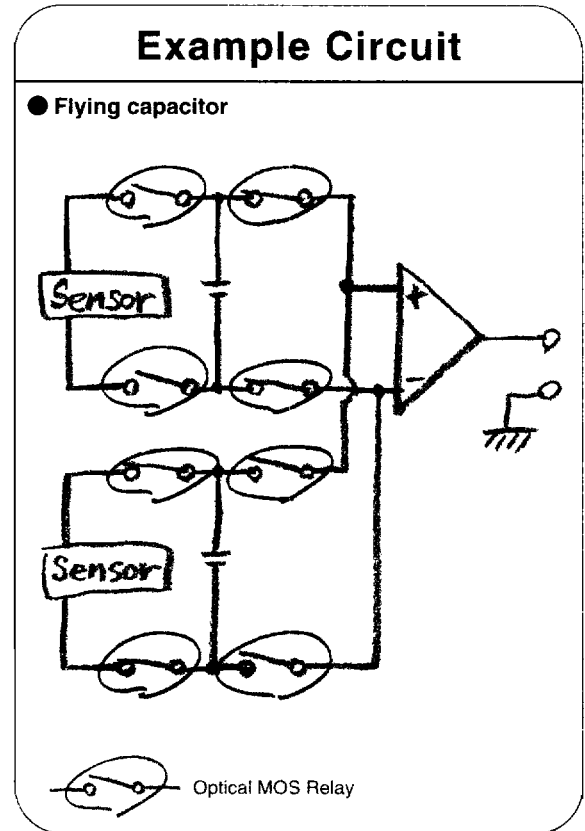

Electrical characteristics

(Ambient temperature Ta=25°C)

Product name					OCM408 OCM409	OCM418 OCM419	OCM428 OCM429	OCM438 OCM439	OCM448 OCM449	
Item	Symbol	Condition		Unit						
Input characteristics	Forward voltage	V _F	I _F =10mA	MIN			1.0			
				MAX	V		1.3			
	Reverse voltage	I _R	V _R =5V	MAX	μA		10			
	Operation input current ^{*1}	I _{FA}	I _{ON} =100mA	MAX	mA		5			
Recovery input current	I _{FR}	V _{OFF} =Rating I _{ON} =100 μA	MIN	mA		0.2				
Output characteristics	On-resistance	R _{ON}	I _F =10mA I _{ON} =100mA OCM408,409,418,419 I _{ON} =Rating ^{*4} Time to flow current is within one second	MIN		4.0	5.0	12	25	50
				MAX	Ω	5.0	7.0	16	35	70
	Off-state leakage current ^{*2}	I _{OFF}	V _{OFF} =Rating	MAX	μA		1.0			
Output terminal capacitance	C _{OUT}	V _{OFF} =50V f=1MHz	TYP	pF	15	10	8	6	5	
Input-to-output capacitance	C _{IO}	f=1MHz	TYP	pF			1.3			
Coupling characteristics	Turn on time ^{*3}	t _{on}	I _F =10mA I _{ON} =100mA OCM408,409 OCM418,419 OCM428,429	TYP			0.3			
				MAX	ms		1.0			
Coupling characteristics	Turn off time ^{*3}	t _{off}	I _{off} =50mA OCM438,439 OCM448,449	TYP			0.2			
				MAX	ms		1.0			

*1 : Can correspond to special specification I_{FA} < 3.0mA

*2 : Can correspond to special specification I_{OFF} < 1.0μA

*3 : Can correspond to special specification t_{on} / t_{off} < 0.5ms

*4 : Except (OCM408, 409, 418, 419)

OCM4 8, 4 9 series Characteristics Curves

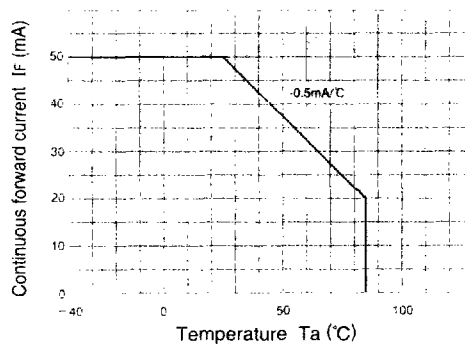

Derating factor of continuous forward current

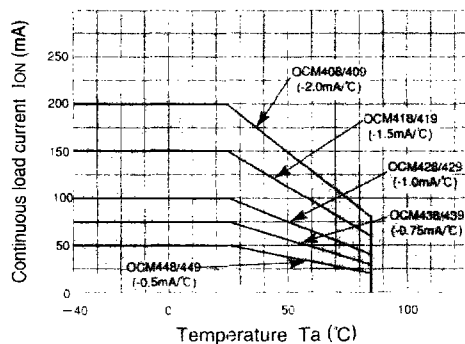

Derating factor of load current

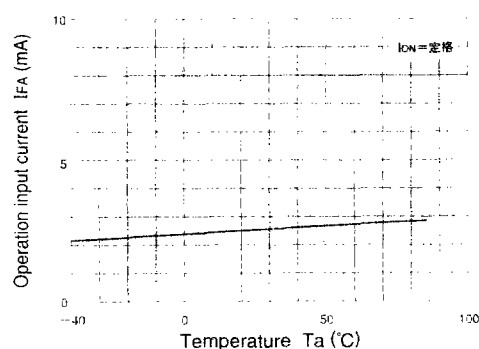

Operation input current vs. Ambient temperature

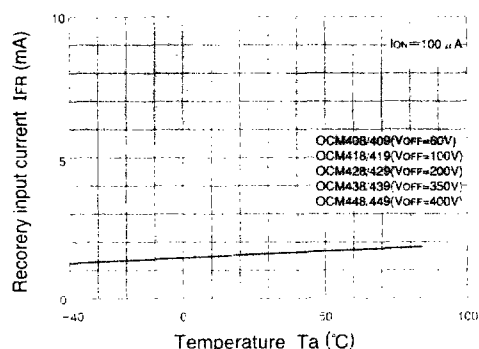

Recovery input current vs. Ambient temperature

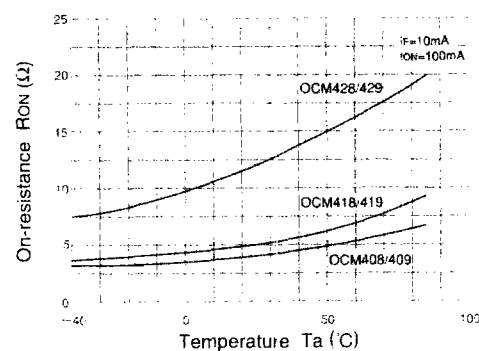

On-resistance vs. Ambient temperature-1

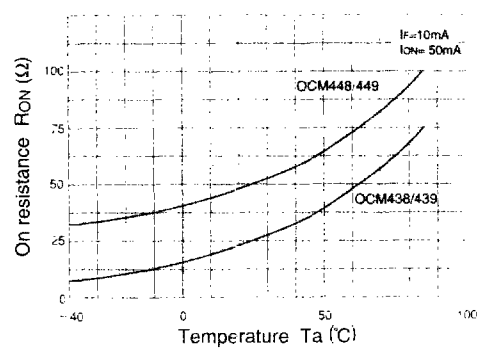

On-resistance vs. Ambient temperature-2

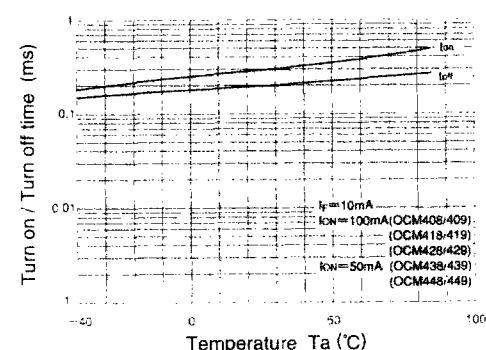

Turn on/Turn off time vs. Ambient temperature

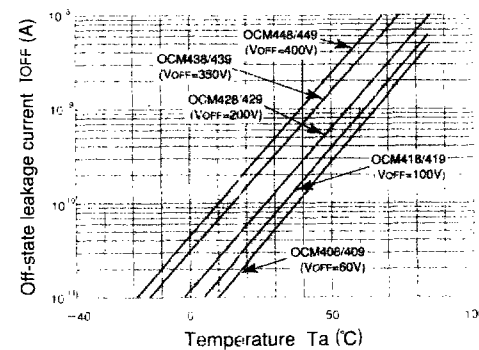

Off-state leakage current vs. Ambient temperature

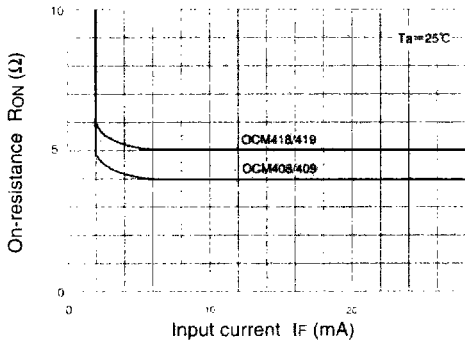

Continuous forward current vs. On-resistance-1

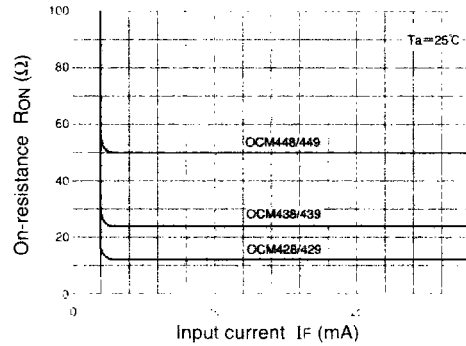

Continuous forward current vs. On-resistance-2

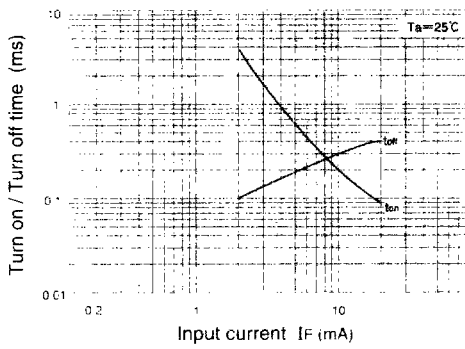

Continuous forward current vs. Turn on/Turn off time

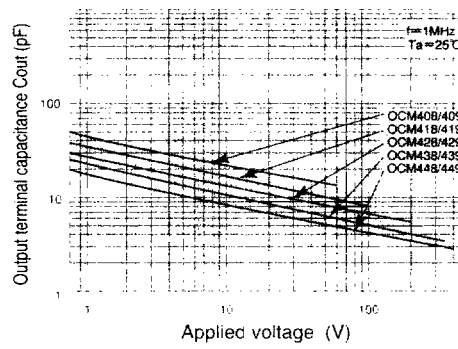

Output terminal capacitance vs. Applied voltage

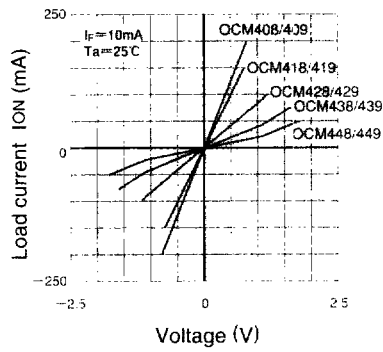

Load current vs. Voltage