

High Luminous Efficacy  
Cool White LED Emitter  
**LZC-00CW40**



## Key Features

- High Luminous Efficacy 40W Cool White LED
- Small foot print – 9.0mm x 9.0mm x 5.4mm
- Surface mount ceramic package with integrated glass lens
- Extremely low Thermal Resistance (0.7°C/W)
- Ultra high Luminous Flux density
- Spatial color uniformity across radiation pattern
- New industry standard for Lumen Maintenance (>90% at 100,000 Hours)
- JEDEC Level 1 for Moisture Sensitivity Level
- Lead (Pb) free and RoHS compliant
- Reflow solderable (up to 6 cycles)
- Emitter available on Serial MCPCB (optional)
- Recommend use with LL-3T08 lens family to provide standard beam patterns suitable for general lighting applications

## Typical Applications

- General lighting
- Down lighting
- Architectural lighting
- Street lighting
- Stage and Studio lighting
- Refrigeration lighting
- Portable lighting

## Description

The LZC-00CW40 Cool White LED emitter provides 40W power in an extremely small package. With a small 9.0mm x 9.0mm x 5.4mm footprint, this package provides exceptional luminous flux density. LedEngin's patent-pending thermally insulated phosphor layer provides spatial color uniformity across the radiation pattern and a consistent CCT over time and temperature. The high quality materials used in the package are chosen to optimize light output and minimize stresses which results in superior reliability and lumen maintenance. The robust product design thrives in outdoor applications with high ambient temperatures and high humidity.

## Table of Contents

Product Nomenclature . . . . .	3
Luminous Flux Binning . . . . .	3
Forward Voltage Binning . . . . .	3
Cool White Chromaticity Binning . . . . .	4
IPC/JEDEC Moisture Sensitivity . . . . .	5
Average Lumen Maintenance Projections . . . . .	5
Typical Radiation Pattern . . . . .	5
Absolute Maximum Ratings . . . . .	6
Optical Characteristics . . . . .	6
Electrical Characteristics . . . . .	6
Mechanical Dimensions . . . . .	7
Pin-Out . . . . .	7
Recommended Solder Pad Layout . . . . .	7
Reflow Soldering Profile . . . . .	8
Typical Relative Spectral Power Distribution . . . . .	8
Typical Relative Light Output . . . . .	9
Typical Relative Light Output over Temperature . . . . .	9
Typical Forward Current Characteristics . . . . .	10
Current Derating Curves . . . . .	10
MCPCB Option Configuration . . . . .	11
Company Information . . . . .	12

## Product Nomenclature

The LZ Series part number designation is defined as follows:



Where:

- A – designates the number of LED die in the package (“C” for 40W)
- B – designates the package level (“0” for Emitter; “7” for serial MCPCB)
- C – designates the radiation pattern (“0” for Lambertian)
- D and E – designate the color (“CW” for Cool White: 4750 K < CCT < 7200 K)
- F and G – designate the Power (“40” for 40W typical rating)
- H – designates the Luminous Flux bin (See Table 1)
- J and K – designate the CCT bin groups (see Figure 1 and Table 3)
- L – designates the  $V_F$  bin (See Table 2)

## Luminous Flux Bins

Table 1:

Bin Code	Minimum Luminous Flux ( $\Phi_V$ ) @ $I_F = 700\text{mA}$ <sup>[1,2]</sup> (lm)	Maximum Luminous Flux ( $\Phi_V$ ) @ $I_F = 700\text{mA}$ <sup>[1,2]</sup> (lm)	Typical Luminous Flux ( $\Phi_V$ ) @ $I_F = 1000\text{mA}$ <sup>[2]</sup> (lm)
X	1,085	1,357	1,540
Y	1,357	1,696	1,920
Z	1,696	2,120	2,400

Notes for Table 1:

1. Luminous flux performance guaranteed within published operating conditions. LedEngin maintains a tolerance of  $\pm 10\%$  on flux measurements.
2. Luminous Flux typical value is for all 12 LED dice operating concurrently at rated current.

## Forward Voltage Bins

Table 2:

Bin Code	Minimum Forward Voltage ( $V_F$ ) @ $I_F = 700\text{mA}$ <sup>[1,2]</sup> (V)	Maximum Forward Voltage ( $V_F$ ) @ $I_F = 700\text{mA}$ <sup>[1,2]</sup> (V)
F	38.40	41.28
G	41.28	44.16
H	44.16	47.04
J	47.04	49.92

Notes for Table 2:

1. LedEngin maintains a tolerance of  $\pm 0.48\text{V}$  for forward voltage measurements.
2. Forward Voltage is binned with 12 LED dice connected in series. The actual LED is configured with two strings of 6 dice in series.

## Cool White Chromaticity Groups

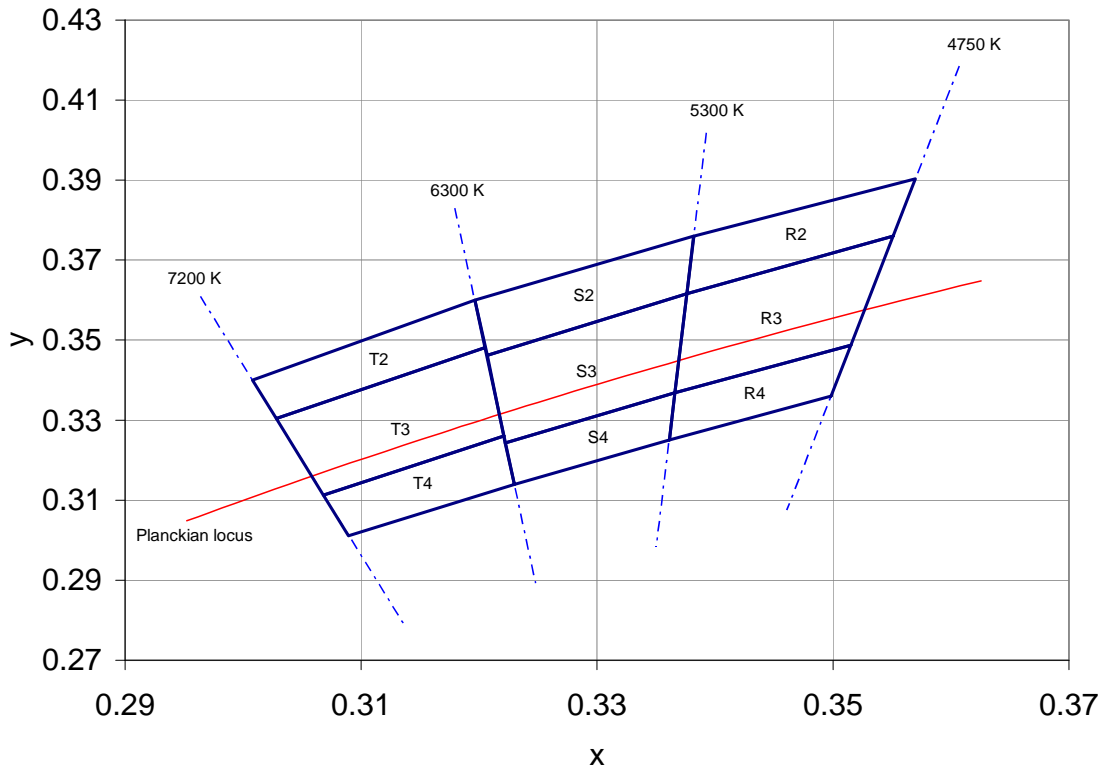

Figure 1: Standard Chromaticity Groups plotted on excerpt from the CIE 1931 (2°) x-y Chromaticity Diagram. Coordinates are listed below in Table 3.

## Cool White Chromaticity Coordinates

Table 3:

Bin Code	x	y	Typical CCT (K)	Bin Code	x	y	Typical CCT (K)	Bin Code	x	y	Typical CCT (K)
T2	0.3205	0.3481	6750	S2	0.3376	0.3616	5800	R2	0.3551	0.3760	5000
	0.3196	0.3600			0.3382	0.3760			0.3570	0.3903	
	0.3008	0.3400			0.3196	0.3600			0.3382	0.3760	
	0.3028	0.3304			0.3207	0.3462			0.3376	0.3616	
T3	0.3221	0.3261	6750	S3	0.3366	0.3369	5800	R3	0.3515	0.3487	5000
	0.3205	0.3481			0.3376	0.3616			0.3551	0.3760	
	0.3028	0.3304			0.3207	0.3462			0.3376	0.3616	
	0.3068	0.3113			0.3222	0.3243			0.3366	0.3369	
T4	0.3230	0.3140	6750	S4	0.3361	0.3251	5800	R4	0.3498	0.3360	5000
	0.3221	0.3261			0.3366	0.3369			0.3515	0.3487	
	0.3068	0.3113			0.3222	0.3243			0.3366	0.3369	
	0.3089	0.3011			0.3230	0.3140			0.3361	0.3251	

## IPC/JEDEC Moisture Sensitivity Level

Table 4 - IPC/JEDEC J-STD-20.1 MSL Classification:

Level	Soak Requirements					
	Floor Life		Standard		Accelerated	
	Time	Conditions	Time (hrs)	Conditions	Time (hrs)	Conditions
1	unlimited	≤ 30°C/ 85% RH	168 +5/-0	85°C/ 85% RH	n/a	n/a

Notes for Table 4:

- The standard soak time includes a default value of 24 hours for semiconductor manufacturer's exposure time (MET) between bake and bag and includes the maximum time allowed out of the bag at the distributor's facility.

## Average Lumen Maintenance Projections

Lumen maintenance generally describes the ability of a lamp to retain its output over time. The useful lifetime for solid state lighting devices (Power LEDs) is also defined as Lumen Maintenance, with the percentage of the original light output remaining at a defined time period.

Based on long-term WHTOL testing, LedEngin projects that the LZ Series will deliver, on average, 90% Lumen Maintenance at 100,000 hours of operation at a forward current of 700 mA per die. This projection is based on constant current operation with junction temperature maintained at or below 125°C.

## Typical Radiation Pattern

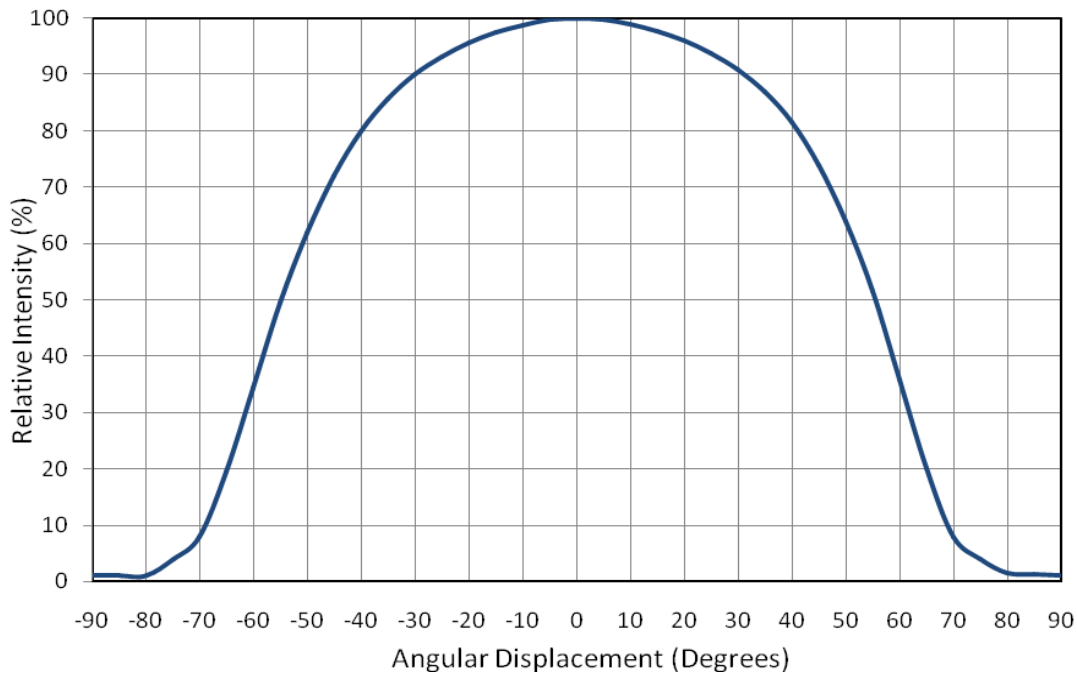

Figure 2: Typical representative spatial radiation pattern.

## Absolute Maximum Ratings

Table 5:

Parameter	Symbol	Value	Unit
DC Forward Current <sup>[1]</sup>	$I_F$	1000	mA
Peak Pulsed Forward Current <sup>[2]</sup>	$I_{FP}$	1500	mA
Reverse Voltage	$V_R$	See Note 3	V
Storage Temperature	$T_{stg}$	-40 ~ +150	°C
Junction Temperature	$T_J$	150	°C
Soldering Temperature <sup>[4]</sup>	$T_{sol}$	260	°C
Allowable Reflow Cycles		6	
ESD Sensitivity <sup>[5]</sup>		> 8,000 V HBM Class 3B JESD22-A114-D	

Notes for Table 5:

- Maximum DC forward current (per die) is determined by the overall thermal resistance and ambient temperature. Follow the curves in Figure 10 for current derating.
- Pulse forward current conditions: Pulse Width  $\leq$  10msec and Duty cycle  $\leq$  10%.
- LEDs are not designed to be reverse biased.
- Solder conditions per JEDEC 020D. See Reflow Soldering Profile Figure 5.
- LedEngin recommends taking reasonable precautions towards possible ESD damages and handling the LZ4-00CW40 in an electrostatic protected area (EPA). An EPA may be adequately protected by ESD controls as outlined in ANSI/ESD S6.1.

## Optical Characteristics @ $T_C = 25^\circ\text{C}$

Table 6:

Parameter	Symbol	Typical	Unit
Luminous Flux (@ $I_F = 700\text{mA}$ ) <sup>[1]</sup>	$\Phi_V$	1900	lm
Luminous Flux (@ $I_F = 1000\text{mA}$ ) <sup>[1]</sup>	$\Phi_V$	2400	lm
Luminous Efficacy (@ $I_F = 350\text{mA}$ )		88	lm/W
Correlated Color Temperature	CCT	5500	K
Chromaticity Coordinates	x,y	0.332, 0.342	
Color Rendering Index (CRI)	$R_a$	75	
Viewing Angle <sup>[2]</sup>	$2\Theta_{1/2}$	110	Degrees

Notes for Table 6:

- Luminous flux typical value is for all 12 LED dice operating concurrently at rated current.
- Viewing Angle is the off-axis angle from emitter centerline where the luminous intensity is  $\frac{1}{2}$  of the peak value.

## Electrical Characteristics @ $T_C = 25^\circ\text{C}$

Table 7:

Parameter	Symbol	Typical	Unit
Forward Voltage (@ $I_F = 700\text{mA}$ ) <sup>[1]</sup>	$V_F$	42.0	V
Forward Voltage (@ $I_F = 1000\text{mA}$ ) <sup>[1]</sup>	$V_F$	43.8	V
Temperature Coefficient of Forward Voltage <sup>[1]</sup>	$\Delta V_F / \Delta T_J$	-33.6	mV/°C
Thermal Resistance (Junction to Case)	$R\Theta_{J-C}$	0.7	°C/W

Notes for Table 7:

- Forward Voltage is binned with 12 LED dice connected in series. The actual LED is configured with two strings of 6 dice in series.

## Mechanical Dimensions (mm)

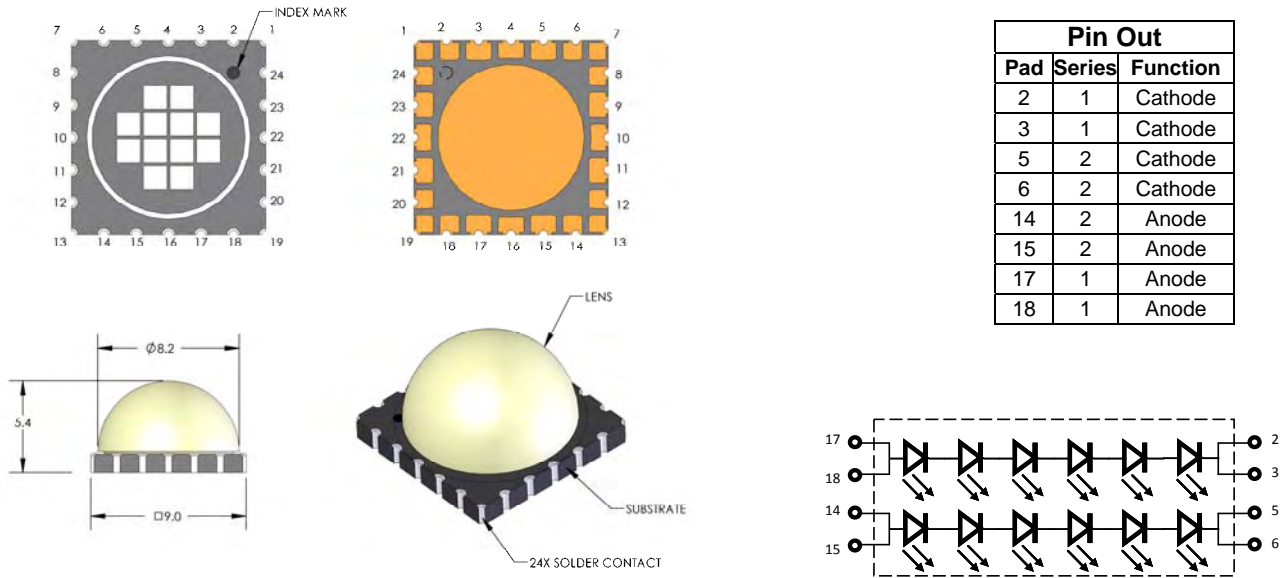

Figure 3: Package outline drawing.

Notes for Figure 3:

1. Unless otherwise noted, the tolerance =  $\pm 0.20$  mm.

## Recommended Solder Pad Layout (mm)

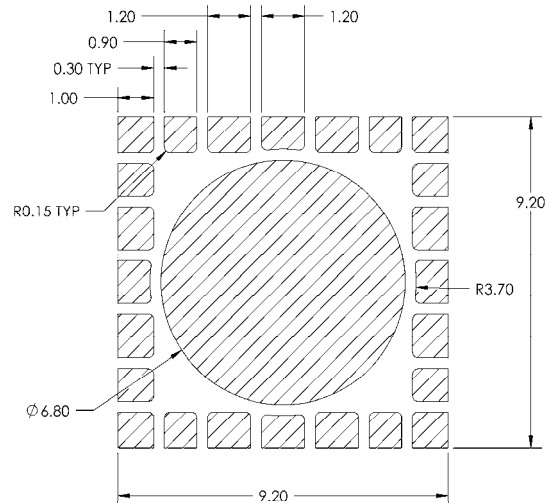

Figure 4: Recommended solder mask opening (hatched area) for anode, cathode, and thermal pad.

Note for Figure 4:

1. Unless otherwise noted, the tolerance =  $\pm 0.20$  mm.

## Reflow Soldering Profile

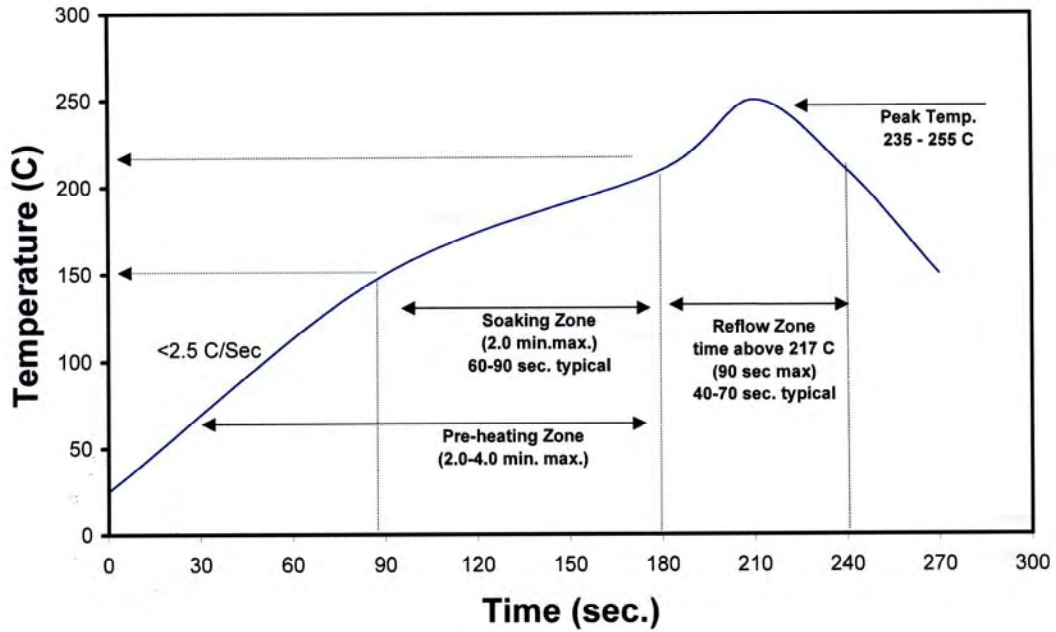

Figure 5: Reflow soldering profile for lead free soldering.

## Typical Relative Spectral Power Distribution

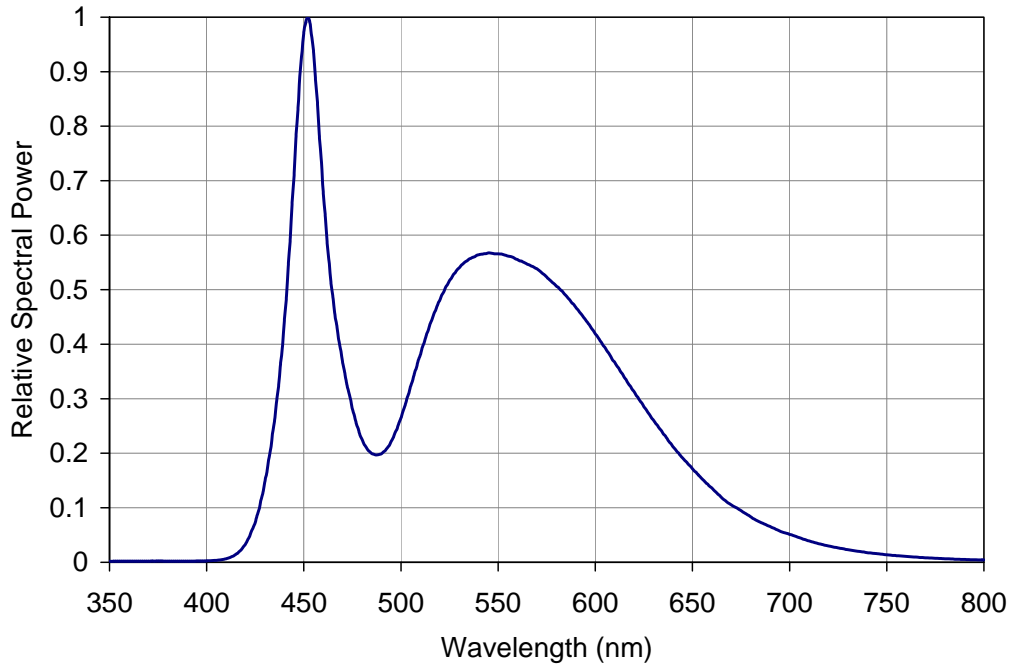

Figure 6: Typical relative spectral power vs. wavelength @  $T_c = 25^\circ\text{C}$ .



## Typical Relative Light Output

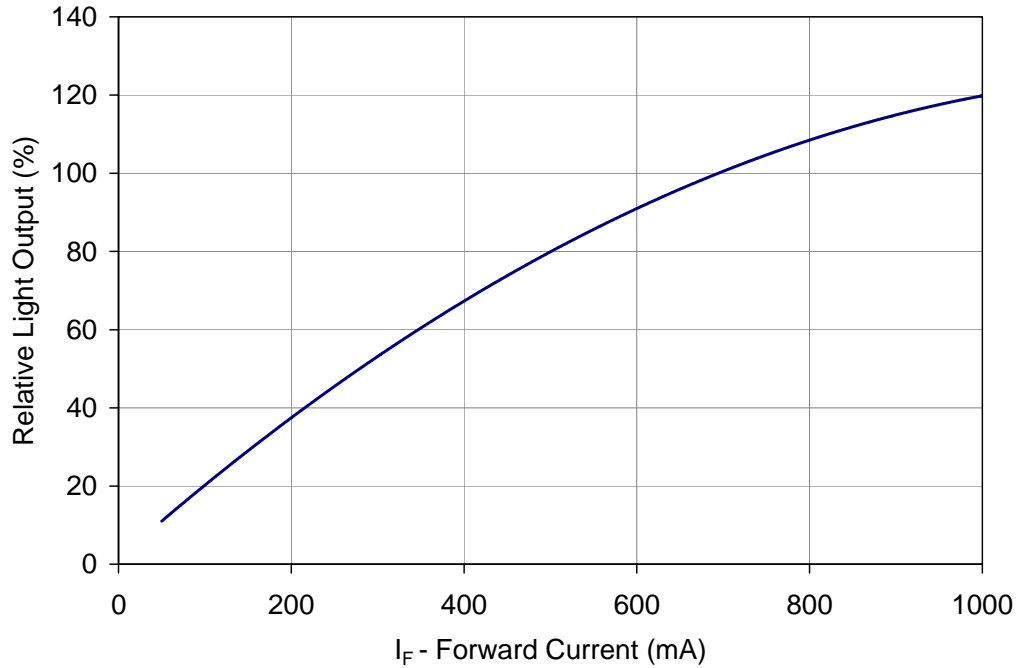

Figure 7: Typical relative light output vs. forward current @  $T_C = 25^\circ\text{C}$ .

Notes for Figure 7:

1. Luminous Flux typical value is for all 12 LED dice operating concurrently at rated current.

## Typical Relative Light Output over Temperature

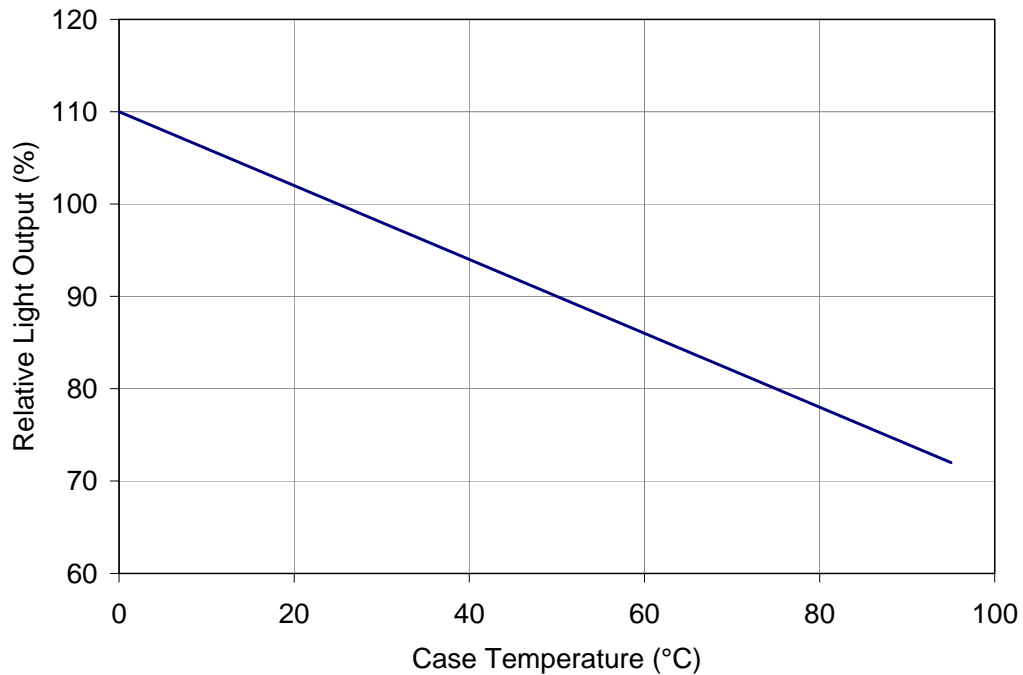

Figure 8: Typical relative light output vs. case temperature.

Notes for Figure 8:

1. Luminous Flux typical value is for all 12 LED dice operating concurrently at rated current.

## Typical Forward Current Characteristics

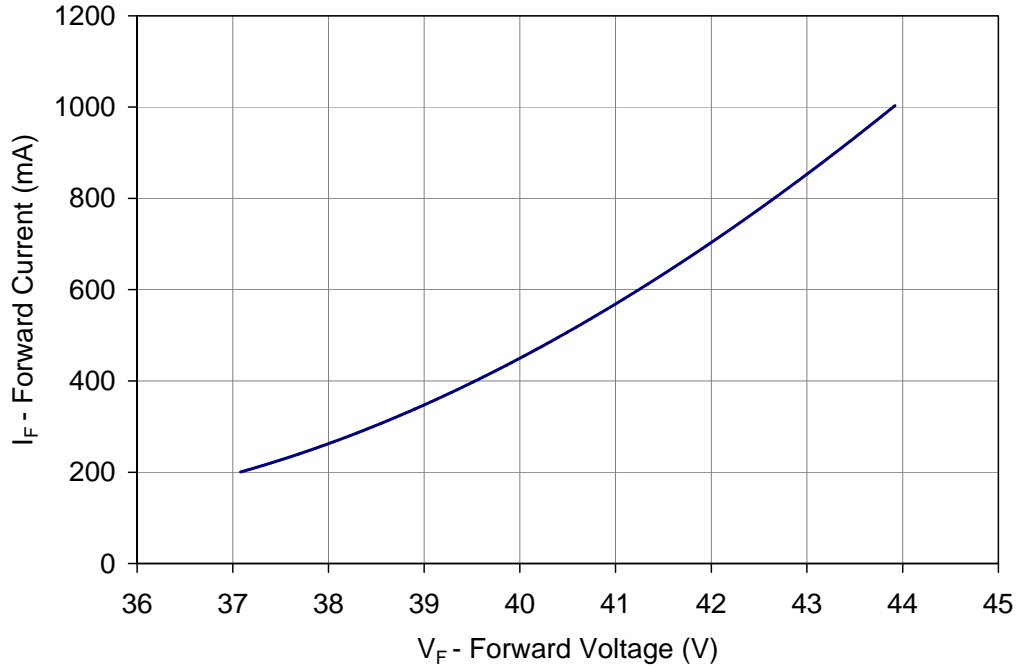

Figure 9: Typical forward current vs. forward voltage @  $T_c = 25^\circ\text{C}$ .

Note for Figure 9:

1. Forward Voltage assumes 12 LED dice connected in series. The actual LED is configured with two strings of 6 dice in series.

## Current Derating

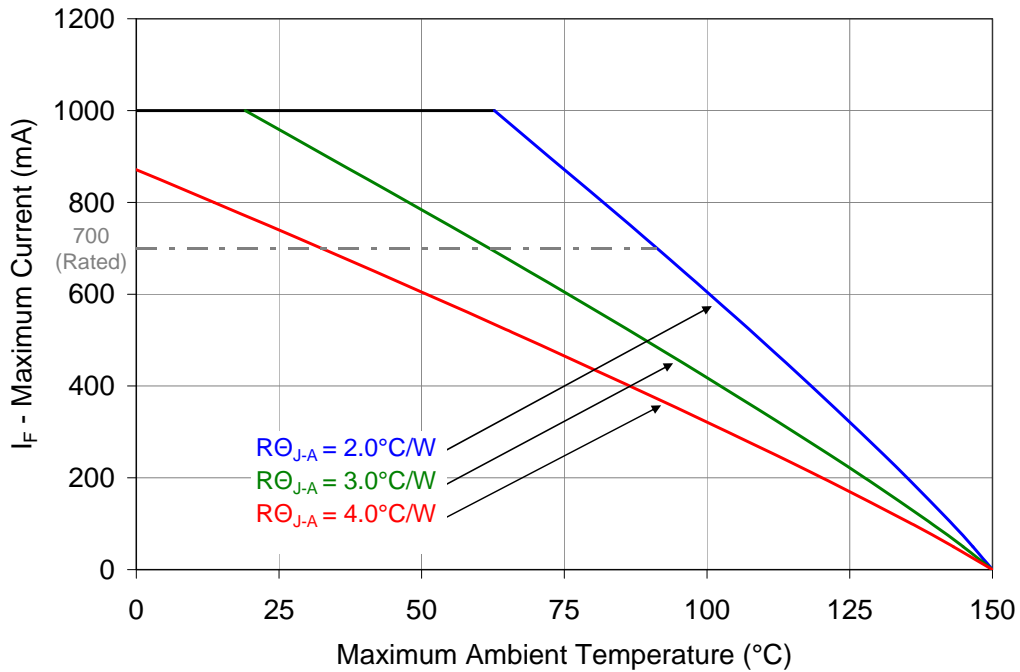

Figure 10: Maximum forward current vs. ambient temperature based on  $T_{J(\text{MAX})} = 150^\circ\text{C}$ .

Notes for Figure 10:

1. Maximum current assumes that all LED dice are operating concurrently at the same current.
2.  $R\theta_{J-C}$  [Junction to Case Thermal Resistance] for the LZC-00CW40 is typically  $0.7^\circ\text{C/W}$ .
3.  $R\theta_{J-A}$  [Junction to Ambient Thermal Resistance] =  $R\theta_{J-C} + R\theta_{C-A}$  [Case to Ambient Thermal Resistance].

## MCPCB Option – Serial configuration LZC-70xW40

- Typical Thermal Resistance for MCPCB adds only 0.8°C/W
- Serial configuration allows for easy driver control
- MCPCB contains Zener Diodes for enhanced ESD protection

The LZC-70xx40 Serial MCPCB option provides a convenient method to mount LedEngin’s single color 40W emitters. The six recessed features allow the use of M3 or #4 screws to attach the MCPCB to a heat sink. The MCPCB also contains Zener diodes for enhanced ESD protection.

### R<sub>ΘJ-B</sub> Lookup Table

Table 8:

Product	Typical Emitter R <sub>ΘJ-C</sub>	+	Typical MCPCB R <sub>ΘC-B</sub>	=	Typical Emitter + MCPCB R <sub>ΘJ-B</sub> <sup>[1]</sup>
40W	0.7°C/W	+	0.8°C/W	=	1.5°C/W

### Serial MCPCB Mechanical Dimensions (mm)

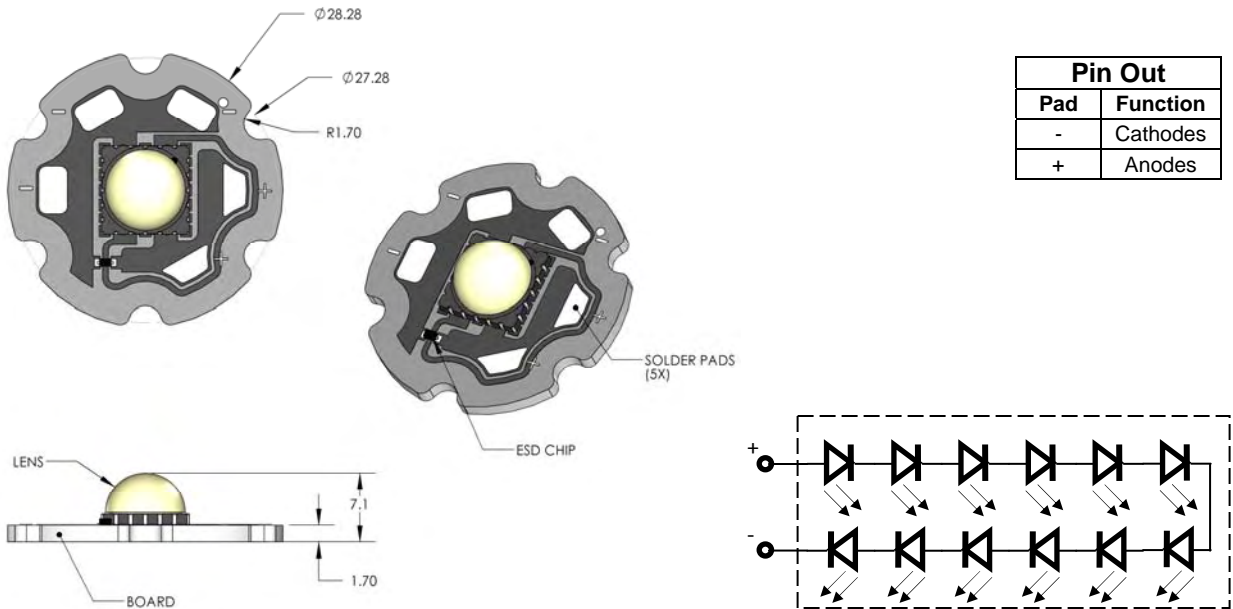

Figure 11: Standard MCPCB outline dimensions (mm).

Note for Figure 1:

1. Unless otherwise noted, the tolerance = ± 0.20 mm.
2. Slots in MCPCB are for M3 or #4 mounting screws.
3. LedEngin recommends using plastic washers to electrically insulate screws from solder pads and electrical traces.
4. LedEngin recommends using thermally conductive tape or adhesives when attaching MCPCB to a heat sink.

## Company Information

LedEngin, Inc. is a Silicon Valley based solid-state lighting company specializing in the development and manufacturing of unprecedented high-power LED emitters, modules and replacement lamps. LedEngin's packaging technologies lead the industry with products that feature lowest thermal resistance, highest flux density and consummate reliability, enabling compact and efficient solid state lighting solutions.

LedEngin's LED emitters range from 3W to 40W with ultra-compact footprints and are available in single color products including Cool White, Neutral White, Warm White, Red, Green, Blue, Amber, Deep Red, Far Red, Dental Blue and UV as well as multi-color products with RGB, RGBA and RGBW options. LedEngin's brightest White LEDs are capable of emitting 2,000 lumens.

LedEngin's robust emitters are at the core of its unique line of modules and replacement lamps producing unmatched beam quality resulting in true Lux on Target™ for a wide variety of spot and narrow flood directional lighting applications.

LedEngin is committed to providing products that conserve natural resources and reduce greenhouse emissions.

LedEngin reserves the right to make changes to improve performance without notice.

Please contact [Sales@ledengin.com](mailto:Sales@ledengin.com) or (408) 492-0620 for more information.