

GD402SD

**SURFACE MOUNT, SCHOTTKY BARRIER DIODE
 VOLTAGE 30V, CURRENT 0.3A**

Description

The GD402SD is high frequency rectification for switching power supply.

Package Dimensions

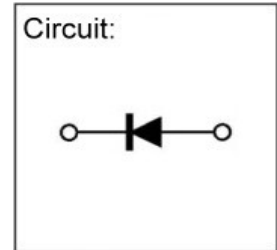
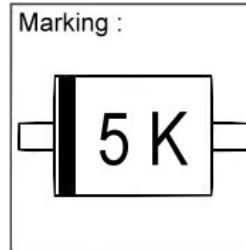
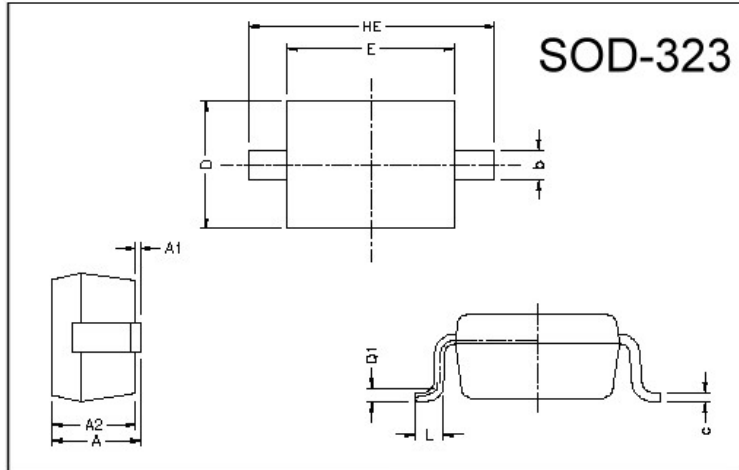

REF.	Millimeter		REF.	Millimeter	
	Min.	Max.		Min.	Max.
A	0.85	1.05			
A1	0	0.10	L	0.20	0.40
A2	0.80	1.00	b	0.25	0.40
D	1.15	1.45	c	0.10	0.18
E	1.60	1.80			
HE	2.30	2.70	Q1	0.15 BSC.	

Absolute Maximum Ratings at TA = 25°C

Parameter	Symbol	Ratings	Unit
Junction Temperature	T _j	+125	°C
Storage Temperature	T _{stg}	-55 ~ +125	°C
Maximum Recurrent Peak Reverse Voltage	V _{RRM}	30	V
Maximum RMS Voltage	V _{RMS}	21	V
Maximum DC Blocking Voltage	V _{DC}	30	V
Peak Forward Surge Current at 8.3mSec single half sine-wave	I _{FSM}	3.0	A
Typical Junction Capacitance between Terminal (Note 1)	C _J	40	pF
Maximum Average Forward Rectified Current	I _o	0.3	A
Total Power Dissipation	PD	225	mW

Electrical Characteristics (at TA = 25°C unless otherwise noted)

Parameter	Symbol	Min.	Typ.	Max.	Unit	Test Conditions
Reverse Breakdown Voltage	V _{(BR)R}	30	-	-	V	I _R =100μA
Maximum Instantaneous Forward Voltage	V _F	-	-	500	mV	I _F =300mA
Maximum Average Reverse Current	I _R	-	-	50	μA	VR1=10V
		-	-	100	μA	VR2=30V

Notes: 1. Measured at 1.0 MHz and 0 reverse bias voltage.

2. ESD sensitive product handling required.

Characteristics Curve

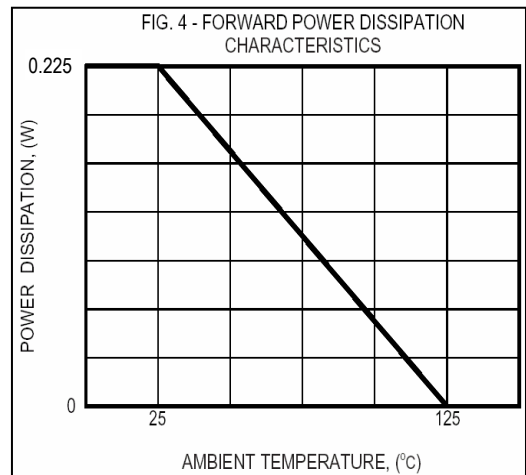
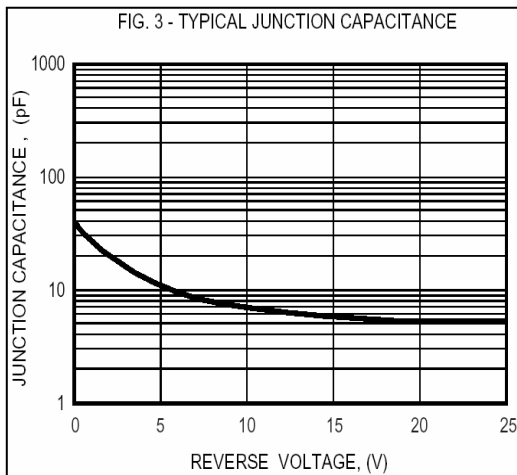
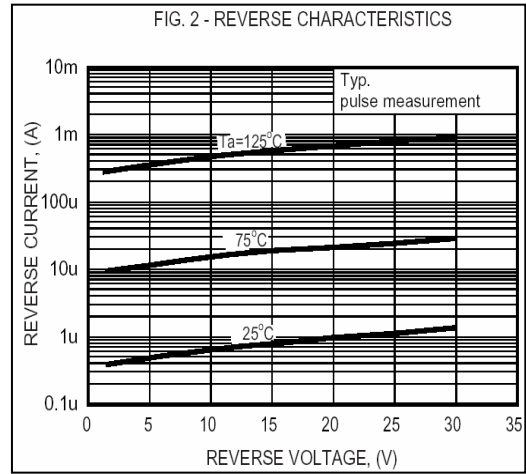
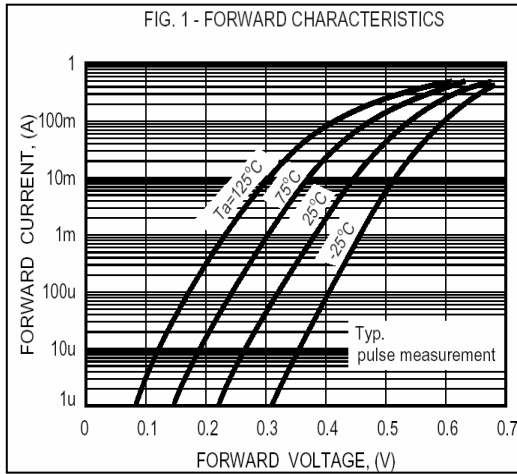

Important Notice:

- All rights are reserved. Reproduction in whole or in part is prohibited without the prior written approval of GTM.
- GTM reserves the right to make changes to its products without notice.
- GTM semiconductor products are not warranted to be suitable for use in life-support Applications, or systems.
- GTM assumes no liability for any consequence of customer product design, infringement of patents, or application assistance.

Head Office And Factory:

- **Taiwan:** No. 17-1 Tatung Rd. Fu Kou Hsin-Chu Industrial Park, Hsin-Chu, Taiwan, R. O. C.
- TEL : 886-3-597-7061 FAX : 886-3-597-9220, 597-0785
- **China:** (201203) No.255, Jang-Jiang Tsai-Lueng RD. , Pu-Dung-Hsin District, Shang-Hai City, China
- TEL : 86-21-5895-7671 ~ 4 FAX : 86-21-38950165