

COMMERCIAL GRADE 8.0 x 3.8 x 2.5mm LOW FREQUENCY SMD CRYSTAL

AKC25M

Pb in High Temperature Solder
(exempt per RoHS 2002/95/EC Annex (7))

RoHS
Compliant



FEATURES:

- Low frequency 32.768kHz
- 2.5mm height ideal for high density circuit boards
- Suitable for RoHS reflow profile
- Extended temperature -40°C to +85°C

APPLICATIONS:

- Wide range in communication & measuring equipment
- Commercial applications
- Wireless communications
- PDA and Palm Pilots

STANDARD SPECIFICATIONS:

PARAMETERS	
ABRACON P/N	AKC25M Series
Nominal Frequency	32.768 kHz
Operating Temperature	-40°C to + 85°C
Turn-over Temperature	+25°C to ±5°C
Storage Temperature	-55°C to +125°C
Frequency Tolerance	±20 ppm max.
Capacitance Ratio	450 typ.
Frequency Coefficient (β)	- 0.034±0.006 ppm/T ²
Equivalent Series Resistance	50 kohms max.
Load Capacitance CL	12.5 pF (see option)
Shunt Capacitance C0	1.35 pF typ.
Drive Level	1.0 μ W max.
Aging @ 25°C ± 3°C first year	± 3 ppm max.
Insulation Resistance	500 M Ω with 100 Vdc ±15V

OPTIONS AND PART IDENTIFICATION:

(Left blank if standard)

AKC25M - 32.768kHz - - -

Load Capacitance
Blank: 12.5pF
9: 9pF
7: 7pF

Freq. Tolerance
Blank: ± 20 ppm
1: ± 10 ppm
5: ± 15 ppm
3: ± 25 ppm
4: ± 30 ppm

Packaging
Blank: Bulk
T: Tape & Reel

COMMERCIAL GRADE 8.0 x 3.8 x 2.5mm LOW FREQUENCY SMD CRYSTAL

AKC25M

AKC25M

Pb in High Temperature Solder
(exempt per RoHS 2002/95/EC Annex (7))

RoHS
Compliant



8.0 x 3.8 x 2.5mm

OUTLINE DRAWING:

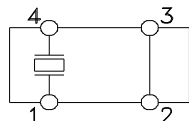
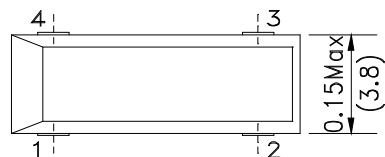

Electrode Arrangement

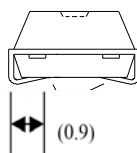
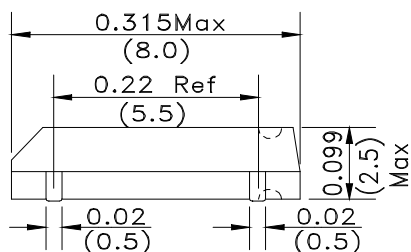

Recommended Land Pattern

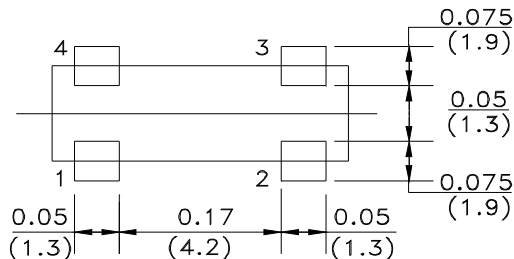

Dimensions: (inches) mm

TAPE & REEL: T = Tape and reel 3,000pcs/reel

REFLOW PROFILE

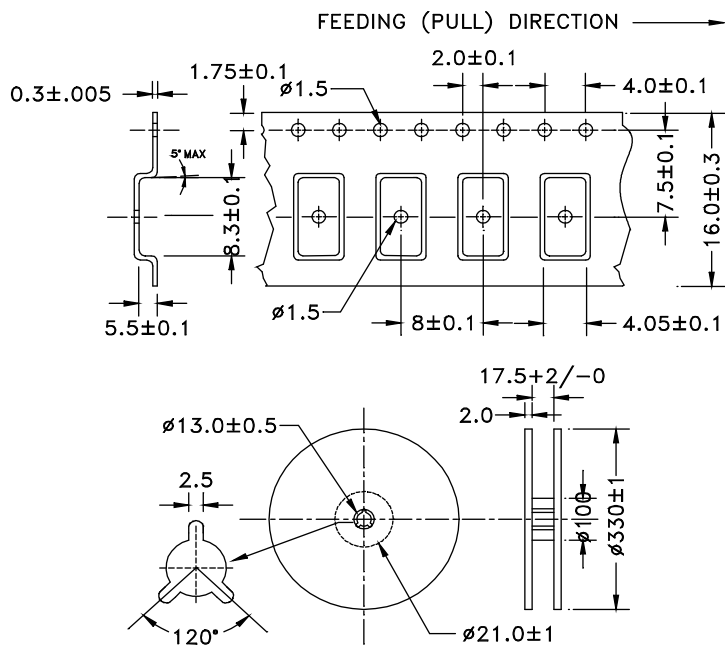

Dimensions: mm

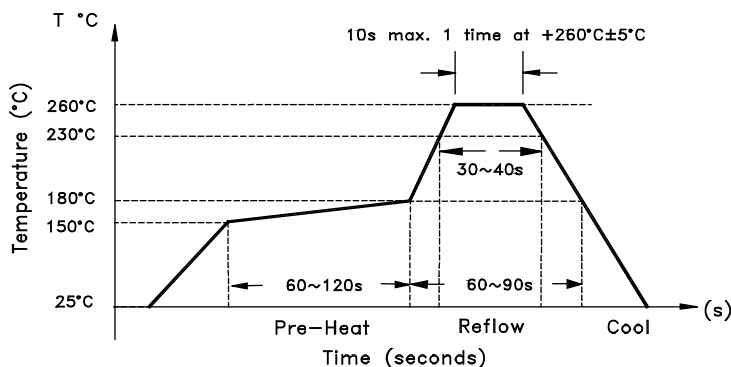

ATTENTION: Abracon Corporation's products are COTS – Commercial-Off-The-Shelf products; suitable for Commercial, Industrial and, where designated, Automotive Applications. Abracon's products are not specifically designed for Military, Aviation, Aerospace, Life-dependant Medical applications or any application requiring high reliability where component failure could result in loss of life and/or property. For applications requiring high reliability and/or presenting an extreme operating environment, written consent and authorization from Abracon Corporation is required. Please contact Abracon Corporation for more information.

ABRACON IS
ISO9001:2008
CERTIFIED



ABRACON
CORPORATION

Visit www.abracon.com for Terms & Conditions of Sale **Revised: 07.19.10**
30332 Esperanza, Rancho Santa Margarita, California 92688
tel 949-546-8000 | fax 949-546-8001 | www.abracon.com