



# LTP- 537/587 SERIES 3784/3785

## 0.5" & 0.54" ALPHANUMERIC DISPLAYS

LITE-ON INC

31E D 5536367 0002458 1 LTN

T-41-35

### FEATURES

- LOW POWER REQUIREMENTS.
- EXCELLENT CHARACTER APPEARANCE.
- HIGH CONTRAST.
- HIGH BRIGHTNESS.
- WIDE VIEWING ANGLE.
- SOLID STATE RELIABILITY.
- COMMON ANODE OR COMMON CATHODE MODELS.
- CATEGORIZED FOR LUMINOUS INTENSITY.
- EASY MOUNTING ON P.C. BOARD.

### DESCRIPTION

The LTP-537/587 series are 0.5 inch (12.7mm) height 16-segment single digit alphanumeric displays.

The red, bright red, green and orange displays have black face and white segment colors. The high efficiency red display has red face and red segment colors.

The LTP-3784/3785 series are 0.54 inch (13.8mm) height 14-segment dual digit alphanumeric displays.

The dual digit displays have gray face and white segment color.

The red series devices utilize LED chips which are made from GaAsP on a GaAs substrate. The bright red and green series devices utilize LED chips which are made from GaP on a transparent GaP substrate. The yellow, orange and high efficiency red series devices utilize LED chips which are made from GaAsP on a transparent GaP substrate.

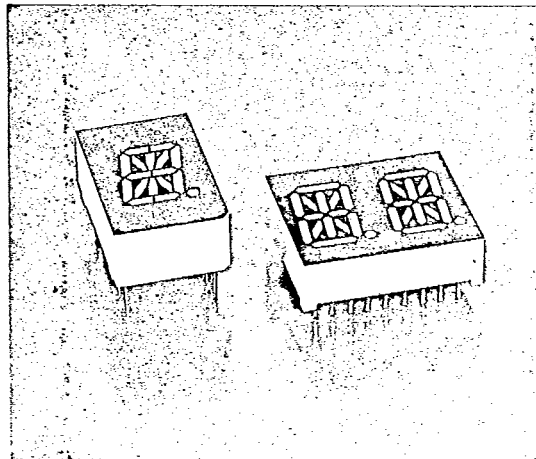

### DEVICES

PART NO. LTP-						DESCRIPTION	PACKAGE DIMENSION	INTERNAL CIRCUIT DIAGRAM
RED	BRIGHT RED	GREEN	YELLOW	ORANGE	HI.-EFF. RED			
537R	537P	537G	537Y	537E	537HR	Common Cathode, Rt. Hand Decimal	A	A
587R	587P	587G	587Y	587E	587HR	Common Anode, Rt. Hand Decimal	A	B
3784R	-	3784G	-	3784E	-	Multiplex Common Cathode, Rt. Hand Decimal	B	C
3785R	-	3785G	-	3785E	-	Multiplex Common Cathode, Rt. Hand Decimal	B	D

5-156

819

PACKAGE DIMENSIONS

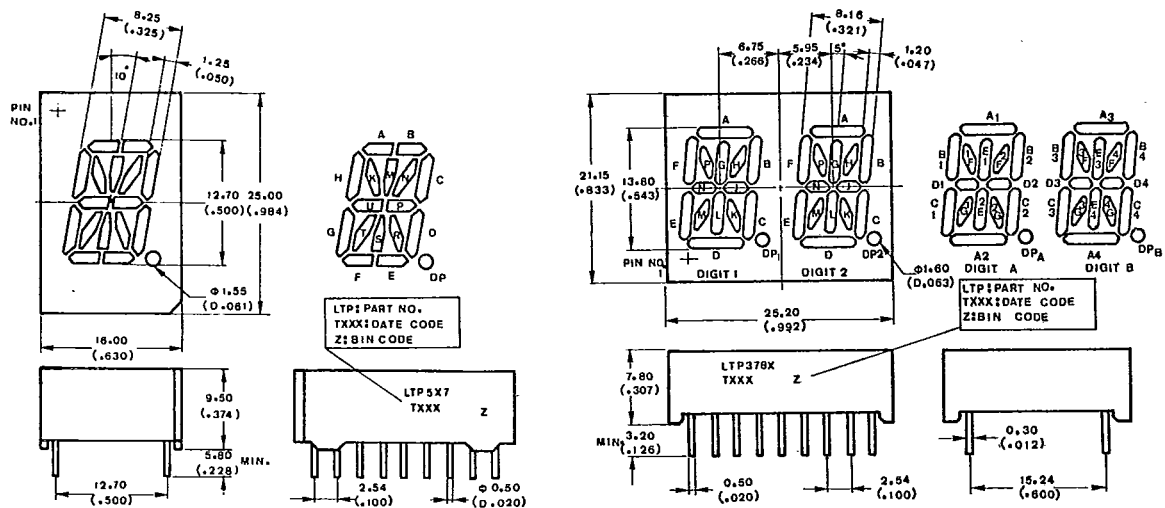

NOTE: All dimensions are in millimeters (inches) tolerance are:

- Lead length (from seating plane): minimum value  $\frac{+1.00}{-0.000}$  mm ( $\frac{+0.040''}{-0.000''}$ )
  - $\pm 0.25$  mm (0.010'')
- unless otherwise noted.

PIN CONNECTION

PIN NO.	CONNECTION			
	A. LTP-537	B. LTP-587	C. LTP-3784	D. LTP-3785
1	Anode B	Cathode B	Anode E	Anode D <sub>1</sub> , D <sub>2</sub> , D <sub>3</sub> , D <sub>4</sub>
2	Anode A	Cathode A	Anode M	No connection
3	Anode M	Cathode M	No Connection	Anode G <sub>1</sub> , G <sub>2</sub> , G <sub>3</sub> , G <sub>4</sub>
4	Anode K	Cathode K	Anode L	Anode C <sub>1</sub> , C <sub>2</sub> , C <sub>3</sub> , C <sub>4</sub>
5	Anode H	Cathode H	Anode K	Cathode A <sub>2</sub> , B <sub>2</sub> , C <sub>2</sub> , E <sub>2</sub> , F <sub>2</sub> , G <sub>2</sub> , D.P.A.
6	Anode G	Cathode G	Anode J	Anode D.P.A.
7	Anode T	Cathode T	Anode D	No Connection
8	Anode F	Cathode F	Anode D.P	Cathode A <sub>3</sub> , B <sub>3</sub> , C <sub>3</sub> , D <sub>3</sub> , E <sub>3</sub> , F <sub>3</sub> , G <sub>3</sub>
9	Anode E	Cathode E	Anode C	Anode D.P.B.
10	Anode D.P.	Cathode D.P.	Anode B	Cathode A <sub>4</sub> , B <sub>4</sub> , C <sub>4</sub> , D <sub>4</sub> , E <sub>4</sub> , F <sub>4</sub> , G <sub>4</sub> , D.P.B.
11	Anode S	Cathode S	Common Cathode, Character 2	No Connection
12	Anode R	Cathode R	Anode A	Anode A <sub>1</sub> , A <sub>2</sub> , A <sub>3</sub> , A <sub>4</sub>
13	Anode D	Cathode D	Anode N	No Connection
14	Anode U	Cathode U	Anode H	Anode B <sub>1</sub> , B <sub>2</sub> , B <sub>3</sub> , B <sub>4</sub>
15	Anode P	Cathode P	Anode G	Cathode A <sub>1</sub> , B <sub>1</sub> , C <sub>1</sub> , D <sub>1</sub> , E <sub>1</sub> , F <sub>1</sub> , G <sub>1</sub>
16	Anode C	Cathode C	Common Cathode, Character 1	No Connection
17	Anode N	Cathode N	Anode P	Anode E <sub>1</sub> , E <sub>2</sub> , E <sub>3</sub> , E <sub>4</sub>
18	Common Cathode	Common Anode	Anode F	Anode F <sub>1</sub> , F <sub>2</sub> , F <sub>3</sub> , F <sub>4</sub>

INTERNAL CIRCUIT DIAGRAM

A. LTP-537

B. LTP-587

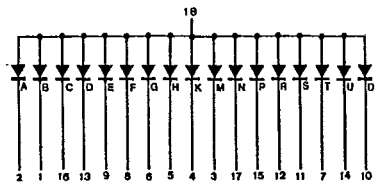
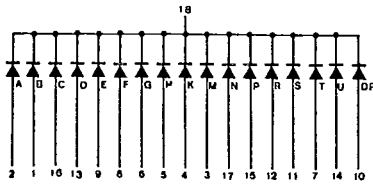

C. LTP-3784

D. LTP-3785

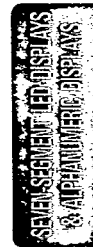
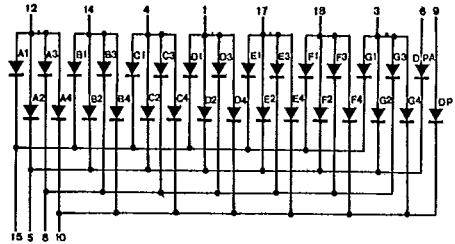
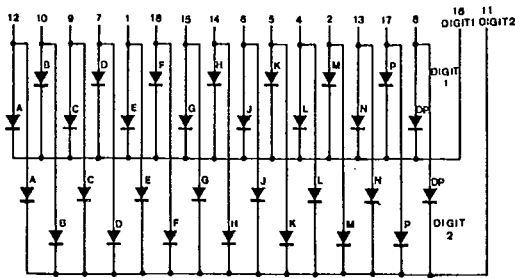

ABSOLUTE MAXIMUM RATINGS AT  $T_A = 25^\circ C$

PARAMETER	RED	BRIGHT RED	GREEN	YELLOW	ORANGE	HI-EFF. RED	UNIT
Power Dissipation Per Segment	55	40	75	60	75	75	mW
Peak Forward Current Per Segment (1/10 Duty Cycle, 0.1ms Pulse Width)	160	60	100	80	100	100	mA
Continuous Forward Current Per Segment	25	15	25	20	25	25	mA
Derating Linear From $25^\circ C$ Per Segment	0.3	0.18	0.3	0.24	0.3	0.3	mA/ $^\circ C$
Reverse Voltage Per Segment	5	5	5	5	5	5	V
Operating Temperature Range	- $25^\circ C$ to + $85^\circ C$						
Storage Temperature Range	- $25^\circ C$ to + $85^\circ C$						
Solder Temperature 1/16 inch Below Seating Plane for 3 Seconds at $260^\circ C$							

**ELECTRICAL/OPTICAL CHARACTERISTICS AT  $T_A = 25^\circ\text{C}$**   
**LTP-537R/587R & LTP-3784R/3785R**

PARAMETER	LTP-	SYMBOL	MIN.	TYP.	MAX.	UNIT	TEST CONDITION
Average Luminous Intensity	537R/587R	$I_v$	200	500		$\mu\text{cd}$	$I_F = 10\text{ mA}$
	3784R/3785R	$I_v$	200	400		$\mu\text{cd}$	$I_F = 10\text{ mA}$
Peak Emission Wavelength		$\lambda_p$		655		nm	$I_F = 20\text{ mA}$
Spectral Line Half-Width		$\Delta\lambda$		24		nm	$I_F = 20\text{ mA}$
Forward Voltage, any Segment or D.P.		$V_F$		1.7	2.0	V	$I_F = 20\text{ mA}$
Reverse Current, any Segment or D.P.		$I_R$			100	$\mu\text{A}$	$V_R = 5\text{ V}$
Luminous Intensity Matching Ratio		$I_v\text{-m}$			2:1		$I_F = 20\text{ mA}$

**TYPICAL ELECTRICAL/OPTICAL CHARACTERISTIC CURVES**

( $25^\circ\text{C}$  Ambient Temperature Unless Otherwise Noted)

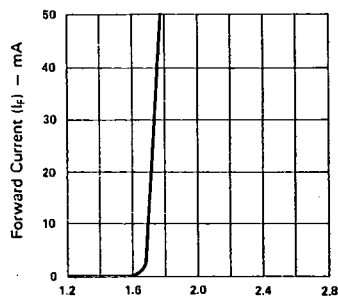

Fig. 1 FORWARD CURRENT Vs. FORWARD VOLTAGE.

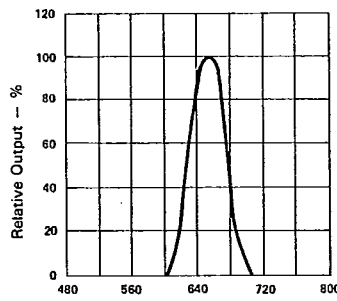

Fig. 2 SPECTRAL RESPONSE.

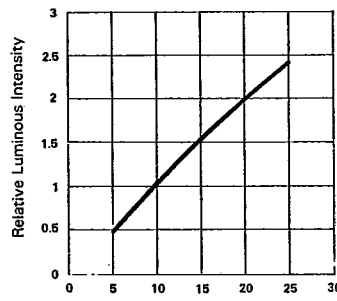

Fig. 3 RELATIVE LUMINOUS INTENSITY Vs. FORWARD CURRENT (PER SEGMENT).

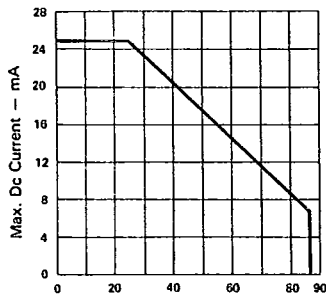

Fig. 4 MAX. ALLOWABLE DC CURRENT PER SEG. Vs AMBIENT TEMPERATURE.

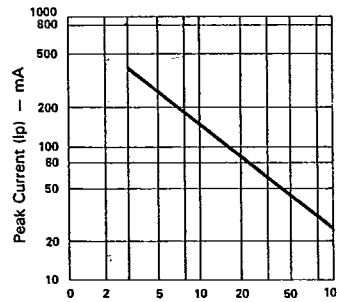

Fig. 5 MAX. PEAK CURRENT Vs. DUTY CYCLE.% (REFRESH RATE - F = 1 KHz)

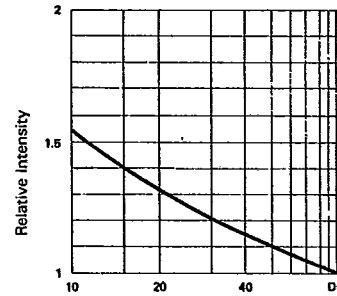

Fig. 6 LUMINOUS INTENSITY Vs. DUTY CYCLE% (AVERAGE  $I_F = 10\text{mA}$  PER SEG.)

ELECTRICAL/OPTICAL CHARACTERISTICS AT  $T_A = 25^\circ\text{C}$   
LTP-537P/587P

PARAMETER	SYMBOL	MIN.	TYP.	MAX.	UNIT	TEST CONDITION
Average Luminous Intensity	$I_V$	300	750		$\mu\text{cd}$	$I_F = 10 \text{ mA}$
Peak Emission Wavelength	$\lambda_p$		697		nm	$I_F = 20 \text{ mA}$
Spectral Line Half-Width	$\Delta\lambda$		90		nm	$I_F = 20 \text{ mA}$
Forward Voltage, any Segment or D.P.	$V_F$		2.1	2.8	V	$I_F = 20 \text{ mA}$
Reverse Current, any Segment or D.P.	$I_R$			100	$\mu\text{A}$	$V_R = 5 \text{ V}$
Luminous Intensity Matching Ratio	$I_V\text{-m}$			2:1		$I_F = 20 \text{ mA}$



TYPICAL ELECTRICAL/OPTICAL CHARACTERISTIC CURVES

( $25^\circ\text{C}$  Ambient Temperature Unless Otherwise Noted)

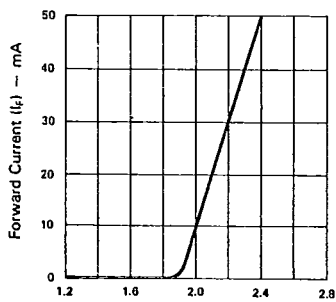

Fig. 1 FORWARD CURRENT Vs. FORWARD VOLTAGE.

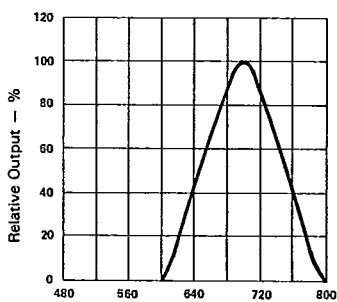

Fig. 2 SPECTRAL RESPONSE.

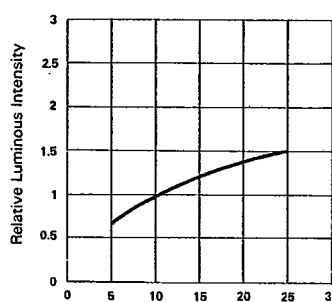

Fig. 3 RELATIVE, LUMINOUS INTENSITY Vs. FORWARD CURRENT (PER SEGMENT).

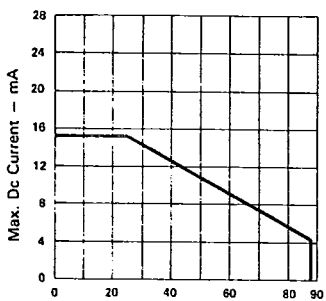

Fig. 4 MAX. ALLOWABLE DC CURRENT PER SEG. Vs AMBIENT TEMPERATURE.

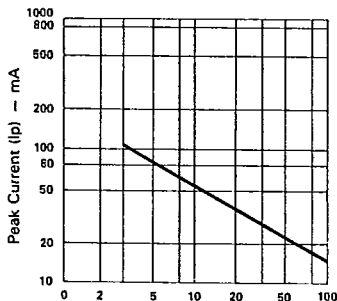

Fig. 5 MAX. PEAK CURRENT Vs. DUTY CYCLE.% (REFRESH RATE -  $F = 1 \text{ KHz}$ )

**ELECTRICAL/OPTICAL CHARACTERISTICS AT TA = 25°C**  
**LTP-537G/587G & LTP-3784G/3785G**

PARAMETER	LTP--	SYMBOL	MIN.	TYP.	MAX.	UNIT	TEST CONDITION
Average Luminous Intensity	537G/587G	Iv	750	2000		μcd	IF = 10 mA
	3784G/3785G	Iv	600	1800		μcd	IF = 10 mA
Peak Emission Wavelength		λp		565		nm	IF = 20 mA
Spectral Line Half-Width		Δλ		30		nm	IF = 20 mA
Forward Voltage, any Segment or D.P.		VF		2.1	2.8	V	IF = 20 mA
Reverse Current, any Segment or D.P.		IR			100	μA	VR = 5 V
Luminous Intensity Matching Ratio		Iv-m			2:1		IF = 20 mA

**TYPICAL ELECTRICAL/OPTICAL CHARACTERISTIC CURVES**  
 (25°C Ambient Temperature Unless Otherwise Noted)

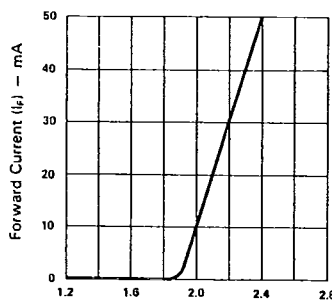

Fig. 1 FORWARD CURRENT Vs. FORWARD VOLTAGE.

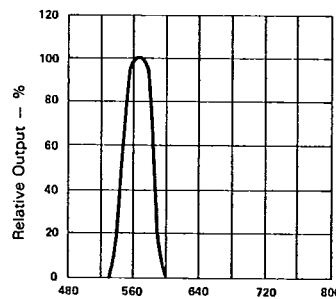

Fig. 2 SPECTRAL RESPONSE.

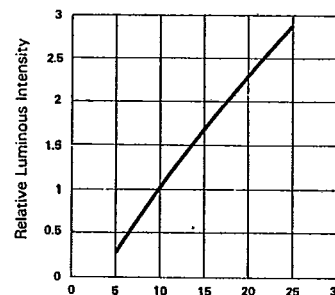
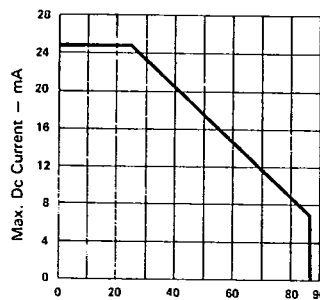

Fig. 3 RELATIVE LUMINOUS INTENSITY Vs. FORWARD CURRENT (PER SEGMENT).



5-161 Fig. 4 MAX. ALLOWABLE DC CURRENT PER SEG. Vs AMBIENT TEMPERATURE.

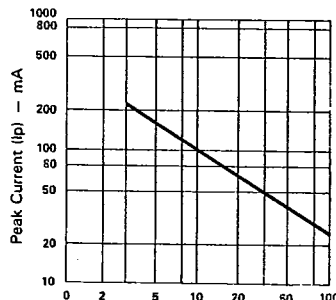

Fig. 5 MAX. PEAK CURRENT Vs. DUTY CYCLE.% (REFRESH RATE - F = 1 KHz)

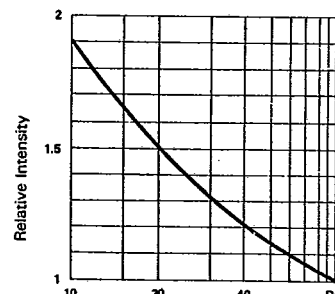

Fig. 6 LUMINOUS INTENSITY Vs. DUTY CYCLE% (AVERAGE If = 10mA PER SEG.)

**ELECTRICAL/OPTICAL CHARACTERISTICS AT TA = 25°C**  
**LTP-537Y/587Y**

PARAMETER	SYMBOL	MIN.	TYP.	MAX.	UNIT	TEST CONDITION
Average Luminous Intensity	$I_v$	750	2000		$\mu\text{cd}$	$I_F = 10 \text{ mA}$
Peak Emission Wavelength	$\lambda_p$		585		nm	$I_F = 20 \text{ mA}$
Spectral Line Half-Width	$\Delta\lambda$		35		nm	$I_F = 20 \text{ mA}$
Forward Voltage, any Segment or D.P.	$V_F$		2.1	2.8	V	$I_F = 20 \text{ mA}$
Reverse Current, any Segment	$I_R$			100	$\mu\text{A}$	$V_R = 5 \text{ V}$
Luminous Intensity Matching Ratio	$I_v\text{-m}$			2:1		$I_F = 20 \text{ mA}$

SEVEN SEGMENT LED DISPLAYS & ALPHANUMERIC DISPLAYS

**TYPICAL ELECTRICAL/OPTICAL CHARACTERISTIC CURVES**

(25°C Ambient Temperature Unless Otherwise Noted)

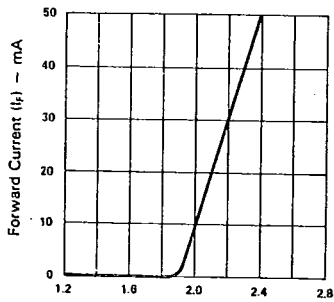

Fig. 1 FORWARD CURRENT Vs. FORWARD VOLTAGE.

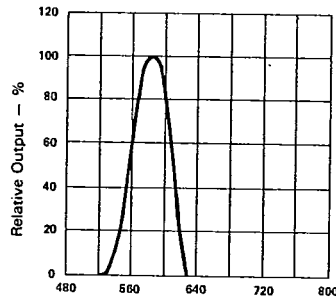

Fig. 2 SPECTRAL RESPONSE.

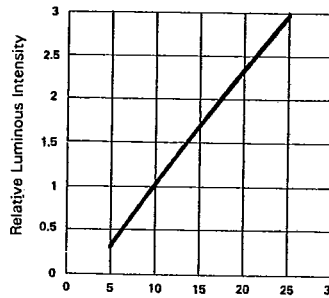

Fig. 3 RELATIVE, LUMINOUS INTENSITY Vs. FORWARD CURRENT (PER SEGMENT).

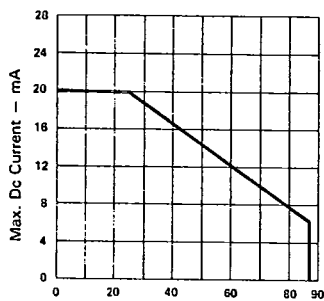

Fig. 4 MAX. ALLOWABLE DC CURRENT PER SEG. Vs AMBIENT TEMPERATURE.

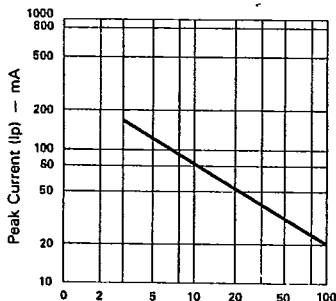

Fig. 5 MAX. PEAK CURRENT Vs. DUTY CYCLE.% (REFRESH RATE - F = 1 KHz)

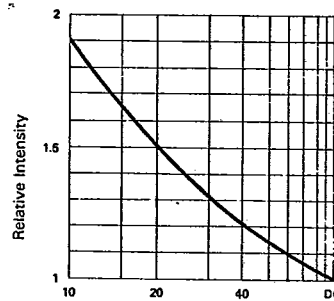

Fig. 6 LUMINOUS INTENSITY Vs. DUTY CYCLE% (AVERAGE  $I_f = 10\text{mA}$  PER SEG.)

**ELECTRICAL/OPTICAL CHARACTERISTICS AT TA = 25°C**  
**LTP-537E/587E & LTP-3784E/3785E**

PARAMETER	LTP-	SYMBOL	MIN.	TYP.	MAX.	UNIT	TEST CONDITION
Average Luminous Intensity	537E/587E	Iv	750	2000		μcd	IF = 10 mA
	3784E/3785E	Iv	600	1800		μcd	IF = 10 mA
Peak Emission Wavelength		λp		630		nm	IF = 20 mA
Spectral Line Half-Width		Δλ		40		nm	IF = 20 mA
Forward Voltage, any Segment or D.P.		VF		2.1	2.8	V	IF = 20 mA
Reverse Current, any Segment or D.P.		IR			100	μA	VR = 5 V
Luminous Intensity Matching Ratio		Iv-m			2:1		IF = 20 mA

**TYPICAL ELECTRICAL/OPTICAL CHARACTERISTIC CURVES**

(25°C Ambient Temperature Unless Otherwise Noted)

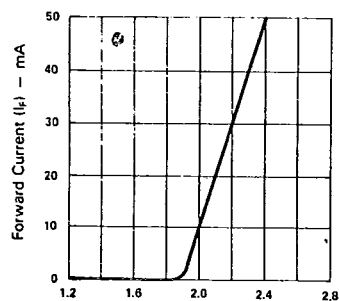

Fig. 1 FORWARD CURRENT Vs. FORWARD VOLTAGE.

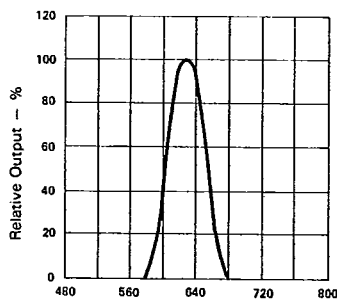

Fig. 2 SPECTRAL RESPONSE.

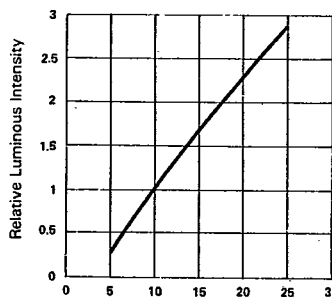

Fig. 3 RELATIVE LUMINOUS INTENSITY Vs. FORWARD CURRENT (PER SEGMENT).

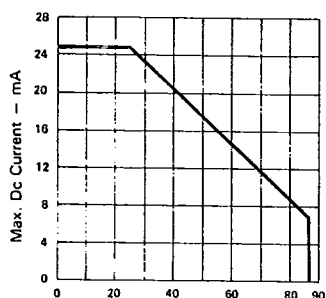

Fig. 4 MAX. ALLOWABLE DC CURRENT PER SEG. Vs AMBIENT TEMPERATURE.

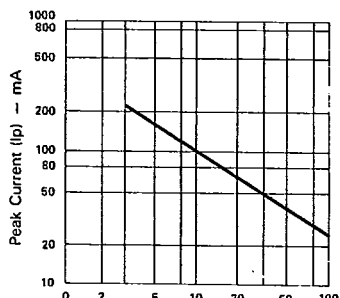

Fig. 5 MAX. PEAK CURRENT Vs. DUTY CYCLE.% (REFRESH RATE - F = 1 KHz)

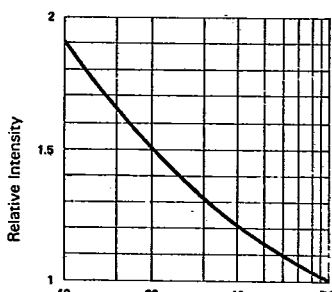
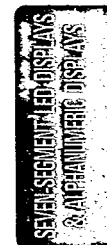

Fig 6 LUMINOUS INTENSITY Vs. DUTY CYCLE% (AVERAGE If = 10mA PER SEG.)



**ELECTRICAL/OPTICAL CHARACTERISTICS AT TA = 25°C**  
**LTP-537HR/587HR**

PARAMETER	SYMBOL	MIN.	TYP.	MAX.	UNIT	TEST CONDITION
Average Luminous Intensity	$I_v$	750	2000		$\mu\text{cd}$	$I_F = 10 \text{ mA}$
Peak Emission Wavelength	$\lambda_p$		635		nm	$I_F = 20 \text{ mA}$
Spectral Line Half-Width	$\Delta\lambda$		40		nm	$I_F = 20 \text{ mA}$
Forward Voltage, any Segment or D.P.	$V_F$		2.1	2.8	V	$I_F = 20 \text{ mA}$
Reverse Current, any Segment or D.P.	$I_R$			100	$\mu\text{A}$	$V_R = 5 \text{ V}$
Luminous Intensity Matching Ratio	$I_v\text{-m}$			2:1		$I_F = 20 \text{ mA}$



**TYPICAL ELECTRICAL/OPTICAL CHARACTERISTIC CURVES**

(25°C Ambient Temperature Unless Otherwise Noted)

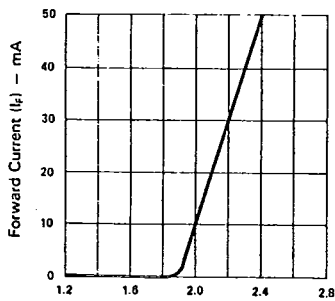

Fig. 1 FORWARD CURRENT Vs. FORWARD VOLTAGE.

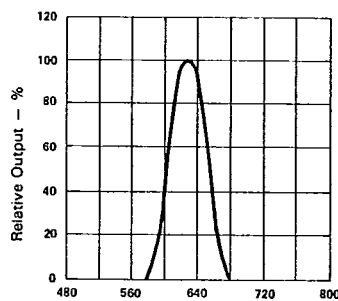

Fig. 2 SPECTRAL RESPONSE.

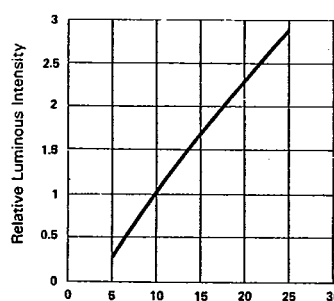

Fig. 3 RELATIVE LUMINOUS INTENSITY Vs. FORWARD CURRENT (PER SEGMENT).

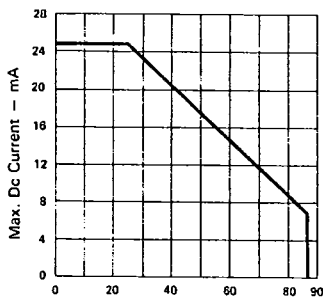

Fig. 4 MAX. ALLOWABLE DC CURRENT PER SEG. Vs AMBIENT TEMPERATURE.

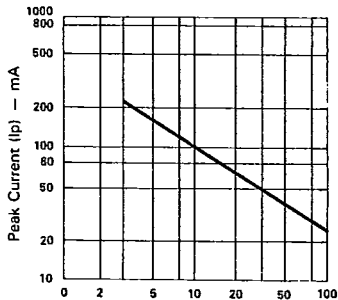

Fig. 5 MAX. PEAK CURRENT Vs. DUTY CYCLE.% (REFRESH RATE - F = 1 KHz)

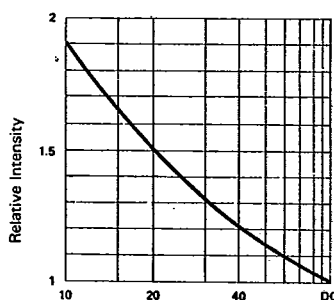

Fig. 6 LUMINOUS INTENSITY Vs. DUTY CYCLE% (AVERAGE  $I_F = 10\text{mA}$  PER SEG.)

**PACKAGING**

T-90-20

## Reel Packaging (Axial Lead Units)

DEVICE TYPE	COMPONENT SPACE (MM) "A"	TAPE SPACE (MM) "B"	REEL DIA (MM) "D"	QUANTITY (EA)		CARTON	
				REEL	CARTON	SIZE (MM)	WEIGHT (KG)
DO-41 DO-41L	5±0.5	52.4±1.5	326~336	5000	20K	355 x 355 x 355	10.5
DO-201AD	10±0.5	52.4±1.5	326~336	1200	4.8K	355 x 355 x 355	9.0
P6(Aleg)	10±0.5	52.4±1.5	326~336	700	2.8K	355 x 355 x 355	8.8

The C dimension of Fig. 3 is between 3.17m.m. and 635mm greater than the length of the component involved.

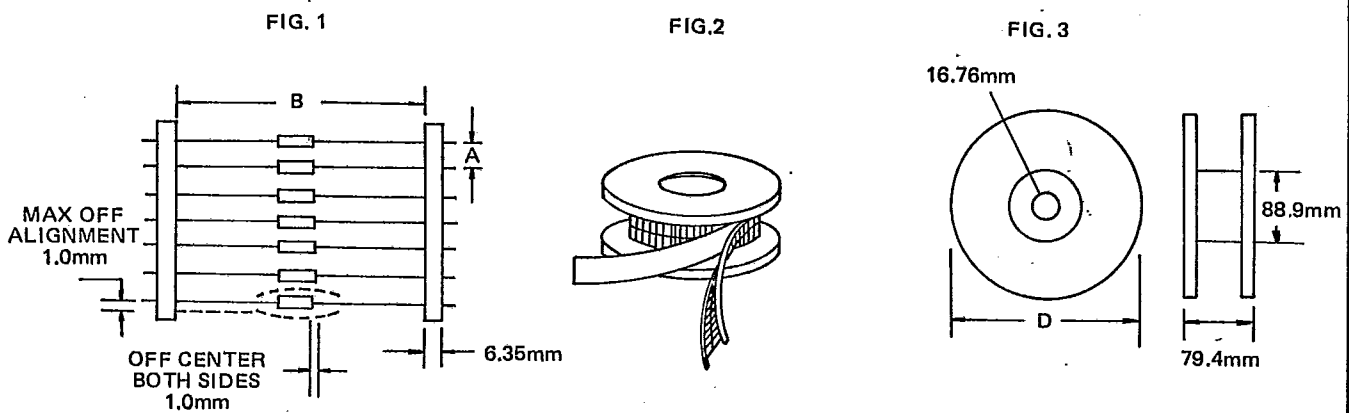

## Bulk Packaging (Axial Lead Devices and Bridge Rectifiers)

DEVICE TYPE	PACKAGING SIZE (MM)		QUANTITY (EA)		APPROX GROSS WEIGHT (KG)	
	BOX	CARTON	BOX	CARTON	BOX	CARTON
DO-41 DO-41L	196 x 84 x 20	450 x 210 x 250	1000	50K	0.38	20
DO-201AD	305 x 93 x 59	355 x 355 x 355	1000	20K	1.35	28
P6(Aleg)	305 x 93 x 59	355 x 355 x 355	500	10K	1.2	24.5
PBM	357 x 125 x 60	530 x 360 x 340	1000	20K	1.5	32.3
PBDF	495 x 155 x 145	500 x 325 x 305	5000	20K	5.1	21.5
PBP	357 x 125 x 60	530 x 360 x 340	500	10K	1.5	31.5
PBL	375 x 220 x 155	470 x 385 x 455	1000	5K	5.7	30.5
PBPC-6	357 x 125 x 60	560 x 360 x 340	250	5K	1.1	22
PBPC-8	357 x 125 x 60	560 x 360 x 340	250	5K	1.7	35
KBPC	375 x 220 x 365	470 x 390 x 385	500	1K	15.1	31.5
KBPC-W	375 x 220 x 365	470 x 390 x 385	500	1K	14.5	30.0

**AMMO BOX PACKAGING**

**BOX SIZE**

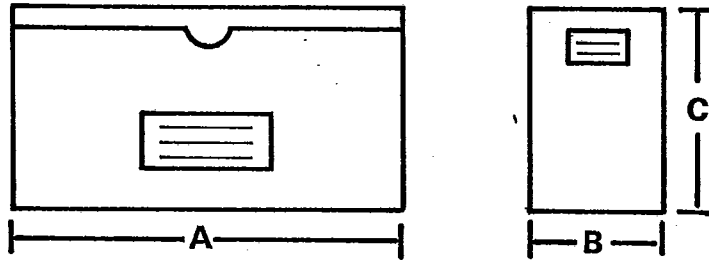

Unit:m. m.

Packaging	Products Outline	Dimension *A*	Dimension *B*	Dimension *C*	Q'ty per BOX
26MM Horizontal Ammo Pack	DO-41 DO-41L(0.6mm Lead)	255	50	95	3K
					3K
52MM Horizontal Ammo Pack	DO-41and DO-41L DO 201AD	250	75	92	3K
					0.8K

**CARTON SIZE**

Unit:m. m.

Packaging	Products Outline	length	Width	High	Q'ty Per Carton
26MM Horizontal Ammo Pack	DO-41 DO-41L(0.6mm Lead)	330	310	268	42K
					48K
52MM Horizontal Ammo Pack	DO-41and DO-41L DO 201AD	355	355	340	12K

# PREFORMED LEAD DRAWING

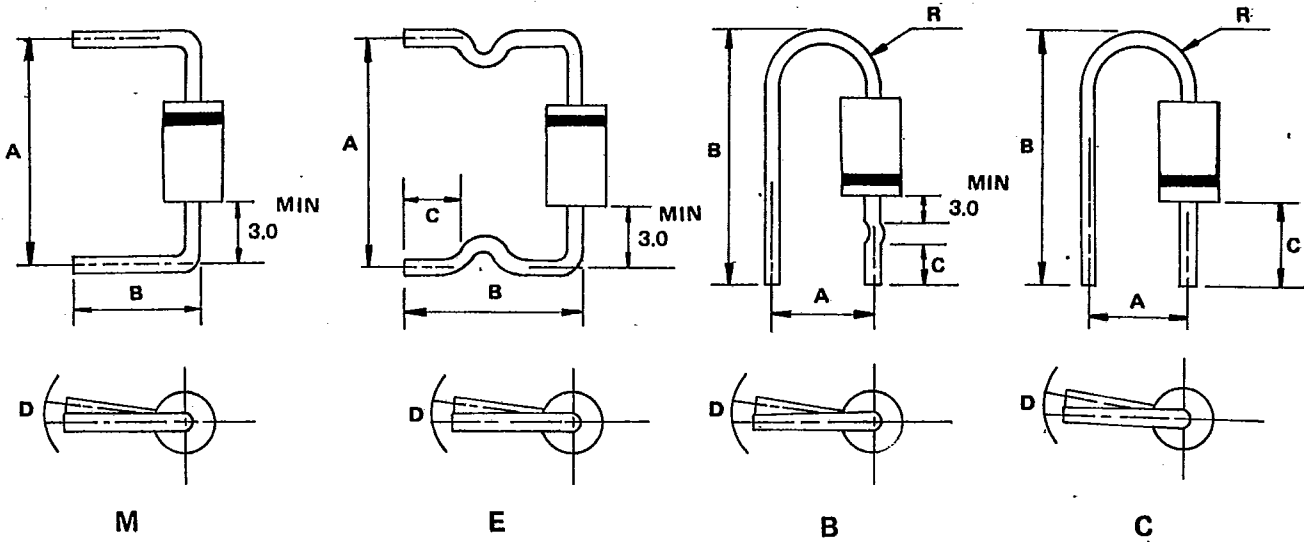

Case type	Preformed type	A (mm)		B (mm)		C (mm)		D (mm)		R (mm)	
		range	tolerance	range	tolerance	range	tolerance	range	tolerance	range	tolerance
D041	M	9.0-20.0	1.0	8.0-22.0	±0.5	-	-	1.5	max	-	-
	E	11.0-20.0	±1.0	11.0-16.0	±1.0	4.0-5.0	±0.5	1.5	max	-	-
	B	7.5	±0.5	19.0-22.0	±0.5	7.5	±0.5	1.5	max	2.5-4.0	Typ
	C	4.5	±0.8	18.0-19.0	±0.5	9.0	±0.5	1.5	max	2.5-4.0	Typ
D0201AD	M	15.0-20.0	±1.0	8.0-22.0	±1.0	-	-	2.0	max	-	-
	E	15.0-20.0	±1.0	10.0-22.0	±1.0	3.0-15.0	±0.5	2.0	max	-	-
P6(Aleg)	M	15.0-20.0	±1.0	8.0-22.0	±1.0	-	-	2.0	max	-	-