

## Transient Suppression Devices

There are two major categories of transient suppressors: a) those that attenuate transients, thus preventing their propagation into the sensitive circuit; and b) those that divert transients away from sensitive loads and so limit the residual voltages.

Attenuating a transient, that is, keeping it from propagating away from its source or keeping it from impinging on a sensitive load is accomplished with filters inserted in series within a circuit. The filter, generally of the low-pass type, attenuates the transient (high frequency) and allows the signal or power flow (low-frequency) to continue undisturbed.

Diverting a transient can be accomplished with a voltage-clamping type device or with a “crowbar” type device. The designs of these two types, as well as their operation and application, are different enough to warrant a brief discussion of each in general terms. A more detailed description will follow later in this section.

A voltage-clamping device is a component having a variable impedance depending on the current flowing through the device or on the voltage across its terminal. These devices exhibit a nonlinear impedance characteristic that is, Ohm’s law is applicable but the equation has a variable R. The variation of the impedance is monotonic; in other words, it does not contain discontinuities in contrast to the crowbar device, which exhibits a turn-on action. The volt-ampere characteristic of these clamping devices is somewhat time-dependent, but they do not involve a time delay as do the sparkover of a gap or the triggering of a thyristor.

With a voltage-clamping device, the circuit is essentially unaffected by the presence of the device before and after the transient for any steady-state voltage below the clamping level. The voltage clamping action results from the increased current drawn through the device as the voltage tends to rise. If this current increase is greater than the voltage rise, the impedance of the device is nonlinear (Figure 1). The apparent “clamping” of the voltage results from the increased voltage drop (IR) in the source impedance due to the increased current. It should be clearly understood that the device depends on the source impedance to produce the clamping. One is seeing a voltage divider action at work, where the ratio of the divider is not constant but changes. However, if the source impedance is very low, then the ratio is low. The suppressor cannot be effective with zero source impedance (Figure 2) and works best when the voltage divider action can be implemented.

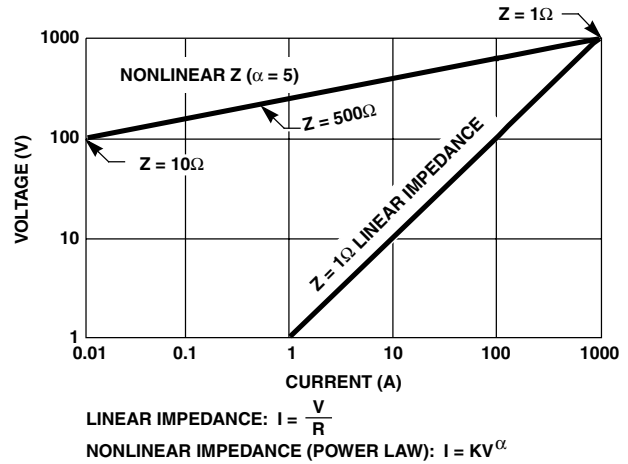

FIGURE 1. VOLTAGE/CURRENT CHARACTERISTIC FOR A LINEAR 1Ω RESISTOR AND NONLINEAR

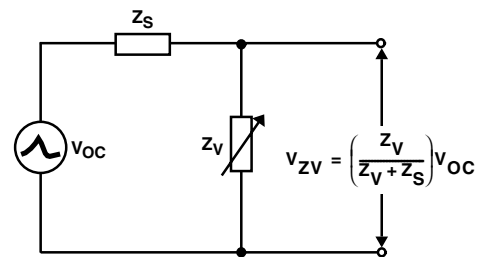

FIGURE 2A. VOLTAGE CLAMPING DEVICE

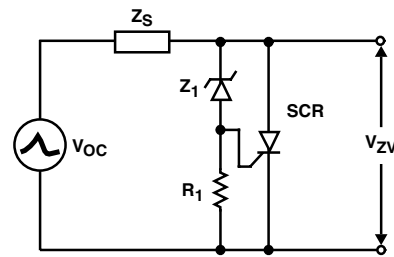

FIGURE 2B. CROWBAR DEVICE

FIGURE 2. DIVISION OF VOLTAGE WITH VARIABLE IMPEDANCE SUPPRESSOR

Crowbar-type devices involve a switching action, either the breakdown of a gas between electrodes or the turn-on of a thyristor, for example. After switching on, they offer a very low impedance path which diverts the transient away from the parallel-connected load.

These types of crowbar devices can have two limitations. One is delay time, which could leave the load unprotected during the initial transient rise. The second is that a power current from the voltage source will follow the surge discharge (called “follow-current” or “power-follow”). In AC circuits, this power-follow current may not be cleared at a natural current zero unless the device is designed to do so; in DC circuits the clearing is even more uncertain. In some cases, additional means must be provided to “open” the crowbar.

**Filters**

The frequency components of a transient are several orders of magnitude above the power frequency of an AC circuit and, of course, a DC circuit. Therefore, an obvious solution is to install a low-pass filter between the source of transients and the sensitive load.

The simplest form of filter is a capacitor placed across the line. The impedance of the capacitor forms a voltage divider with the source impedance, resulting in attenuation of the transient at high frequencies. This simple approach may have undesirable side effects, such as a) unwanted resonances with inductive components located elsewhere in the circuit leading to high peak voltages; b) high inrush currents during switching, or, c) excessive reactive load on the power system voltage. These undesirable effects can be reduced by adding a series resistor hence, the very popular use of RC snubbers and suppression networks. However, the price of the added resistance is less effective clamping.

Beyond the simple RC network, conventional filters comprising inductances and capacitors are widely used for interference protection. As a bonus, they also offer an effective transient protection, provided that the filter's front-end components can withstand the high voltage associated with the transient.

There is a fundamental limitation in the use of capacitors and filters for transient protection when the source of transients is unknown. The capacitor response is indeed nonlinear with frequency, but it is still a linear function of current.

To design a protection scheme against random transients, it is often necessary to make an assumption about the characteristics of the impinging transient. If an error in the source impedance or in the open-circuit voltage is made in that assumption, the consequences for a linear suppressor and a nonlinear suppressor are dramatically different as demonstrated by the following comparison.

**A Simplified Comparison Between Protection with Linear and Nonlinear Suppressor Devices**

Assume an open-circuit voltage of 3000V (see Figure 2):

1. If the source impedance is  $Z_S = 50\Omega$   
With a suppressor impedance of  $Z_V = 8\Omega$   
The expected current is:

$$I = \frac{3000}{50 + 8} = 51.7A \text{ and } V_R = 8 \times 51.7 = 414V$$

The maximum voltage appearing across the terminals of a typical nonlinear V130LA20A varistor at 51.7A is 330V.

Note that:

$$\begin{aligned} Z_S \times I &= 50 \times 51.7 = 2586V \\ Z_V \times I &= 8 \times 51.7 = \frac{414V}{= 3000V} \end{aligned}$$

2. If the source impedance is only  $5\Omega$  (a 10:1 error in the assumption), the voltage across the same linear  $8\Omega$  suppressor is:

$$V_R = 3000 \frac{8}{5 + 8} = 1850V$$

However, the nonlinear varistor has a much lower impedance; again, by iteration from the characteristic curve, try 400V at 500A, which is correct for the V130LA20A; to prove the correctness of our “educated guess” we calculate I,

$$I = \frac{3000 - 400V}{5} = 520A \quad \begin{aligned} Z_S \times I &= 5 \times 520 = 2600V \\ V_C &= \frac{400V}{= 3000V} \end{aligned}$$

which justifies the “educated guess” of 500A in the circuit.

**Summary**

TABLE 1. 3000V “OPEN-CIRCUIT” TRANSIENT VOLTAGE

	ASSUMED SOURCE IMPEDANCE	
	50Ω	5Ω
PROTECTIVE DEVICE	PROTECTIVE LEVEL ACHIEVED	
Linear 8Ω	414V	1850V
Nonlinear Varistor	330V	400V

Similar calculations can be made, with similar conclusions, for an assumed error in open-circuit voltage at a fixed source impedance. In that case, the linear device is even more sensitive to an error in the assumption. The calculations are left for the interested reader to work out.

The example calculated in the simplified comparison between protection with linear and nonlinear suppression devices shows that a source impedance change from an assumed  $50\Omega$  to  $5\Omega$  can produce a change of about 414V to 1850V for the protective voltage of a typical linear suppressor. With a typical nonlinear suppressor, the

corresponding change is only 330V to 400V. In other words, a variation of only 21% in the protective level achieved with a nonlinear suppressor occurs for a 10 to 1 error in the assumption made on the transient parameters, in contrast to a 447% variation in the protective level with a linear suppressor for the same error in assumption. Nonlinear voltage-clamping devices give the lowest clamping voltage, resulting in the best protection against transients.

### **Crowbar Devices**

This category of suppressors, primarily gas tubes or carbon-block protectors, is widely used in the communication field where power-follow current is less of a problem than in power circuits. Another form of these suppressors is the hybrid circuit which uses solid-state or MOV devices.

In effect, a crowbar device short-circuits a high voltage to ground. This short will continue until the current is brought to a low level. Because the voltage (arc or forward-drop) during the discharge is held very low, substantial currents can be carried by the suppressor without dissipating a considerable amount of energy within it. This capability is a major advantage.

**Volt-Time Response** - When the voltage rises across a spark gap, no significant conduction can take place until transition to the arc mode has occurred by avalanche breakdown of the gas between the electrodes.

**Power-Follow** - The second characteristic is that a power current from the steady-state voltage source will follow the surge discharge (called "follow-current" or "power-follow").

### **Voltage-Clamping Devices**

To perform the voltage limiting function, voltage-clamping devices at the beginning of the section depend on their nonlinear impedance in conjunction with the transient source impedance. Three types of devices have been used: reverse selenium rectifiers, avalanche (Zener) diodes and varistors made of different materials, i.e., silicon carbide, zinc oxide, etc. [1].

**Selenium Cells** - Selenium transient suppressors apply the technology of selenium rectifiers in conjunction with a special process allowing reverse breakdown current at high-energy levels without damage to the polycrystalline structure. These cells are built by developing the rectifier elements on the surface of a metal plate substrate which gives them good thermal mass and energy dissipation performance. Some of these have self-healing characteristics which allows the device to survive energy discharges in excess of the rated values for a limited number of operations characteristics that are useful, if not "legal" in the unsure world of voltage transients.

The selenium cells, however, do not have the clamping ability of the more modern metal-oxide varistors or avalanche diodes. Consequently, their field of application has been considerably diminished.

**Zener Diodes** - Silicon rectifier technology, designed for transient suppression, has improved the performance of regulator-type Zener diodes. The major advantage of these diodes is their very effective clamping, which comes closest to an ideal constant voltage clamp.

Since the diode maintains the avalanche voltage across a thin junction area during surge discharge, substantial heat is generated in a small volume. The major limitation of this type of device is its energy dissipation capability.

**Silicon Carbide Varistors** - Until the introduction of metal-oxide varistors, the most common type of "varistor" was made from specially processed silicon carbide. This material was very successfully applied in high-power, high-voltage surge arresters. However, the relatively low values of this material produce one of two results. Either the protective level is too high for a device capable of withstanding line voltage or, for a device producing an acceptable protective level, excessive standby current would be drawn at normal voltage if directly connected across the line. Therefore, a series gap is required to block the normal voltage.

In lower voltage electronic circuits, silicon carbide varistors have not been widely used because of the need for using a series gap, which increases the total cost and reproduces some of the characteristics of gaps described earlier. However, this varistor has been used as a current-limiting resistor to assist some gaps in clearing power-follow current.

**Metal-Oxide Varistors** - A varistor functions as a nonlinear variable impedance. The relationship between the current in the device,  $I$ , and the voltage across the terminals,  $V$  is typically described by a power law:  $I = kV^\alpha$ . While more accurate and more complete equations can be derived to reflect the physics of the device, [2, 3] this definition will suffice here. A more detailed discussion will be found in Application Note AN9767, "Littelfuse Varistors - Basic Properties, Terminology and Theory".

The term  $\alpha$  (alpha) in the equation represents the degree of nonlinearity of the conduction. A linear resistance has an  $\alpha = 1$ . The higher the value of  $\alpha$ , the better the clamp, which explains why  $\alpha$  is sometimes used as a figure of merit. Quite naturally, varistor manufacturers are constantly striving for higher alphas.

This family of transient voltage suppressors are made of sintered metal oxides, primarily zinc oxide with suitable additives. These varistors have  $\alpha$  values considerably greater than those of silicon carbide varistors, typically in the range of an effective value of 15 to 30 measured over several decades of surge current.

The high exponent values ( $\alpha$ ) of the metal-oxide varistors have opened completely new fields of applications by providing a sufficiently low protective level and a low standby current. The opportunities for applications extend from low-power electronics to the largest utility-type surge arresters.

**Transient Suppressors Compared**

Because of diversity of characteristics and nonstandardized manufacturer specifications, transient suppressors are not easy to compare. A graph (Figure 3) shows the relative volt-ampere characteristics of the four common devices that are used in 120V AC circuits. A curve for a simple ohmic resistor is included for comparison. It can be seen that as the alpha factor increases, the curve's voltage-current slope becomes less steep and approaches an almost constant voltage. High alphas are desirable for clamping applications that require operation over a wide range of currents.

It also is necessary to know the device energy-absorption and peak-current capabilities when comparisons are made. Table 2 includes other important parameters of commonly used suppressors.

**Standby Power** - The power consumed by the suppressor unit at normal line voltage is an important selection criterion. Peak standby current is one factor that determines the standby power of a suppressor. The standby power dissipation depends also on the alpha characteristic of the device.

As an example, a selenium suppressor in Table 2 can have a 12mA peak standby current and an alpha of 8 (Figure 3). Therefore, it has a standby power dissipation of about 0.5W on a 120V<sub>RMS</sub> line (170V peak). A zener-diode suppressor has standby power dissipation of less than a milliwatt. And a silicon-carbide varistor, in a 0.75" diameter disc, has standby power in the 200mW range. High standby power in the lower alpha devices is necessary to achieve a reasonable clamping voltage at higher currents.

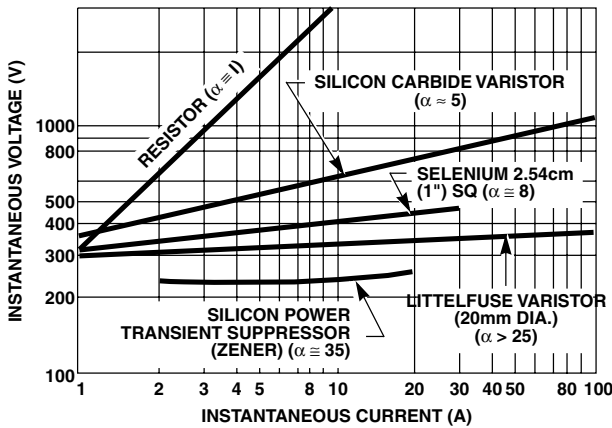

FIGURE 3. V-I CHARACTERISTIC OF FOUR TRANSIENT SUPPRESSOR DEVICE

The amount of standby power that a circuit can tolerate may be the deciding factor in the choice of a suppressor. Though high-alpha devices have low standby power at the nominal design voltage, a small line-voltage rise would cause a

dramatic increase in the standby power. Figure 4 shows that for a zener-diode suppressor, a 10% increase above rated voltage increases the standby power dissipation above its rating by a factor of 30. But for a low-alpha device, such as silicon carbide, the standby power increases by only 1.5 times.

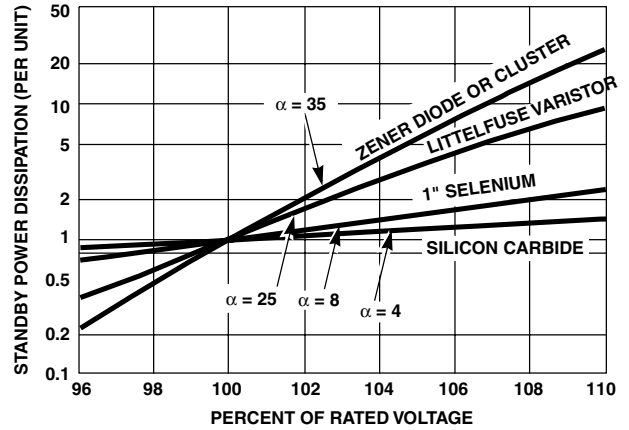

FIGURE 4. CHANGES IN STANDBY POWER ARE CONSIDERABLY GREATER WHEN THE SUPPRESSOR'S ALPHA IS HIGH

Typical volt-time curves of a gas discharge device are shown in Figure 5 indicating an initial high clamping voltage. The gas-discharge suppressor turns on when the transient pulse exceeds the impulse sparkover voltage. Two representative surge rates 1kV/ $\mu$ s and 20kV/ $\mu$ s are shown in Figure 5. When a surge voltage is applied, the device turns on at some point within the indicated limits. At 20kV/ $\mu$ s, the discharge unit will sparkover between 600V and 2500V. At 1kV/ $\mu$ s, it will sparkover between 390V and 1500V.

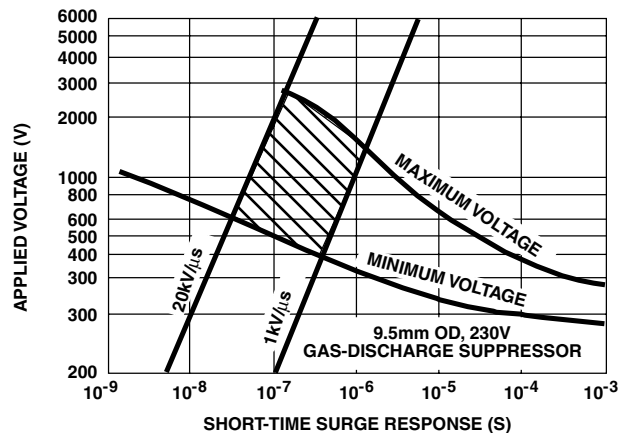

FIGURE 5. IMPULSE BREAKOVER OF A GAS-DISCHARGE DEVICE DEPENDS UPON THE RATE OF VOLTAGE RISE AS WELL AS THE ABSOLUTE VOLTAGE LEVEL

## Application Note 9768

**TABLE 2. CHARACTERISTICS AND FEATURES OF TRANSIENT VOLTAGE SUPPRESSOR TECHNOLOGY**

V-I CHARACTERISTICS	DEVICE TYPE	LEAK-AGE	FOLLOW ON I	CLAMPING VOLTAGE	ENERGY CAPABIL-ITY	CAPACI-TANCE	RE-SPONSE TIME	COST
	Ideal Device	Zero To Low	No	Low	High	Low Or High	Fast	Low
	Zinc Oxide Varistor	Low	No	Moderate To Low	High	Moderate To High	Fast	Low
	Zener	Low	No	Low	Low	Low	Fast	High
	Crowbar (Zener - SCR Combination)	Low	Yes (Latching Holding I)	Low	Medium	Low	Fast	Moderate
	Spark Gap	Zero	Yes	High Ignition Voltage Low Clamp	High	Low	Slow	Low To High
	Triggered Spark Gap	Zero	Yes	Lower Ignition Voltage Low Clamp	High	Low	Moderate	Moderate
	Selenium	Very High	No	Moderate To High	Moderate To High	High	Fast	High
	Silicon Carbide Varistor	High	No	High	High	High	Fast	Low

The gas discharge device may experience follow-current. As the AC voltage passes through zero at the end of every half cycle the arc will extinguish, but if the electrodes are hot and the gas is ionized, it may reignite on the next cycle. Depending on the power source, this current may be sufficient to cause damage to the electrodes. The follow current can be reduced by placing a limiting resistor in series with the device, or, selecting a GDT specifically designed for this application with a high follow-current threshold.

The gas discharge device is useful for high current surges and it is often advantageous to provide another suppression device in a combination that allows the added suppressor to protect against the high initial impulse. Several hybrid combinations with a varistor or avalanche diode are possible.

### Comparison of Zener Diode and Littelfuse Varistor Transient Suppressors

#### Peak Pulse Power

Transient suppressors have to be optimized to absorb large amounts of power or energy in a short time duration: nanoseconds, microseconds, or milliseconds in some instances.

Electrical energy is transformed into heat and has to be distributed instantaneously throughout the device. Transient thermal impedance is much more important than steady state thermal impedance, as it keeps peak junction temperature to a minimum. In other words, heat should be instantly and evenly distributed throughout the device.

The varistor meets these requirements: an extremely reliable device with large overload capability. Zener diodes dissipate electrical energy into heat in the depletion region of the die, resulting in high peak temperature.

Figure 6 shows Peak Pulse Power vs Pulse width for the V8ZA2 and the P6KE 6.8, the same devices compared for leakage current.

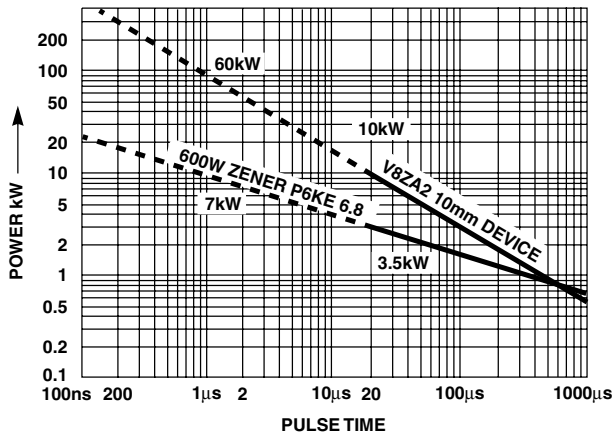

FIGURE 6. PEAK PULSE POWER vs PULSE TIME

At 1ms, the two devices are almost the same. At 2µs the varistor is almost 10 times greater, 7kW for the P6KE 6.8 Zener vs 60kW for the varistor V8ZA2.

#### Clamping Voltage

Clamping voltage is an important feature of a transient suppressor. Zener diode type devices have lower clamping voltages than varistors. Because these protective devices are connected in parallel with the device or system to be protected, a lower clamping voltage can be advantageous in certain applications.

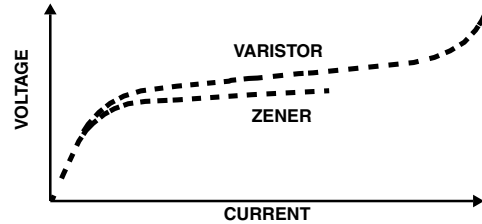

FIGURE 7. CHARACTERISTICS OF ZENER AND VARISTOR

#### Speed of Response

Response times of less than 1ps are sometimes claimed for zener diodes, but these claims are not supported by data in practical applications. For the varistor, measurements were made down to 500ps with a voltage rise time (dv/dt) of 1 million volts per microsecond. These measurements are described in Application Note AN9767. Another consideration is the lead effect. Detailed information on the lead effect can be found further in this section and in Application Note AN9773. In summary, both devices are fast enough to respond to real world transient events.

#### Leakage Current

Leakage current can be an area of misconception when comparing a varistor and zener diode, for example. Figure 8 shows a P6KE 6.8 and a V8ZA2, both recommended by their manufacturers for protection of integrated circuits having 5V supply voltages.

## Application Note 9768

The zener diode leakage is about 100 times higher at 5V than the varistor, 200 $\mu$ A vs less than 2 $\mu$ A, in this example.

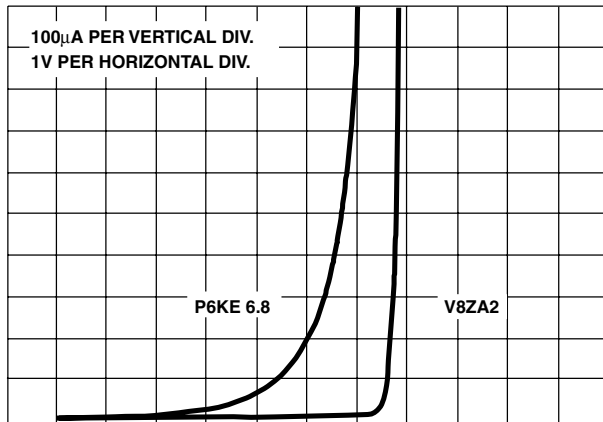

**FIGURE 8. CHARACTERISTIC OF ZENER P6KE 6.8 vs LITTELFUSE VARISTOR V8ZA2**

The leakage current of a zener can be reduced by specifying a higher voltage device.

### “Aging”

It has been stated that a varistor's V-I characteristic changes every time high surge current or energy is subjected to it. That is not the case.

As illustrated in Figure 9, the V-I characteristic initially changed on some of the devices, but returned to within a few percent of its original value after applying a second or third pulse. To be conservative, peak pulse limits have been established on data sheets. In many cases, these limits have been exceeded many fold without harm to the device. This does not mean that established limits should be exceeded, but rather, viewed in perspective of the definition of a failed device. A “failed” varistor device shows a  $\pm 10\%$  change of the V-I characteristic at the 1mA point.

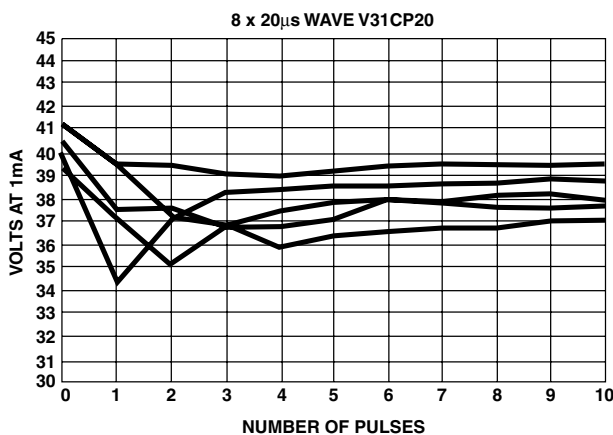

**FIGURE 9. 250A PULSE WITHSTAND CAPABILITIES**

### Failure Mode

Varistors subjected to energy levels beyond specified ratings may be damaged. Varistors fail in the short circuit mode. Subjected to high enough energy, however, they may physically rupture or explode, resulting in an open circuit condition. These types of failures are quite rare for properly selected devices because of the large peak pulse capabilities inherent in varistors.

Zeners can fail either short or open. If the die is connected by a wire, it can act as a fuse, disconnecting the device and resulting in an Open circuit. Designers must analyze which failure mode, open or short, is preferred for their circuits.

When a device fails during a transient, a short is preferred, as it will provide a current path bypassing and will continue to protect the sensitive components. On the other hand, if a device fails open during a transient, the remaining energy ends up in the sensitive components that were supposed to be protected.

Another consideration is a hybrid approach, making use of the best features of both types of transient suppressors (See Figure 10).

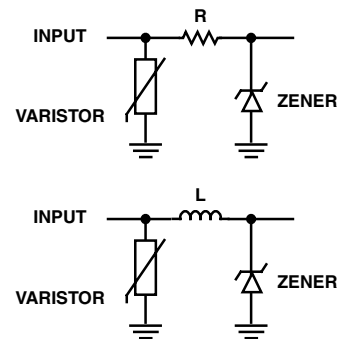

**FIGURE 10. HYBRID PROTECTION USING VARISTORS, ZENERS, R AND L**

### Capacitance

Depending on the application, transient suppressor capacitance can be a very desirable or undesirable feature. Varistors in comparison to zener diodes have a higher capacitance. In DC circuits capacitance is desirable, the larger the better. Decoupling capacitors are used on IC supply voltage pins and can in many cases be replaced by varistors, providing both the decoupling and transient voltage clamping functions.

The same is true for filter connectors where the varistor can perform the dual functions of providing both filtering and transient suppression.

There are circuits however, where capacitance is less desirable, such as high frequency digital or some analog circuits.

## Application Note 9768

---

As a rule the source impedance of the signal and the frequency as well as the capacitance of the transient suppressor should be considered.

The current through  $C_P$  is a function of  $dv/dt$  and the distortion is a function of the signal's source impedance. Each case must be evaluated individually to determine the maximum allowable capacitance.

The structural characteristics of metal-oxide varistors unavoidably result in an appreciable capacitance between the device terminals, depending on area, thickness and material processing. For the majority of power applications, this capacitance can be of benefit. In high-frequency applications, however, the effect must be taken into consideration in the overall system design.

### References

For Littelfuse documents available on the web, see <http://www.littelfuse.com/>

- [1] Sakshaug, E.C., J.S. Kresge and S.A. Miske, "A New Concept in Station Arrester Design," IEEE Trans. PAS-96, No. 2, March-April 1977, pp. 647-656.
- [2] Philipp, H.R. and L.M. Levinson, "Low Temperature Electrical Studies in Metal Oxide Varistors - A Clue to Conduction Mechanisms," Journal of Applied Physics, Vol. 48, April 1977, pp. 1621-1627.
- [3] Philipp, H.R. and L.M. Levinson, "Zinc Oxide for Transient Suppression," IEEE Trans. PHP, December 1977.
- [4] "Surge Arresters for Alternating Current Power Circuits," ANSI Standard C62.1, IEEE Standard 28.
- [5] "Lightning Arresters. Part I: Nonlinear Resistor Type Arresters for AC Systems," IEC Recommendation 99-1, 1970.
- [6] Matsuoka, M., T. Masuyama and Y. Iida, "Supplementary Journal of Japanese Society of Applied Physics," Vol. 39, 1970, pp. 94-101.
- [7] Harnden, J.D., F.D. Martzloff, W.G. Morris and F.B. Golden, "Metal-Oxide Varistor: A New Way to Suppress Transients," Electronics, October 2, 1972.
- [8] Martzloff, F.D., "The Development of a Guide on Surge Voltages in Low - Voltage AC Power Circuits," Report 81CRD047, General Electric, Schenectady, New York, 1981.
- [9] Martzloff, F.D., "Varistor versus Environment: Winning the Rematch," Report 85CRD037, General Electric, Schenectady, New York, May 1985.