

## G5U2178

### CMOS Low Dropout Voltage Regulator

#### Description

The G5U2178 series of positive, linear regulators feature low quiescent current (45µA typ.) with low dropout voltage, making them ideal for battery applications.

Output voltages are set at the factory and trimmed to 1.5% accuracy.

These rugged devices have both Thermal Shutdown, and Current Fold-back to prevent device failure under the "Worst" of operating conditions.

In applications requiring a low noise, regulated supply, place a 1000pF capacitor between Bypass and Ground. The G5U2178 is stable with an output capacitance of 4.7µF or greater.

#### Features

- Very Low Dropout Voltage
- Guaranteed 1.5A output
- Over-Temperature Shutdown
- Current Limiting
- Short Circuit Current Fold-back
- Highly Accurate ± 1.5%
- Low Temperature Coefficient
- Noise Reduction Bypass Capacitor
- Power-Saving Shutdown Mode

#### Applications

- Battery Powered Widgets
- Instrumentation
- Wireless Devices
- PC Peripherals
- Portable Electronics

#### Package Dimensions

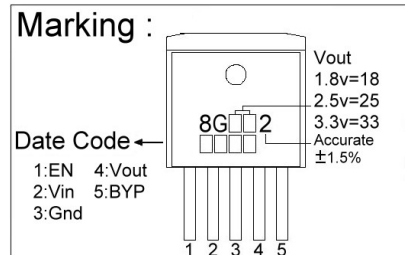
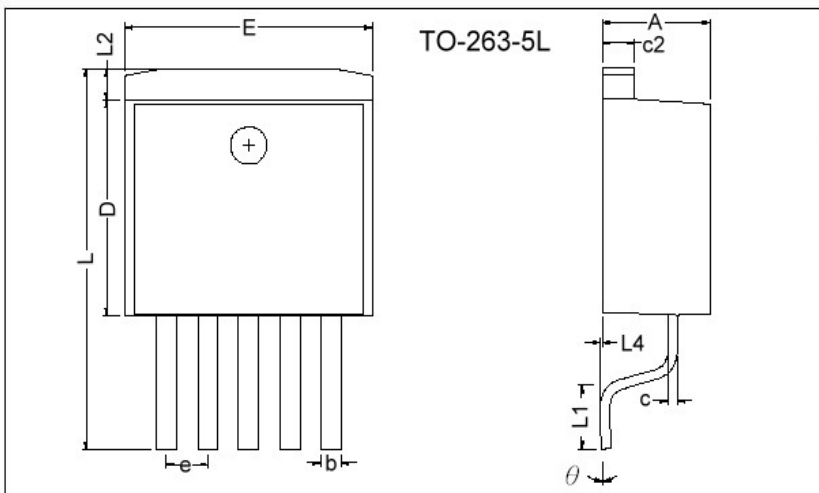

REF.	Millimeter		REF.	Millimeter	
	Min.	Max.		Min.	Max.
A	4.40	4.80	c2	1.25	1.45
b	0.66	0.91	L2	1.27 REF.	
L4	0.00	0.30	D	8.6	9.0
c	0.36	0.5	e	1.70 REF.	
L1	2.29	2.79	L	14.6	15.8
E	9.80	10.4	θ	0°	8°

#### Typical Application Circuit

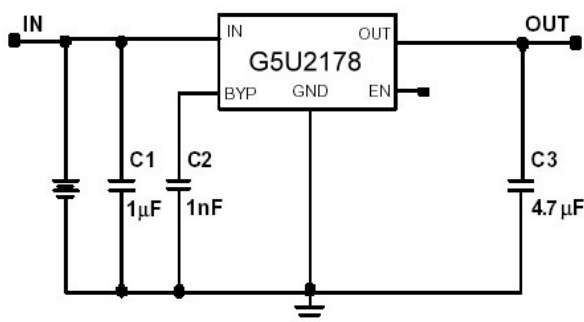

**Absolute Maximum Ratings**

Parameter	Symbol	Ratings	Unit
Input Max Voltage	V <sub>IN</sub>	8	V
Output Current	I <sub>OUT</sub>	PD/(V <sub>IN</sub> -V <sub>O</sub> )	A
Output Voltage	V <sub>OUT</sub>	1.5~5.0	V
Operating Ambient Temperature	T <sub>opr</sub>	-40 ~ +85	°C
Junction Temperature	T <sub>j</sub>	-40 ~ +125	°C
Maximum Junction Temperature	T <sub>j Max</sub>	150	°C
Thermal Resistance	θ <sub>jc</sub>	5	°C/W
Internal Power Dissipation(ΔT=100°C)	PD	3000	mW
EDS Classification		B	

**Electrical Characteristics** V<sub>IN</sub>=V<sub>OUT</sub>(T)+2V, V<sub>EN</sub>=V<sub>IN</sub>, T<sub>A</sub>=25°C unless otherwise noted

Parameter	Symbol	Condition	Min	TYP	Max	Unit	
Output Voltage	V <sub>OUT</sub> (E) (Note1)	V <sub>EN</sub> =V <sub>EH</sub> min, I <sub>O</sub> =1mA	-1.5%	V <sub>OUT</sub> (T) (Note2)	1.5%	V	
Output Current	I <sub>O</sub>	V <sub>OUT</sub> >1.2V	1.5	-	-	A	
Current Limit	I <sub>LIM</sub>	V <sub>OUT</sub> >1.2V	1.5	2.0	-	A	
Load Regulation	REG <sub>LOAD</sub>	I <sub>O</sub> =1mA to 1.5A	-1	0.2	1	%	
Dropout Voltage	V <sub>DROPOUT</sub>	I <sub>O</sub> =1.5A V <sub>O</sub> =V <sub>OUT</sub> (E)-2%	1.5V<V <sub>OUT</sub> (T)≤2.0V	-	-	1300	mV
			2.0V<V <sub>OUT</sub> (T)≤2.8V	-	-	800	
			2.8V<V <sub>OUT</sub> (T)	-	-	600	
Quiescent Current	I <sub>Q</sub>	I <sub>O</sub> =0mA	-	45	70	μA	
Ground Pin Current	I <sub>GN</sub>	I <sub>O</sub> =1mA~1.5A	-	45	-	μA	
Line Regulation	REG <sub>LINE</sub>	I <sub>O</sub> =1mA V <sub>IN</sub> =V <sub>OUT</sub> (T)+1 to V <sub>OUT</sub> (T)+2	V <sub>OUT</sub> (T)<2.0V	-0.15	-	0.15	%
			2.0V≤V <sub>OUT</sub> (T)<4.0V	-0.1	0.02	0.1	
			4.0V≤V <sub>OUT</sub> (T)	-0.4	-	0.4	
Input Voltage	V <sub>IN</sub>		Note3	-	7	V	
Over Temperature Shutdown	OTS		-	150	-	°C	
Over Temperature Hysteresis	OTH		-	30	-	°C	
Output Voltage Temperature Coefficient	TC		-	30	-	ppm/°C	
Short Circuit Current	I <sub>sc</sub>	V <sub>OUT</sub> <0.4V	-	750	-	mA	
Power Supply Rejection	PSRR	I <sub>O</sub> =100mA C <sub>O</sub> =4.7μF ceramic	f=1kHz	-	50	-	dB
			f=10kHz	-	20	-	
Power Supply Rejection	PSRR	I <sub>O</sub> =100mA C <sub>O</sub> =4.7μF ceramic C <sub>BYP</sub> =0.01μF	f=1kHz	-	75	-	dB
			f=10kHz	-	55	-	
Output Voltage Noise	e <sub>N</sub>	f=10Hz~100kHz I <sub>O</sub> =10mA, C <sub>BYP</sub> =0μF				μVrms	
Output Voltage Noise	e <sub>N</sub>	f=10Hz~100kHz I <sub>O</sub> =10mA, C <sub>BYP</sub> =0.01μF				μVrms	
EN Input Threshold	V <sub>EH</sub>		2.0	-	V <sub>IN</sub>	V	
	V <sub>EL</sub>		0	-	0.4	V	
EN Input Bias Current	I <sub>EH</sub>	V <sub>IN</sub> =7V	-	-	0.1	μA	
	I <sub>EL</sub>	V <sub>EN</sub> =0V, V <sub>IN</sub> =7V	-	-	0.5	μA	
Shutdown Supply Current	I <sub>SD</sub>	V <sub>IN</sub> =5V, V <sub>OUT</sub> =0V, V <sub>EN</sub> =0V	-	0.5	2	μA	

Note 1: V<sub>OUT</sub>(E) =Effective Output Voltage (i.e. the output voltage when "V<sub>OUT</sub>(T) + 2.0V" is provided at the V<sub>IN</sub> pin while maintaining a certain I<sub>OUT</sub> value).

2: V<sub>OUT</sub>(T) =Specified Output Voltage

3: V<sub>IN</sub>(MIN) =V<sub>OUT</sub>+V<sub>DROPOUT</sub>

## Ordering Information ( contd. )

Part Number	Marking	Output Voltage	Part Number	Marking	Output Voltage
G5U2178-15	8G152 XXXX	1.5V	G5U2178-18	8G182 XXXX	1.8V
G5U2178-25	8G252 XXXX	2.5V	G5U2178-33	8G332 XXXX	3.3V
G5U2178-47	8G472 XXXX	4.75V	G5U2178-50	8G502 XXXX	5.0V

## Characteristics Curve

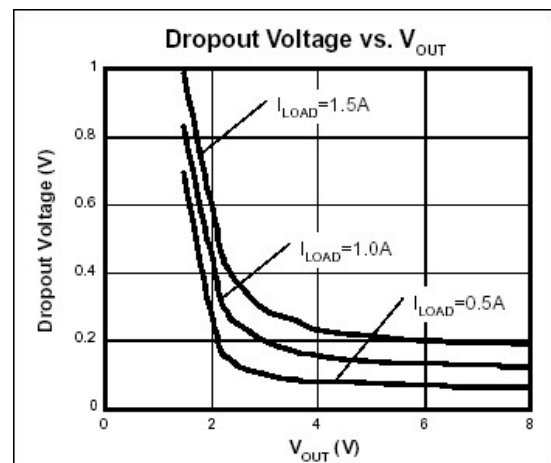
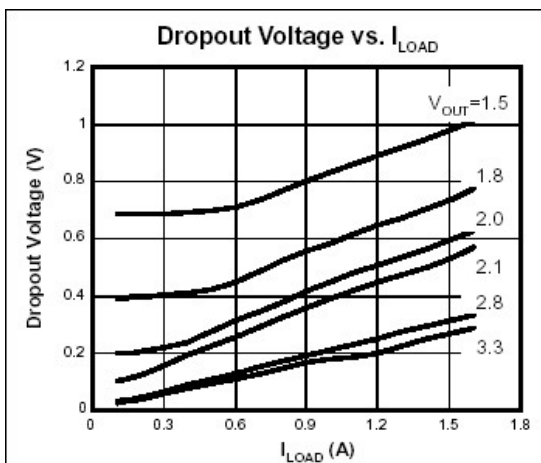
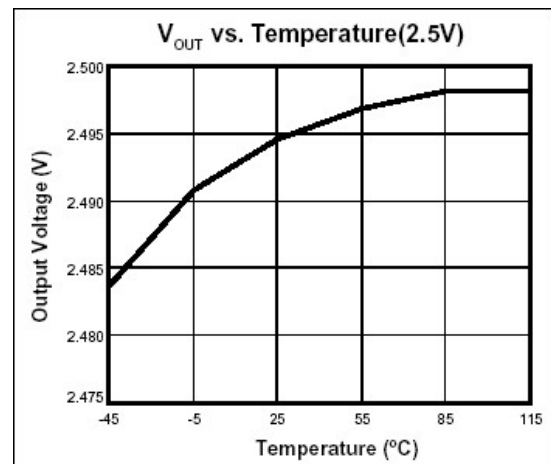
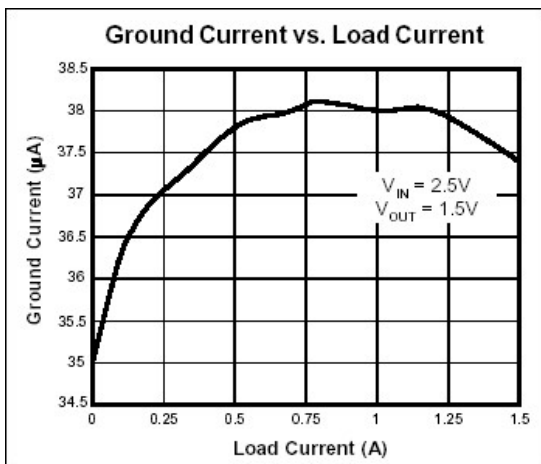
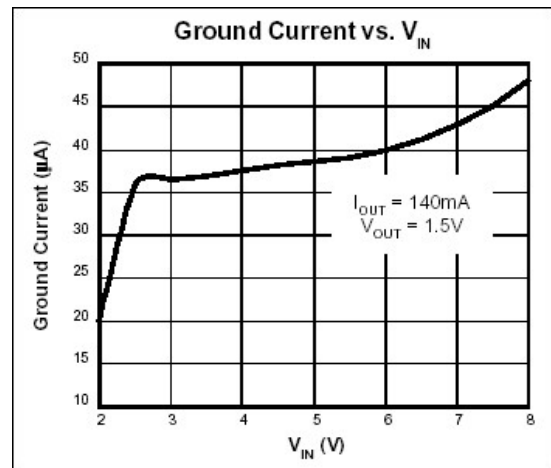
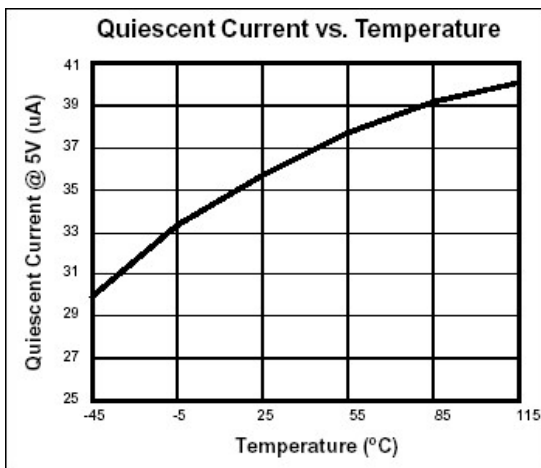

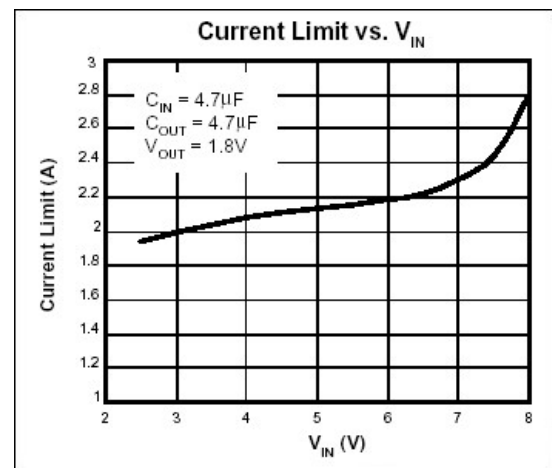
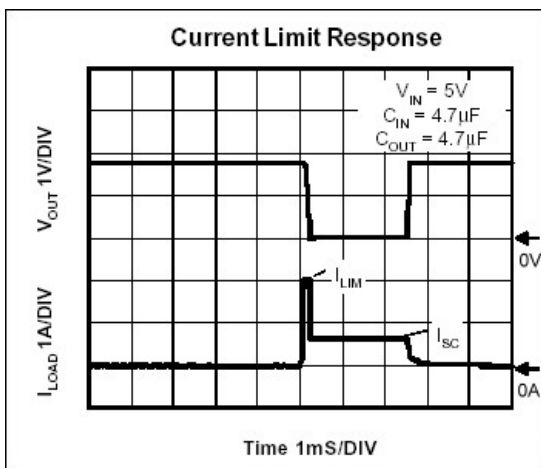
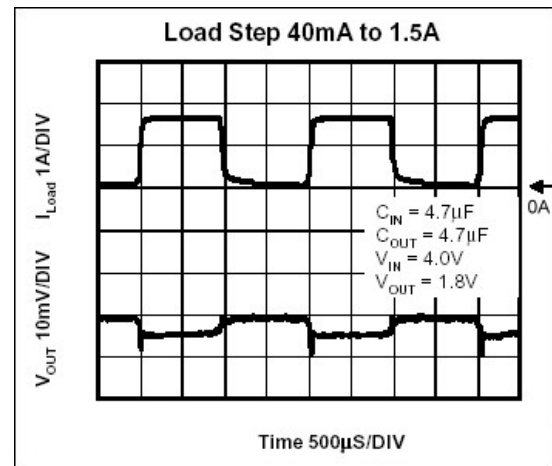
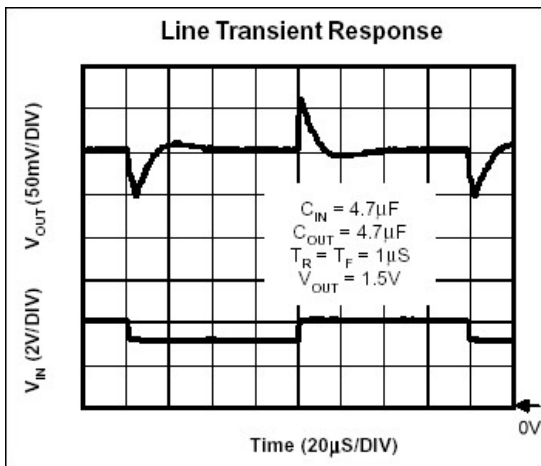
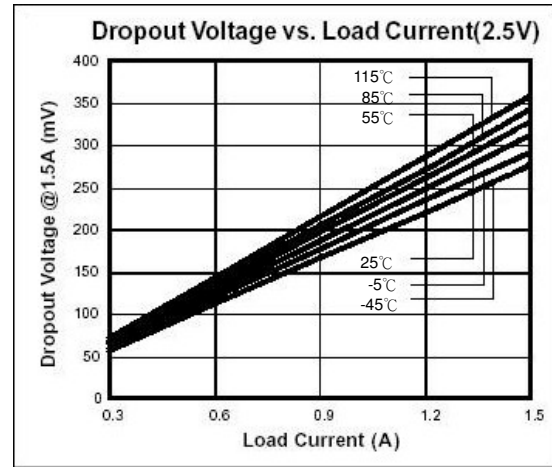
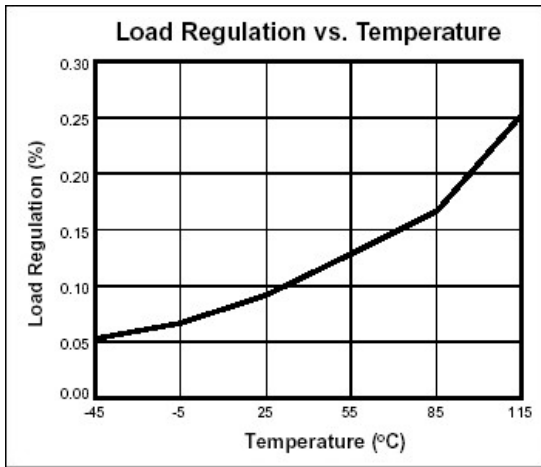

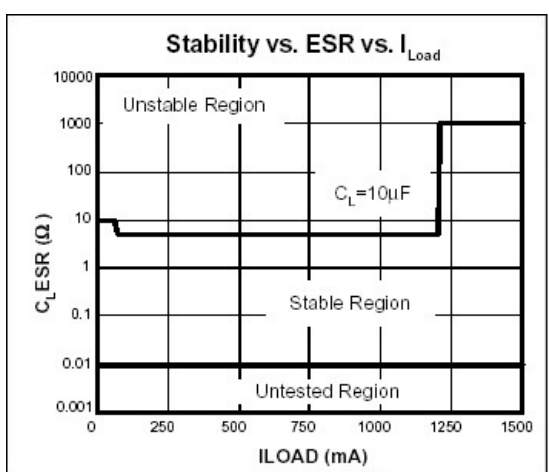
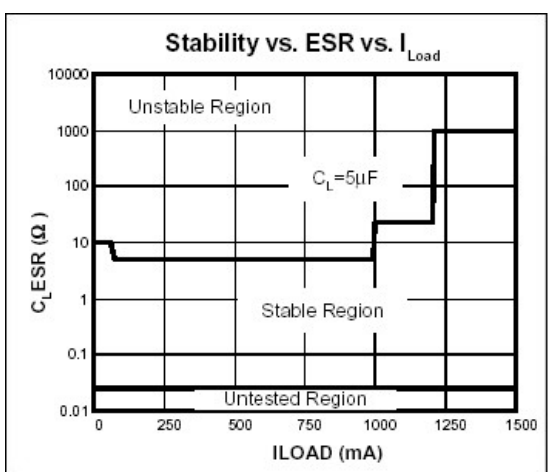
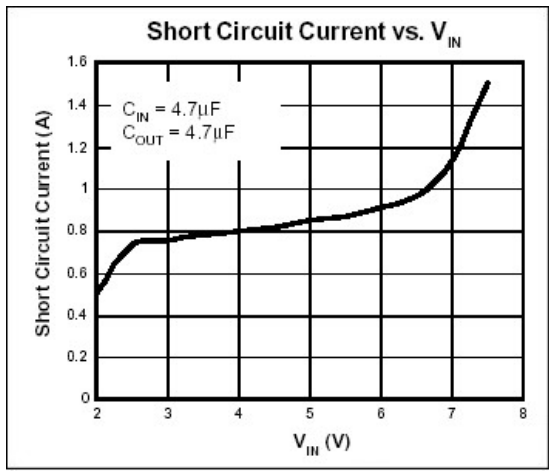
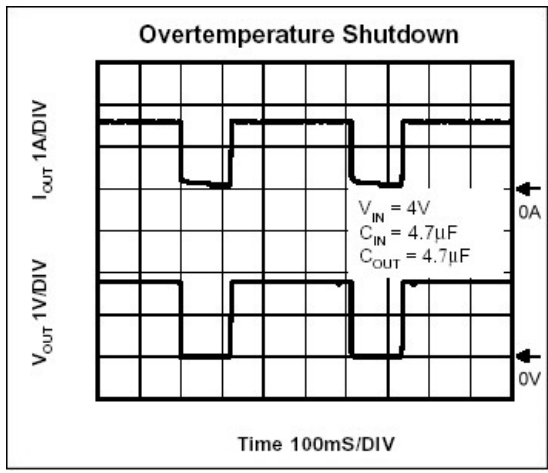

## Detailed Description

The G5U2178 series of COMS regulators contain a PMOS pass transistor, voltage reference, error amplifier, over-current protection, and thermal shutdown.

The P-channel pass transistor receives data from the error amplifier, over-current shutdown, and thermal protection circuits. During normal operation, the error amplifier compares the output voltage to a precision reference. Over-current and Thermal shutdown circuits become active when the junction temperature exceeds 140°C, or the current exceeds 2.2A. During thermal shutdown, the output voltage remains low. Normal operation is restored when the junction temperature drops below 120°C.

The G5U2178 behaves like a current source when the load reaches 2.2A. However, if the load impedance drops below 0.3Ω, the current drops back to 600mA to prevent excessive power dissipation. Normal operation is restored when the load resistance exceeds 0.75Ω.

## External Capacitors

The G5U2178 is stable with an output capacitance to ground of 4.7μF or greater. Ceramic capacitors have the lowest ESR, and will offer the best AC performance. Conversely, Aluminum Electrolytic capacitors exhibit the highest ESR, resulting in the poorest AC response. Unfortunately, large value ceramic capacitors are comparatively expensive. One option is to parallel a 0.1μF ceramic capacitor with a 10μF Aluminum Electrolytic. The benefit is low ESR, high capacitance, and low overall cost.

A second capacitor is recommended between the input and ground to stabilize Vin. The input capacitor should be at least 0.1μF to have a beneficial effect.

A third capacitor can be connected between the BY-PASS pin and GND. This capacitor can be a low cost Polyester Film variety between the value of 0.001~0.01μF. A large capacitor improves the AC ripple rejection, but also makes the output come up slowly. This "Soft" turn-on is desirable in some applications to limit turn-on surges.

All capacitors should be placed in close proximity to the pins. A "Quiet" ground termination is desirable. This can be achieved with a "Star" connection.

## Enable

When pulled low, the PMOS pass transistor shuts off, and all internal circuits are powered down. In this state, the quiescent current is less than 1μA. This pin behaves much like an electronic switch.

100kΩ resistor is necessary between VEN source and EN pin when VEN is higher than VIN.

(Note: there is no internal pull-up for EN PIN)

**Important Notice:**

- All rights are reserved. Reproduction in whole or in part is prohibited without the prior written approval of GTM.
- GTM reserves the right to make changes to its products without notice.
- GTM semiconductor products are not warranted to be suitable for use in life-support Applications, or systems.
- GTM assumes no liability for any consequence of customer product design, infringement of patents, or application assistance.

**Head Office And Factory:**

- **Taiwan:** No. 17-1 Tatung Rd. Fu Kou Hsin-Chu Industrial Park, Hsin-Chu, Taiwan, R. O. C.
- TEL : 886-3-597-7061 FAX : 886-3-597-9220, 597-0785
- **China:** (201203) No.255, Jang-Jiang Tsai-Lueng RD. , Pu-Dung-Hsin District, Shang-Hai City, China
- TEL : 86-21-5895-7671 ~ 4 FAX : 86-21-38950165