

Elektrische Eigenschaften / Electrical properties

Höchstzulässige Werte / Maximum rated values

Periodische Spitzenspannung repetitive peak reverse voltage	$t_{vj} = -40^{\circ}\text{C} \dots t_{vj \text{ max}}$ $f = 50\text{Hz}$	V_{RRM}	$-40^{\circ}\text{C} \dots t_{vj \text{ max}}$ 5800 6000 6500 6800	$0^{\circ}\text{C} \dots t_{vj \text{ max}}$ 6000 6200 6700 7000	V V V V
Durchlaßstrom-Grenzeffektivwert RMS forward current		I_{FRMSM}		3400	A
Dauergrenzstrom mean forward current	$t_c = 100^{\circ}\text{C}, f = 50\text{Hz}$ $t_c = 60^{\circ}\text{C}, f = 50\text{Hz}$	I_{FAVM}		1600 2160	A A
Stoßstrom-Grenzwert surge forward current	$t_{vj} = 25^{\circ}\text{C}, t_p = 10\text{ms}$ $t_{vj} = t_{vj \text{ max}}, t_p = 10\text{ms}$	I_{FSM}		23 20	kA kA
Grenzlastintegral I^2t -value	$t_{vj} = 25^{\circ}\text{C}, t_p = 10\text{ms}$ $t_{vj} = t_{vj \text{ max}}, t_p = 10\text{ms}$	I^2t		$2,65 \cdot 10^6$ $2 \cdot 10^6$	A^2s A^2s

Charakteristische Werte / Characteristic values

Durchlaßspannung forward voltage	$t_{vj} = t_{vj \text{ max}}, i_F = 2500\text{A}$	V_F	max	1,9	V
Schleusenspannung threshold voltage	$t_{vj} = t_{vj \text{ max}}$ $i_F = 2500\text{A}$	$V_{(TO)}$		0,88	V
Ersatzwiderstand forward slope resistance	$t_{vj} = t_{vj \text{ max}}$	r_T		0,41	m Ω
Durchlaßrechenkennlinie On-state characteristics for calculation $V_F = A + B \cdot i_F + C \cdot \ln(i_F + 1) + D \cdot \sqrt{i_F}$	$t_{vj} = t_{vj \text{ max}}$	A B C D	max.	0,664047 0,00018532 -0,0375276 0,021268	
Durchlaßrechenkennlinie On-state characteristics for calculation $V_F = A + B \cdot i_F + C \cdot \ln(i_F + 1) + D \cdot \sqrt{i_F}$	$t_{vj} = t_{vj \text{ max}}$	A B C D	typ.	0,699275 0,00016113 -0,043088 0,019719	
Sperrstrom reverse current	$t_{vj} = t_{vj \text{ max}}, V_R = V_{RRM}$	i_R		50	mA
Sperrverzögerungsladung recovered charge	$t_{vj} = t_{vj \text{ max}}$ $I_{TM} = 1000\text{A}, di/dt = 10\text{A}/\mu\text{s}$ $V_R = 1000\text{V}, C = 0,5\mu\text{F}, R = 39 \Omega$	Q_r		11	mAs
Rückstromspitze peak reverse recovery current	$t_{vj} = t_{vj \text{ max}}$ $I_{TM} = 1000\text{A}, di/dt = 10\text{A}/\mu\text{s}$ $V_R = 1000\text{V}, C = 0,5\mu\text{F}, R = 39 \Omega$	I_{RM}		300	A

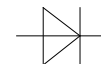

Thermische Eigenschaften / Thermal properties

Innerer Wärmewiderstand thermal resistance, junction to case	beidseitig / two-sided, DC Anode / anode, DC Kathode / cathode, DC	R_{thJC}	max max max	0,014 0,026 0,03	°C/W °C/W °C/W
Übergangs-Wärmewiderstand thermal resistance, case to heatsink	Kühlfläche / cooling surface beidseitig / two-sided einseitig / single sided	R_{thCK}	max max	0,005 0,010	°C/W °C/W
Höchstzulässige Sperrschichttemperatur max. junction temperature		$t_{vj\ max}$		160	°C
Betriebstemperatur operating temperature		$t_{c\ op}$		-40...+160	°C
Lagertemperatur storage temperature		t_{stg}		-40...+160	°C

Mechanische Eigenschaften / Mechanical properties

Gehäuse, siehe Anlage case, see appendix				Seite 3	
Si - Element mit Druckkontakt Si - pellet with pressure contact				55DN65	
Anpreßkraft clamping force		F		15...36	kN
Gewicht weight		G	typ	600	g
Kriechstrecke creepage distance				30	mm
Luftstrecke air distance				20	mm
Feuchtklasse humidity classification	DIN 40040			C	
Schwingfestigkeit vibration resistance	f = 50Hz			50	m/s ²

Mit dieser technischen Information werden Halbleiterbauelemente spezifiziert, jedoch keine Eigenschaften zugesichert. Sie gilt in Verbindung mit den zugehörigen technischen Erläuterungen.
This technical information specifies semiconductor devices but promises no characteristics. It is valid in combination with the belonging technical notes.

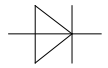

Maßbild / Outline

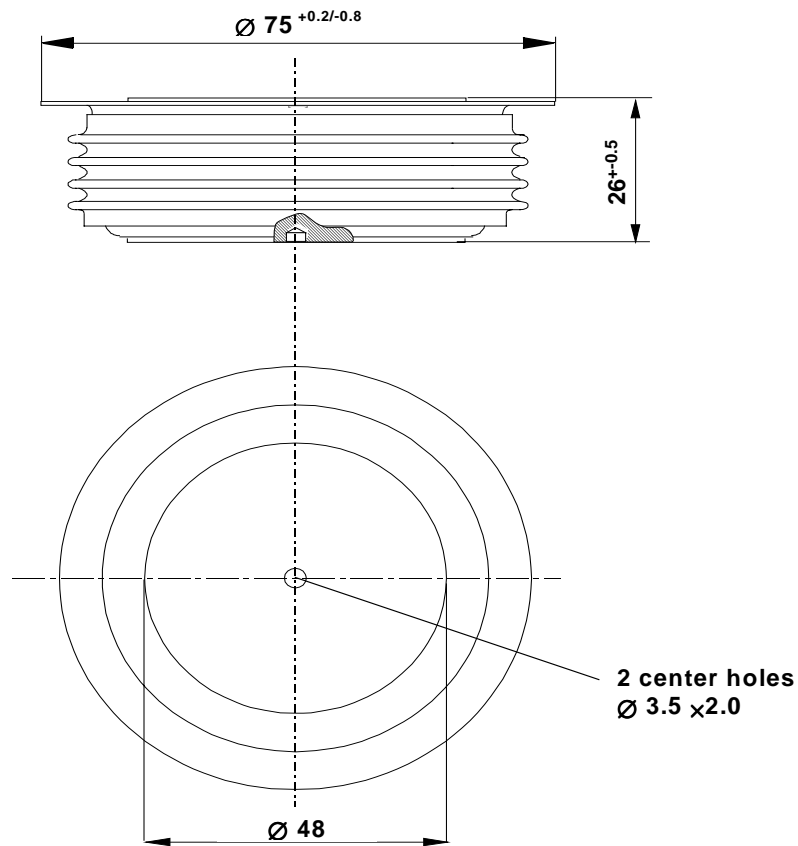

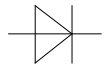

On-State Characteristics (v_F)
typical and upper limit of scatter range

- $t_{vj} = 160^\circ\text{C}$
- - - $t_{vj} = 25^\circ\text{C}$
- - - $r_T @ t_{vj} = 160^\circ\text{C}$

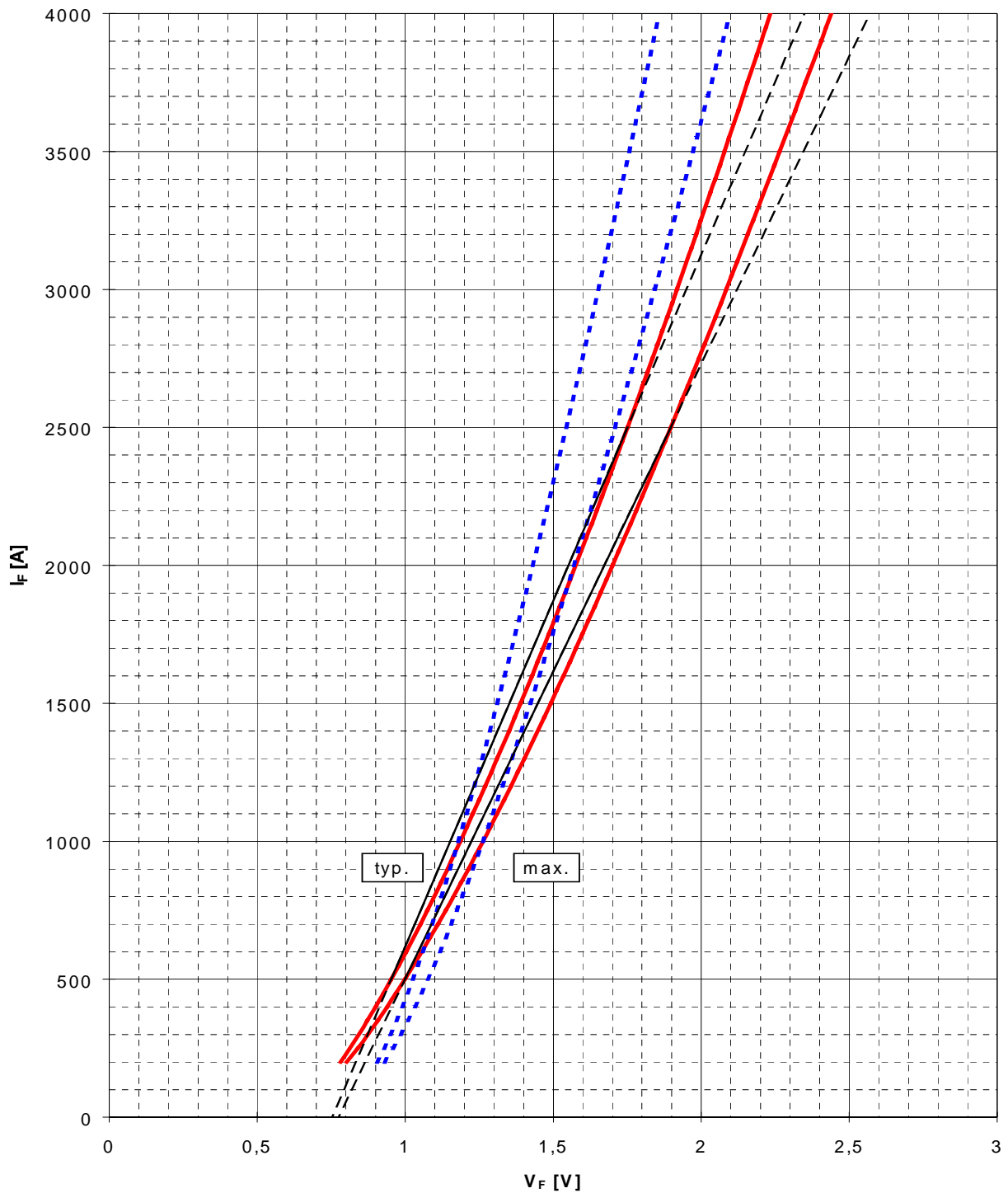

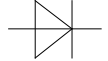

Transient thermal impedance $Z_{(th) JC} = f(t)$

	doppelseitige Kühlung		anodenseitige Kühlung		kathodenseitige Kühlung	
	r [K/W]	[s]	r [K/W]	[s]	r [K/W]	[s]
1	0,00234	0,68	0,01464	6,1	0,01834	4,4
2	0,00667	0,176	0,00667	0,176	0,00667	0,176
3	0,00282	0,0732	0,00282	0,0732	0,00282	0,0732
4	0,00149	0,011	0,00149	0,011	0,00149	0,011
5	0,00068	0,0019	0,00068	0,0019	0,00068	0,0019
	0,014	-	0,0263	-	0,03	-

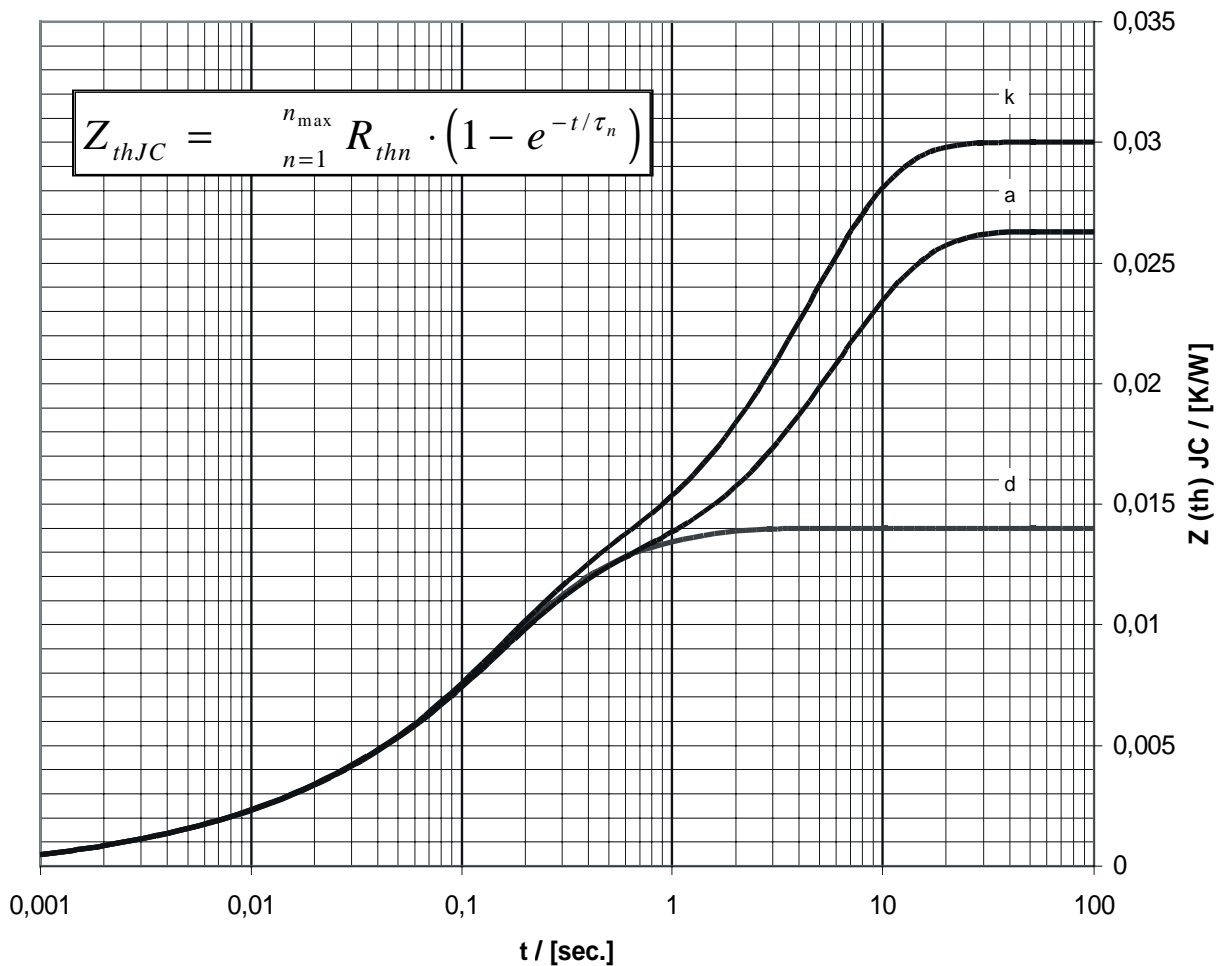

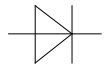

Surge Current Characteristics $I_{FSM} = f(t_p)$
 I^2t value $i^2 dt = f(t_p)$

Sine half-wave, $t_{vj} = 160^\circ C$, $v_R = 0$

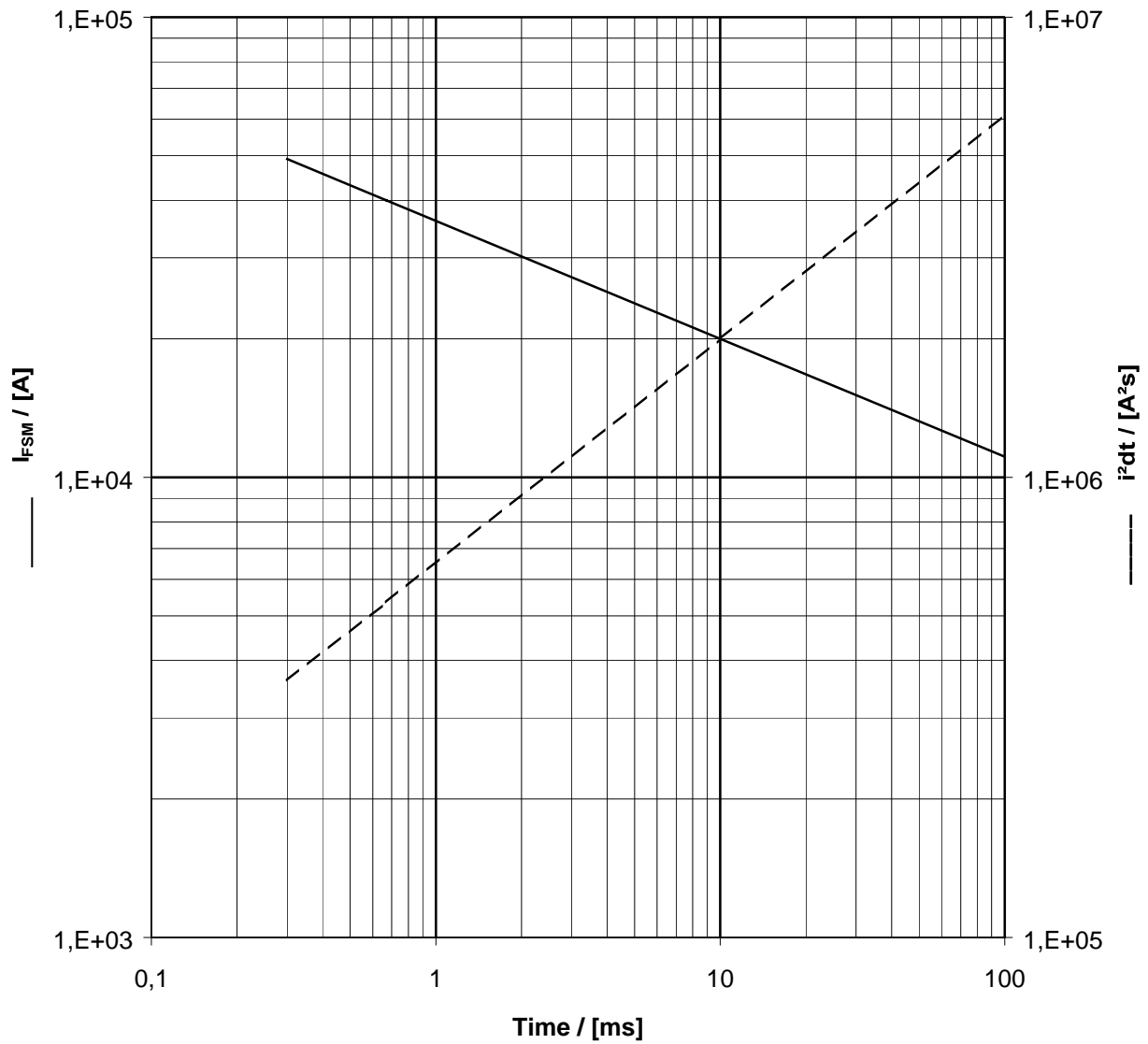

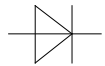

Reverse recovered charge

$$Q_r = f(-di/dt)$$

$t_{vj} = 160^{\circ}\text{C}$, $I_{TM} = 1000\text{A}$, $V_r = 1000\text{V}$, $C = 0,5\mu\text{F}$, $R = 39\Omega$

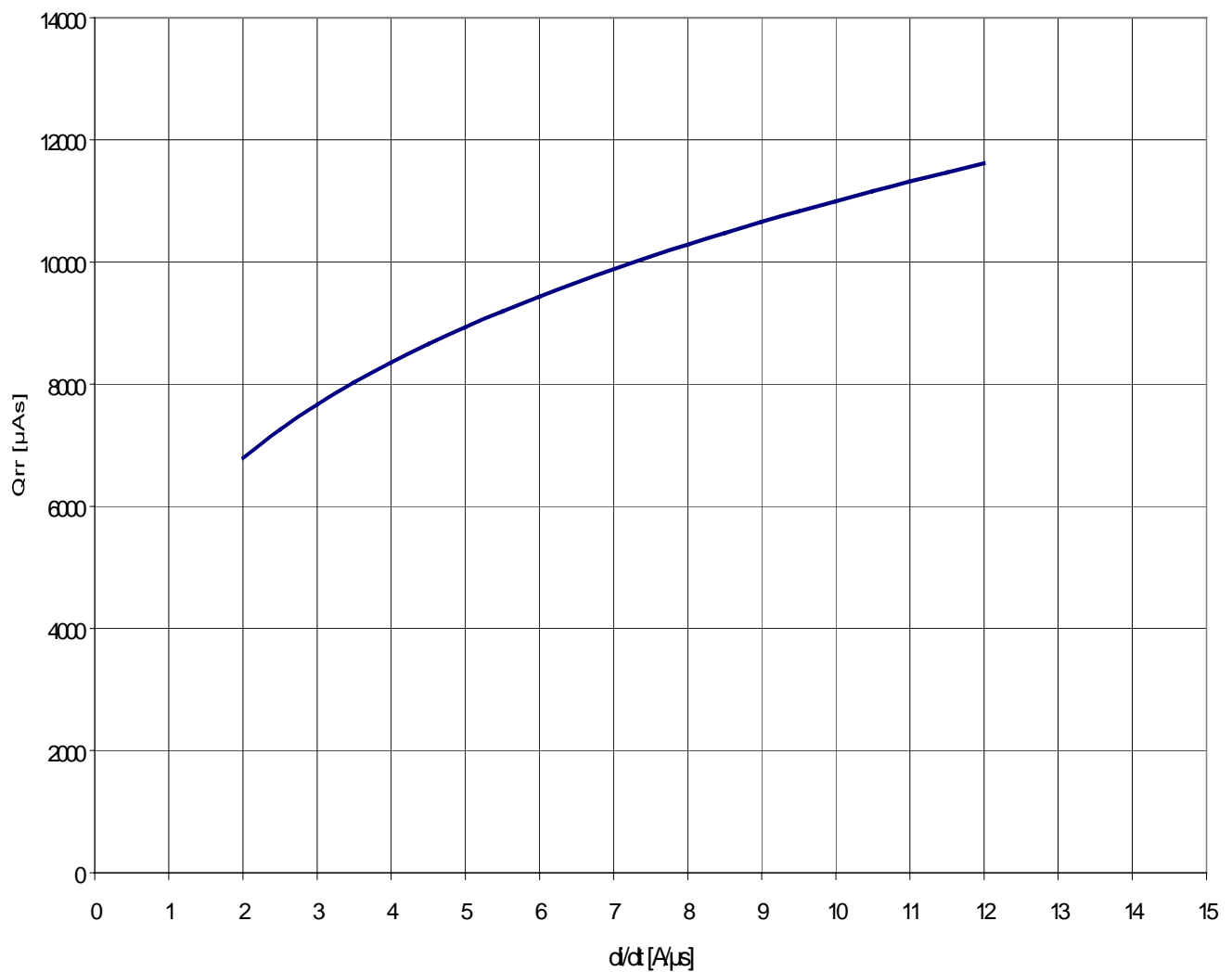

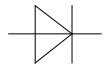

Reverse recovery current

$$I_{RM} = f(-di/dt)$$

$t_{vj} = 160^{\circ}\text{C}$, $I_{TM} = 1000\text{A}$, $V_r = 1000\text{V}$, $C = 0,5\mu\text{F}$, $R = 39\Omega$

