

Dimensions mm[inch]
 tolerances acc. to DIN ISO 2768-m
 Toleranzen gem. DIN ISO 2768-m

Isometric
 Scale 1:2
 Maßstab 1:2

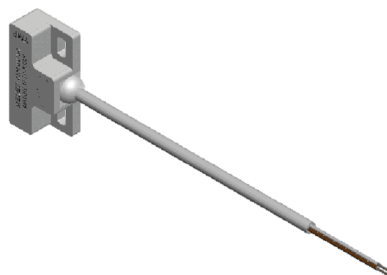
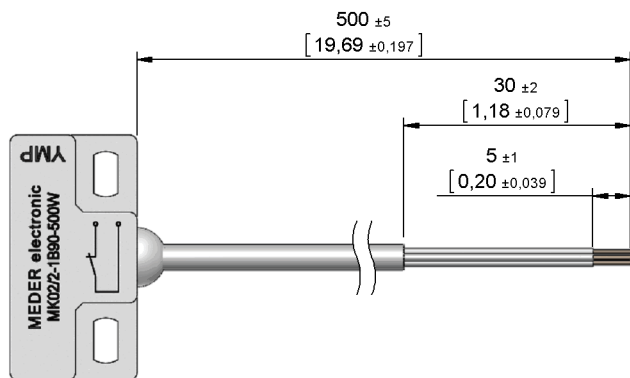

Cable

PVC LIYY 4x0,14qmm
 colour of mantle: white
 colour of wires: white
 PVC LIYY 4x0,14qmm
 Mantelfarbe: weiß
 Aderfarben: weiß

Terminals/Connector

Ends tinned
 Enden verzinkt

Schematic

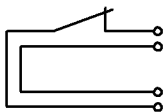

Marking

according to EN60062/factory code
 gem. EN60062/Fertigungsstätte

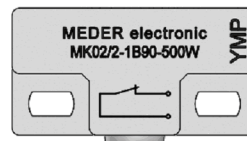

Housing

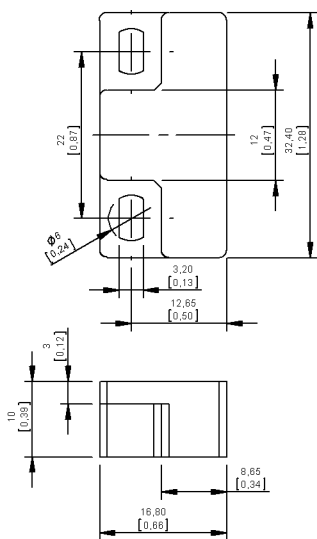

Switching distances

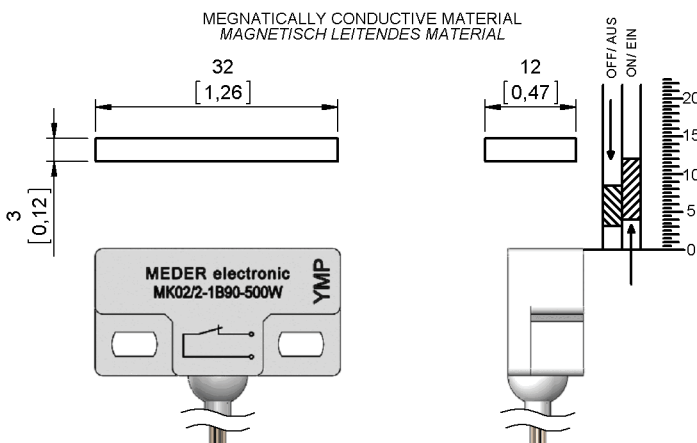



Europe: +49 / 7731 8399 0 | Email: info@meder.com
 USA: +1 / 508 295 0771 | Email: salesusa@meder.com
 Asia: +852 / 2955 1682 | Email: salesasia@meder.com

Item No.:
2222902054
 Item:
MK02/2-1B90-500W

Products for tomorrow...

Magnetic properties	Conditions	Min	Typ	Max	Unit
Pull in	at 20°C	3		8,5	mm
Drop out	at 20°C	4		12	mm
Test equipment		SV 002			

Special Product Data	Conditions	Min	Typ	Max	Unit
Contact - form		B/C - NC			
Contact - No.		90			
Contact rating	Any DC combination of V & A not to exceed their individual max.'s			10	W
operating voltage	DC or Peak AC			175	V
operating ampere	DC or Peak AC			1	A
Switching current	DC or Peak AC			0,5	A
Sensor-resistance	measured with 40% overdrive Sensor deactivated			300	mOhm
Housing material		PBT glass fibre reinforced			
Case color		white			
Sealing compound		Polyurethan			

Environmental data	Conditions	Min	Typ	Max	Unit
Operating temperature	cable not moved	-30		80	°C
Operating temperature	cable moved	-5		80	°C
Storage temperature		-30		80	°C

Cable specification	Conditions	Min	Typ	Max	Unit
Cable typ		round cable			
Cable material		PVC			
Cross section		0,14 qmm			

General data	Conditions	Min	Typ	Max	Unit
Mounting advice		over 5m cable, a series resistor is recommended.			
Mounting advice		Decreased switching distances by mounting on iron.			
Mounting advice		Don't use magnetically conductive screws			
tightening torque	Screw M3 ISO 1207 Disk ISO 7089			0,5	Nm

Modifications in the sense of technical progress are reserved

Designed at: 18.08.08 Designed by: WKOVACS
 Last Change at: 15.11.12 Last Change by: OMUELLER

Approval at: 18.08.08 Approval by: TFRITSCHI
 Approval at: 16.11.12 Approval by: TFRITSCHI

Version: 03