

For air-conditioner fan motor

# 3-Phase Brushless Fan Motor Driver

## BM6203FS

### General Description

This motor driver IC adopts PrestoMOS™ as the output transistor, and put in a small full molding package with the high voltage gate driver chip. The protection circuits for overcurrent, overheating, under voltage lock out and the high voltage bootstrap diode with current regulation are built-in. It provides optimum motor drive system for a wide variety of applications by the combination with controller BD6201X series and enables motor unit standardization.

### Features

- 600V PrestoMOS™ built-in
- Output current 2.5A
- Bootstrap operation by floating high side driver (including diode)
- 3.3V logic input compatible
- Protection circuits provided: OCP, TSD and UVLO
- Fault output (open drain)

### Applications

- Air conditioners; air cleaners; water pumps; dishwashers; washing machines
- General OA equipment

### Key Specifications

- Output MOSFET Voltage: 600V
- Driver Output Current (DC): ±2.5A (Max)
- Driver Output Current (Pulse): ±4.0A (Max)
- Output MOSFET DC On Resistance: 1.7Ω (Typ)
- Operating Case Temperature: -20°C to +100°C
- Junction Temperature: +150°C
- Power Dissipation: 3.00W

### Package

SSOP-A54\_23

W (Typ) x D (Typ) x H (Max)  
22.0 mm x 14.1 mm x 2.4 mm

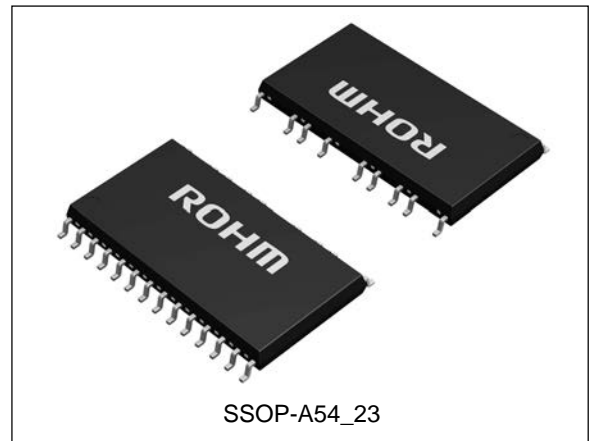

SSOP-A54\_23

### Typical Application Circuit

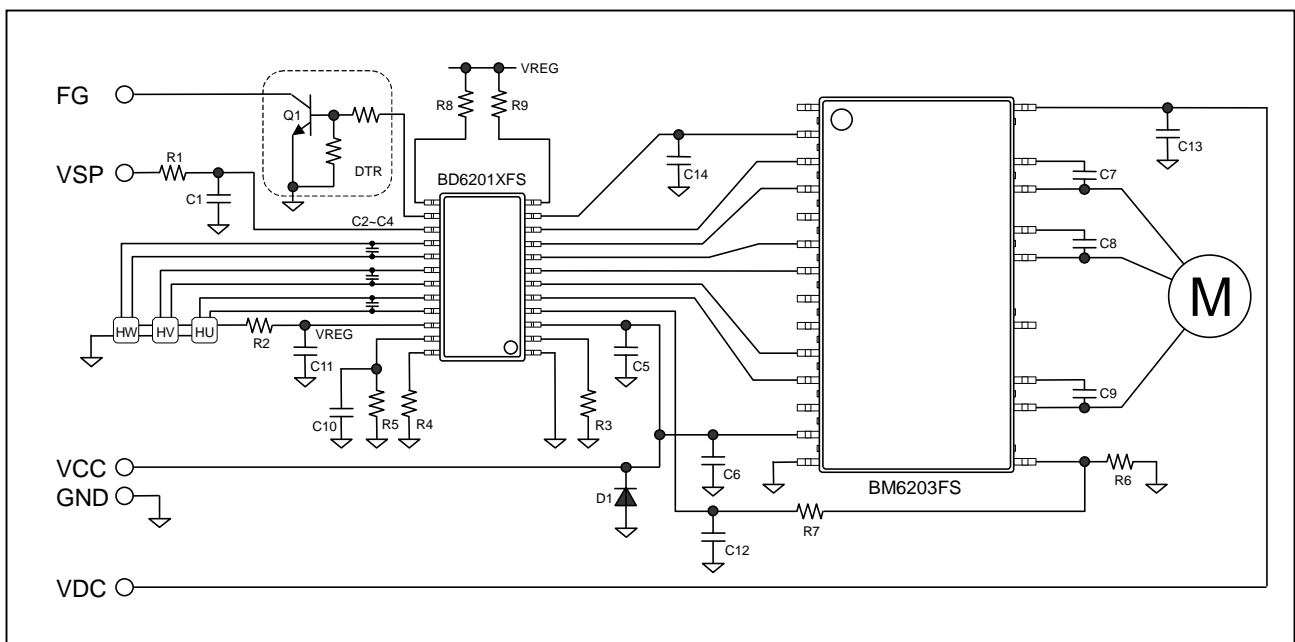

Figure 1. Application Circuit Example - BM6203FS & BD6201XFS

Block Diagram and Pin Configuration

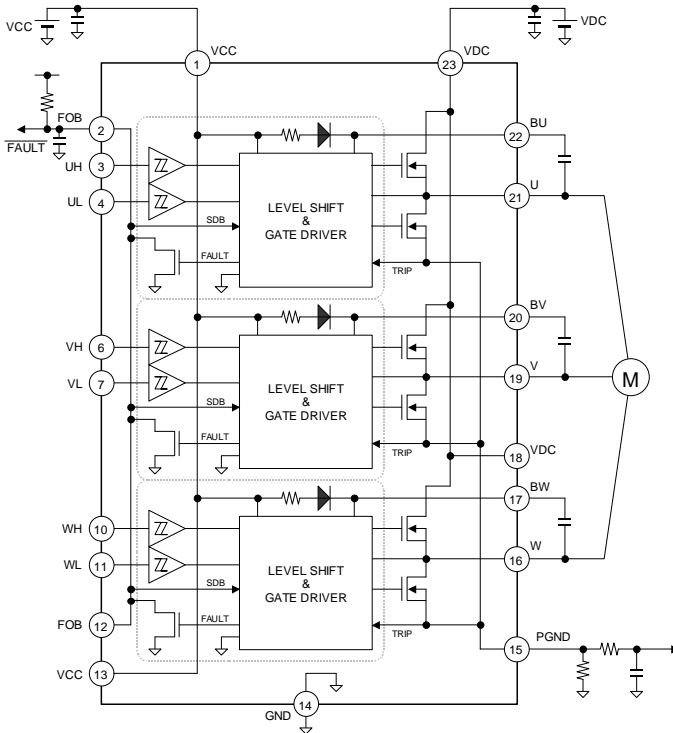

Figure 2. Block Diagram

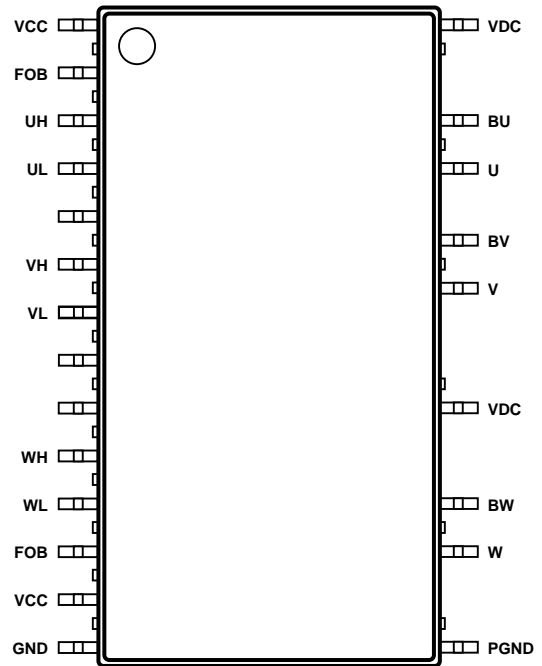

Figure 3. Pin Configuration (Top View)

Pin Descriptions (NC: No Connection)

Pin	Name	Function	Pin	Name	Function
1	VCC	Low voltage power supply	23	VDC	High voltage power supply
2	FOB	Fault signal output (open drain)	-	VDC	
3	UH	Phase U high side control input	22	BU	Phase U floating power supply
4	UL	Phase U low side control input	-	U	
5	NC		21	U	Phase U output
6	VH	Phase V high side control input	20	BV	Phase V floating power supply
7	VL	Phase V low side control input	-	V	
8	NC		19	V	Phase V output
9	NC		-	VDC	
10	WH	Phase W high side control input	18	VDC	High voltage power supply
11	WL	Phase W low side control input	17	BW	Phase W floating power supply
12	FOB	Fault signal output (open drain)	-	W	
13	VCC	Low voltage power supply	16	W	Phase W output
14	GND	Ground	15	PGND	Ground (current sense pin)

Note) All pin cut surfaces visible from the side of package are no connected, except the pin number is expressed as a "-".

Functional Descriptions

1. Control Input Pins (UH, UL, VH, VL, WH, WL)

The input threshold voltages of the control pins are 2.5V and 0.8V, with a hysteresis voltage of approximately 0.4V. The IC will accept input voltages up to the VCC voltage. When the same phase control pins are input high at the same time, the high side and low side gate driver outputs become low. Dead time is installed in the control signals. The control input pins are connected internally to pull-down resistors (100kΩ nominal). However, the switching noise on the output stage may affect the input on these pins and cause undesired operation. In such cases, attaching an external pull-down resistor (10kΩ recommended) between each control pin and ground, or connecting each pin to an input voltage of 0.8V or less (preferably GND), is recommended.

Truth Table

HIN	LIN	HO	LO
L	L	L	L
H	L	H	L
L	H	L	H
H	H	Inhibition	

Note) HIN: UH,VH,WH, LIN: UL,VL,WL

2. Under Voltage Lock Out (UVLO) Circuit

To secure the lowest power supply voltage necessary to operate the driver, and to prevent under voltage malfunctions, the UVLO circuits are independently built into the upper side floating driver and the lower side driver. When the supply voltage falls to  $V_{UVL}$  or below, the controller forces driver outputs low. When the voltage rises to  $V_{UVH}$  or above, the UVLO circuit ends the lockout operation and returns the chip to normal operation. Even if the controller returns to normal operation, the output begins from the following control input signal.

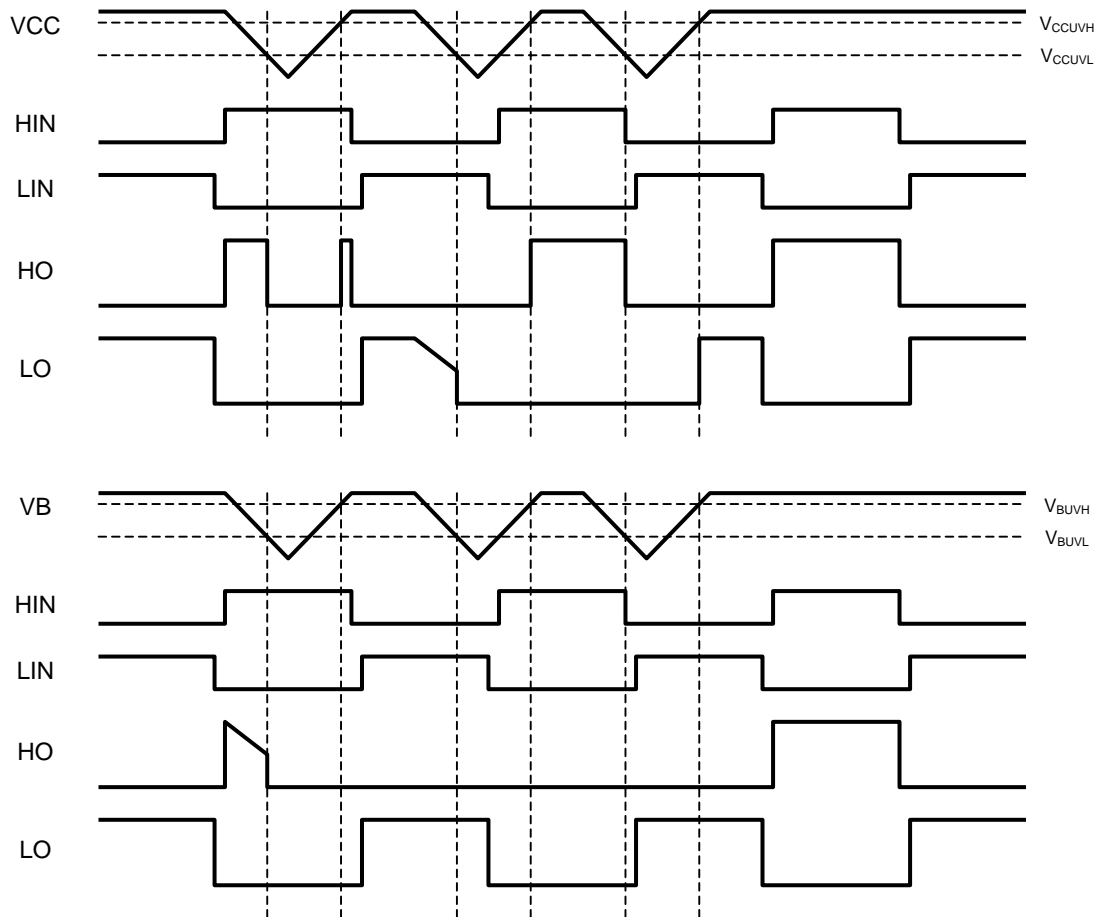

Figure 4. Low Voltage Monitor - UVLO - Timing Chart

3. Bootstrap Operation

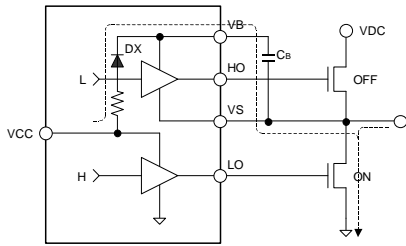

Figure 5. Charging Period

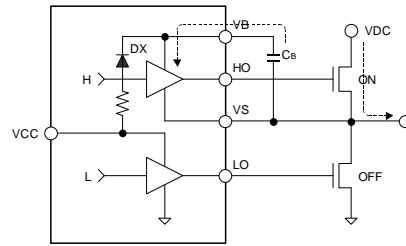
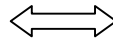

Figure 6. Discharging Period

The bootstrap is operated by the charge period and the discharge period being alternately repeated for bootstrap capacitor (CB) as shown in the figure above. In a word, this operation is repeated while the output of an external transistor is switching with synchronous rectification. Because the supply voltage of the floating driver is charged from the VCC power supply to CB through prevention of backflow diode DX, it is approximately (VCC-1V). The resistance series connection with DX has the impedance of approximately 200 Ω.

The capacitance value for the bootstrap is the following formula:

$$C_{BOOT} \gg \frac{(I_{BBQ} + I_{LBD})}{F_{PWM}} + 2 \times Q_g + Q_{LOSS} \approx 36nF$$

$\Delta V_{DROP}$

where, for example:

$I_{BBQ}$  is the floating driver power supply quiescence current, 150μA(Max)

$I_{LBD}$  is the bootstrap diode reverse bias current, 10μA(Max)

$F_{PWM}$  is the carrier frequency, 20kHz

$Q_g$  is the output MOSFET total gate charge, 50nC(Max)

$Q_{LOSS}$  is the floating driver transmission loss, 1nC(Max)

$\Delta V_{DROP}$  is the drop voltage of the floating driver power supply, 3V

The allowed drop voltage actually becomes smaller by the range of the used power supply voltage, the output MOSFET ON resistance, the forward voltages of the internal boot diode (the drop voltage to the capacitor by the charge current), and the power supply voltage monitor circuits etc. Please set the calculation value to the criterion about the capacitance value tenfold or more to secure the margin in consideration of temperature characteristics and the value change, etc. Moreover, the example of the mentioned above assumes the synchronous rectification switching. Because the total gate charge is needed only by the carrier frequency in the upper switching section, for example 150° commutation driving, it becomes a great capacity shortage in the above settings. Please set it after confirming actual application operation.

4. Thermal Shutdown (TSD) Circuit

The TSD circuit operates when the junction temperature of the gate driver exceeds the preset temperature (150°C nominal). At this time, the controller forces all driver outputs low. Since thermal hysteresis is provided in the TSD circuit, the chip returns to normal operation when the junction temperature falls below the preset temperature (125°C nominal). The TSD circuit is designed only to shut the IC off to prevent thermal runaway. It is not designed to protect the IC or guarantee its operation in the presence of extreme heat. Do not continue using the IC after the TSD circuit is activated, and do not use the IC in an environment where activation of the circuit is assumed. Moreover, it is not possible to follow the output MOSFET junction temperature rising rapidly because it is a gate driver chip that monitors the temperature and it is likely not to function effectively.

5. Overcurrent Protection (OCP) Circuit

The overcurrent protection circuit can be activated by connecting a low value resistor for current detection between the PGND pin and the GND pin. When the PGND pin voltage reaches or surpasses the threshold value (0.9V typical), the gate driver outputs low to the gate of all output MOSFETs, thus initiating the overcurrent protection operation.

6. Fault Signal Output

When the gate driver detects either state that should be protected (UVLO / TSD / OCP), the FOB pin outputs low (open drain) for at least 25µs nominal. The FOB pin has wired-OR connection with each phase gate driver chip internally, and into another phase also entering the protection operation. Even when this function is not used, the FOB pin is pull-up to the voltage of 3V or more and at least a resistor with a value 10k Ω or more. Moreover, the signal from the outside of the chip is not passed because of the built-in analog filter, but the internal control signals (UVLO / TSD / OCP) pass the filter (2.0µs Min.) for the malfunction prevention by the switching noise, etc.

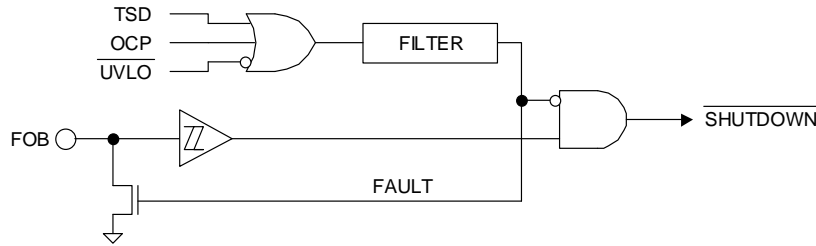

Figure 7. Fault Signal Bi-Directional Input Pin Interface

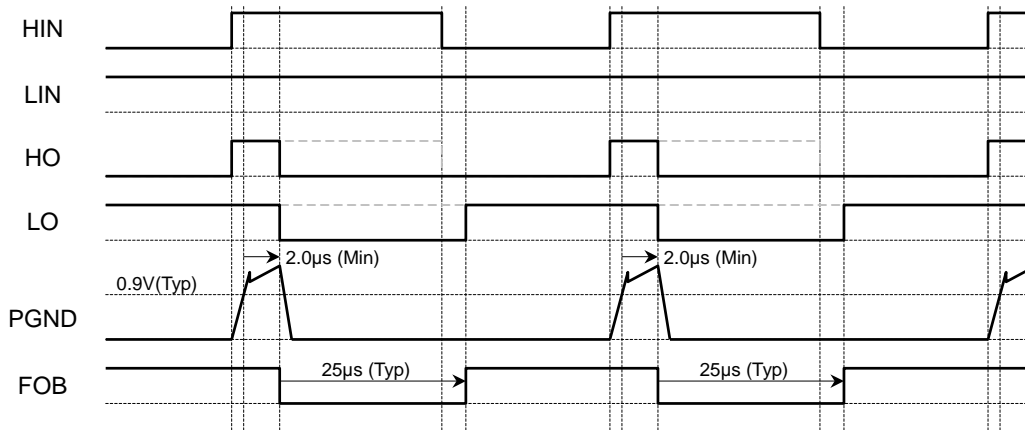

Figure 8. Fault Operation ~ OCP ~ Timing Chart

The release time from the protection operation can be changed by inserting an external capacitor. Refer to the formula below. Release time of 5ms or more is recommended.

$$t = -\ln\left(1 - \frac{2.0}{VPU}\right) \cdot R \cdot C \text{ [s]}$$

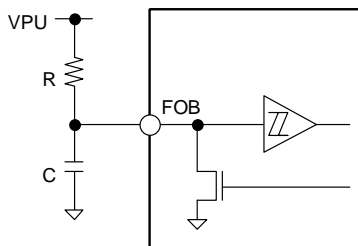

Figure 9. Release Time Setting Application Circuit

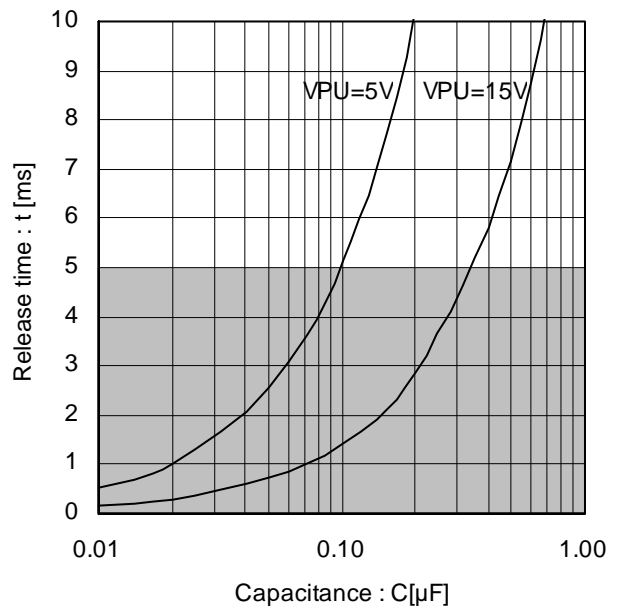

Figure 10. Release Time (Reference Data @R=100kΩ)

When using controller BD6201X series as a control IC, the FOB pin can be linked to the external fault signal input pin of the side of the control IC since it has the internal pull-up resistor. Refer to figure 11.

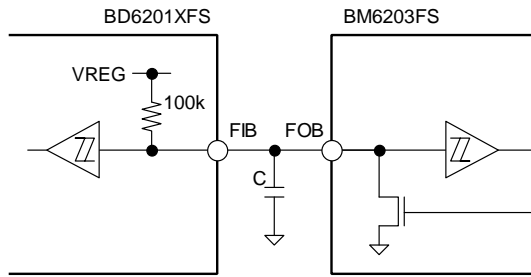

Figure 11. Interface Equivalent Circuit

7. Switching Time

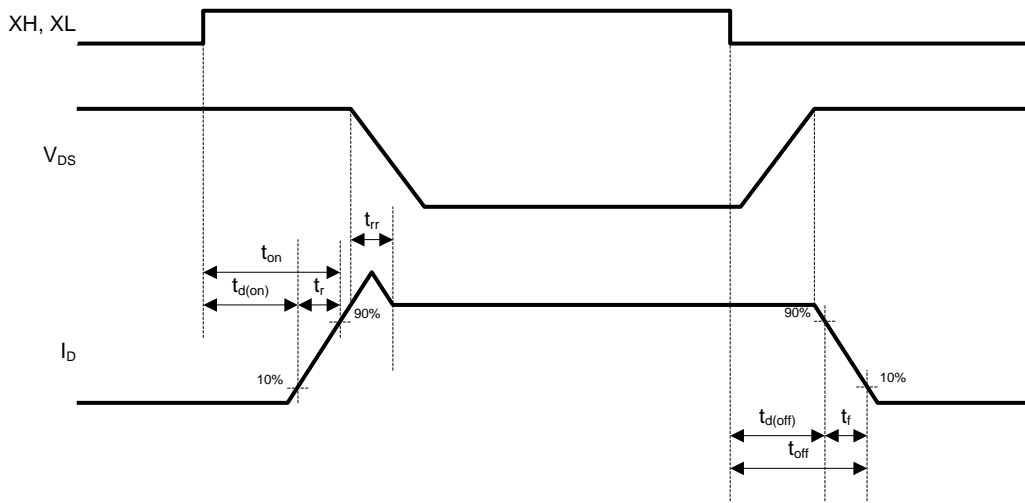

Figure 12. Switching Time Definition

Parameter	Symbol	Reference	Unit	Conditions
High Side Switching Time	$t_{dH(on)}$	770	ns	VDC=300V, VCC=15V, I <sub>D</sub> =1.25A VIN= 0V↔5V, Inductive load
	$t_{rH}$	130	ns	
	$t_{rrH}$	180	ns	
	$t_{dH(off)}$	660	ns	
	$t_{fH}$	30	ns	
Low Side Switching Time	$t_{dL(on)}$	830	ns	
	$t_{rL}$	140	ns	
	$t_{rrL}$	180	ns	
	$t_{dL(off)}$	740	ns	
	$t_{fL}$	30	ns	

## Absolute Maximum Ratings (Ta=25°C)

Parameter	Symbol	Ratings		Unit
		BM6203FS		
Output MOSFET	V <sub>DSS</sub>	600 <sup>(Note 1)</sup>		V
Supply Voltage	V <sub>DC</sub>	-0.3 to +600 <sup>(Note 1)</sup>		V
Output Voltage	V <sub>U</sub> , V <sub>V</sub> , V <sub>W</sub>	-0.3 to +600 <sup>(Note 1)</sup>		V
High Side Supply Pin Voltage	V <sub>BU</sub> , V <sub>BV</sub> , V <sub>BW</sub>	-0.3 to +600 <sup>(Note 1)</sup>		V
High Side Floating Supply Voltage	V <sub>BU</sub> -V <sub>U</sub> , V <sub>BV</sub> -V <sub>V</sub> , V <sub>BW</sub> -V <sub>W</sub>	-0.3 to +20		V
Low Side Supply Voltage	V <sub>CC</sub>	-0.3 to +20		V
All Others	V <sub>I/O</sub>	-0.3 to V <sub>CC</sub>		V
Driver Outputs (DC)	I <sub>OMAX(DC)</sub>	±2.5 <sup>(Note 1)</sup>		A
Driver Outputs (Pulse)	I <sub>OMAX(PLS)</sub>	±4.0 <sup>(Note 2)</sup>		A
Fault Signal Output	I <sub>OMAX(FOB)</sub>	15 <sup>(Note 1)</sup>		mA
Power Dissipation	P <sub>d</sub>	3.00 <sup>(Note 3)</sup>		W
Thermal Resistance	R <sub>thj-c</sub>	15		°C/W
Operating Case Temperature	T <sub>C</sub>	-20 to +100		°C
Storage Temperature	T <sub>STG</sub>	-55 to +150		°C
Junction Temperature	T <sub>jmax</sub>	150		°C

(Note) All voltages are with respect to ground.

(Note 1) Do not, however, exceed P<sub>d</sub> or ASO.

(Note 2) P<sub>w</sub> ≤ 10μs, Duty cycle ≤ 1%

(Note 3) Mounted on a 70mm x 70mm x 1.6mm FR4 glass-epoxy board with less than 3% copper foil. Derated at 24mW/°C above 25°C.

Caution: Operating the IC over the absolute maximum ratings may damage the IC. The damage can either be a short circuit between pins or an open circuit between pins and the internal circuitry. Therefore, it is important to consider circuit protection measures, such as adding a fuse, in case the IC is operated over the absolute maximum ratings.

Operating Conditions (T<sub>C</sub>=25°C)

Parameter	Symbol	Range			Unit
		Min.	Typ.	Max.	
Supply Voltage	V <sub>DC</sub>	-	310	400	V
High Side Floating Supply Voltage	V <sub>BU</sub> -V <sub>U</sub> , V <sub>BV</sub> -V <sub>V</sub> , V <sub>BW</sub> -V <sub>W</sub>	13.5	15	16.5	V
Low Side Supply Voltage	V <sub>CC</sub>	13.5	15	16.5	V
Minimum Input Pulse Width	T <sub>MIN</sub>	0.8	-	-	μs
Dead Time	T <sub>DT</sub>	1.5	-	-	μs
Shunt Resistor (PGND)	R <sub>S</sub>	0.5	-	-	Ω
Junction Temperature	T <sub>j</sub>	-	-	125	°C

(Note) All voltages are with respect to ground.

## Electrical Characteristics (Unless otherwise specified, Ta=25°C and VCC=15V)

Parameter	Symbol	Limits			Unit	Conditions
		Min.	Typ.	Max.		
<b>Power Supply</b>						
HS Quiescence Current	I <sub>BBQ</sub>	30	70	150	μA	XH=XL=L, each phase
LS Quiescence Current	I <sub>CCQ</sub>	0.4	0.9	1.5	mA	XH=XL=L
<b>Output MOSFET</b>						
D-S Breakdown Voltage	V <sub>(BR)DSS</sub>	600	-	-	V	I <sub>D</sub> =1mA, XH=XL=L
Leak Current	I <sub>DSS</sub>	-	-	100	μA	V <sub>DS</sub> =600V, XH=XL=L
DC ON Resistance	R <sub>DS(ON)</sub>	-	1.7	2.5	Ω	I <sub>D</sub> =1.25A
Diode Forward Voltage	V <sub>SD</sub>	-	1.1	1.5	V	I <sub>D</sub> =1.25A
<b>Bootstrap Diode</b>						
Leak Current	I <sub>LBD</sub>	-	-	10	μA	V <sub>BX</sub> =600V
Forward Voltage	V <sub>FBD</sub>	1.5	1.8	2.1	V	I <sub>BD</sub> =-5mA, including series-R
Series Resistance	R <sub>BD</sub>	-	200	-	Ω	
<b>Control Inputs</b>						
Input Bias Current	I <sub>XIN</sub>	30	50	70	μA	V <sub>IN</sub> =5V
Input High Voltage	V <sub>XINH</sub>	2.5	-	VCC	V	
Input Low Voltage	V <sub>XINL</sub>	0	-	0.8	V	
<b>Under Voltage Lock Out</b>						
HS Release Voltage	V <sub>BUVH</sub>	9.5	10.0	10.5	V	V <sub>BX</sub> - V <sub>X</sub>
HS Lockout Voltage	V <sub>BUVL</sub>	8.5	9.0	9.5	V	V <sub>BX</sub> - V <sub>X</sub>
LS Release Voltage	V <sub>CCUVH</sub>	11.0	11.5	12.0	V	
LS Lockout Voltage	V <sub>CCUVL</sub>	10.0	10.5	11.0	V	
<b>Overcurrent Protection</b>						
Threshold Voltage	V <sub>SNS</sub>	0.8	0.9	1.0	V	
<b>Fault Output</b>						
Output Low Voltage	V <sub>FOL</sub>	-	-	0.8	V	I <sub>O</sub> =+10mA
Input High Voltage	V <sub>FINH</sub>	2.5	-	VCC	V	
Input Low Voltage	V <sub>FINL</sub>	0	-	0.8	V	
Noise Masking Time	T <sub>MASK</sub>	2.0	-	-	μs	



Typical Performance Curves (Reference data)

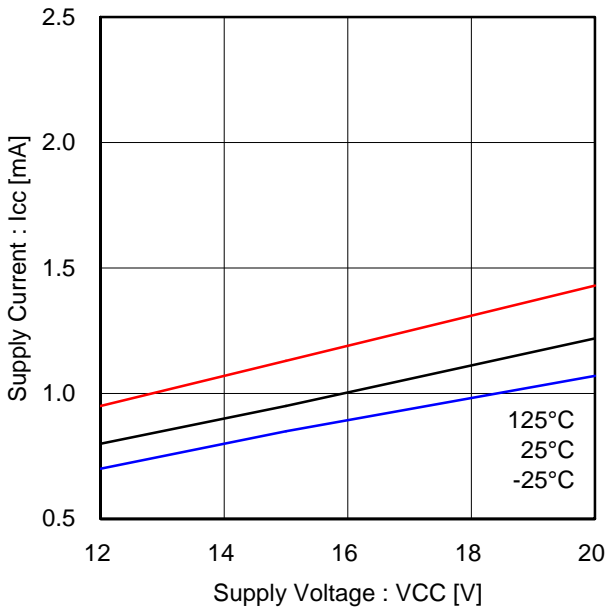

Figure 13. Quiescence Current (Low Side Drivers)

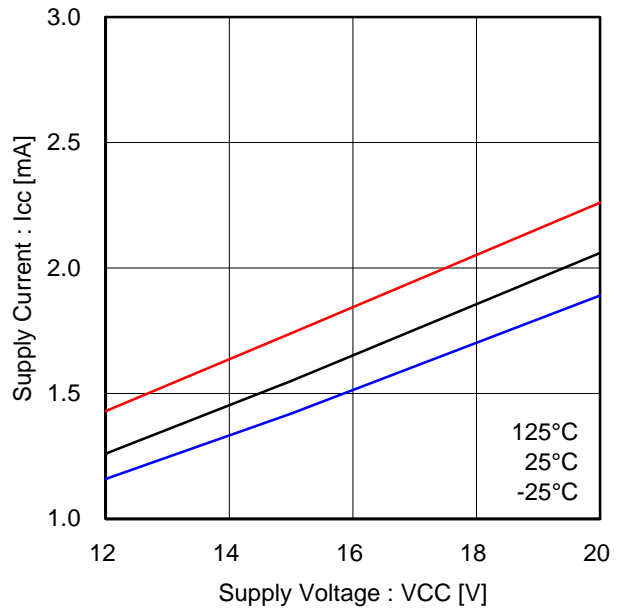

Figure 14. Low Side Drivers Operating Current (F<sub>PWM</sub>: 20kHz, One-Phase Switching)

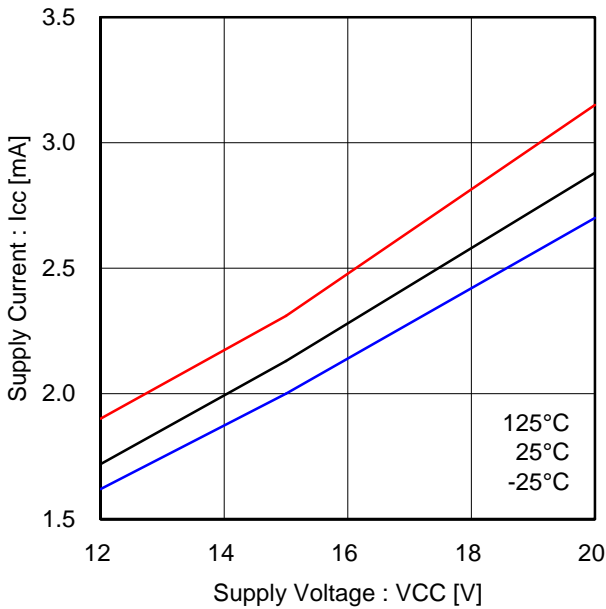

Figure 15. Low Side Drivers Operating Current (F<sub>PWM</sub>: 20kHz, Two-Phase Switching)

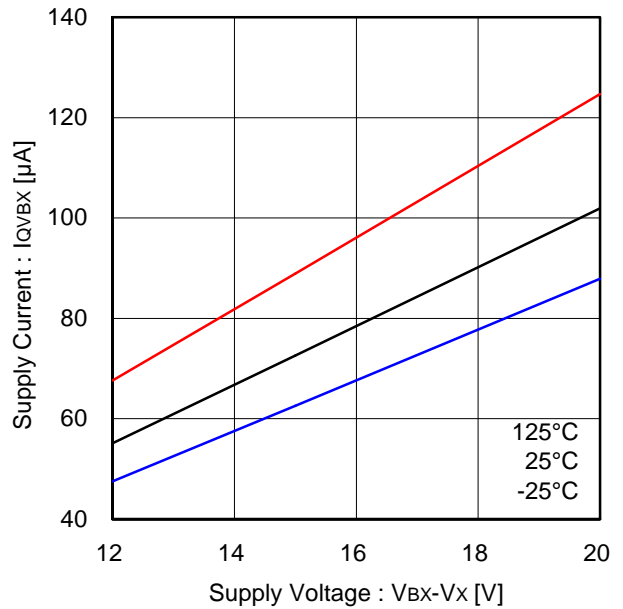

Figure 16. Quiescence Current (High Side Driver, Each Phase)

Typical Performance Curves (Reference data) - Continued

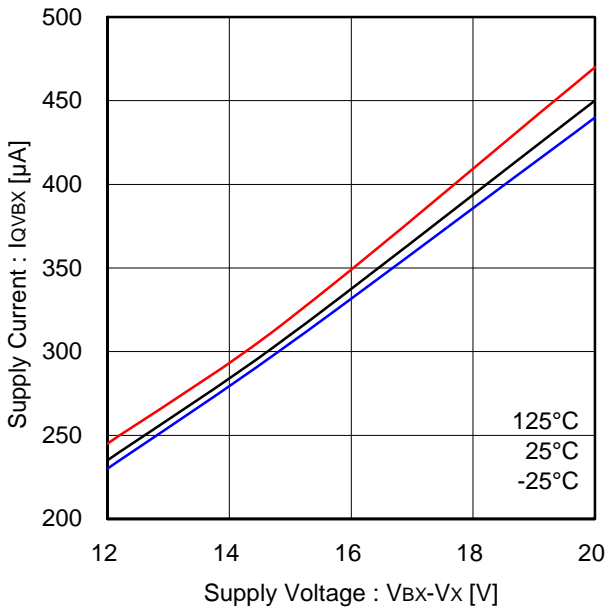

Figure 17. High Side Driver Operating Current (F<sub>PWM</sub>: 20kHz, Each Phase)

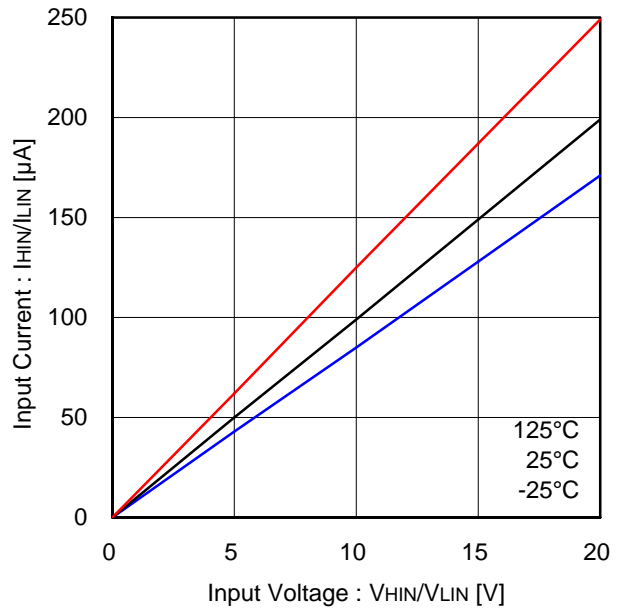

Figure 18. Input Bias Current (UH,UL,VH,VL,WH,WL)

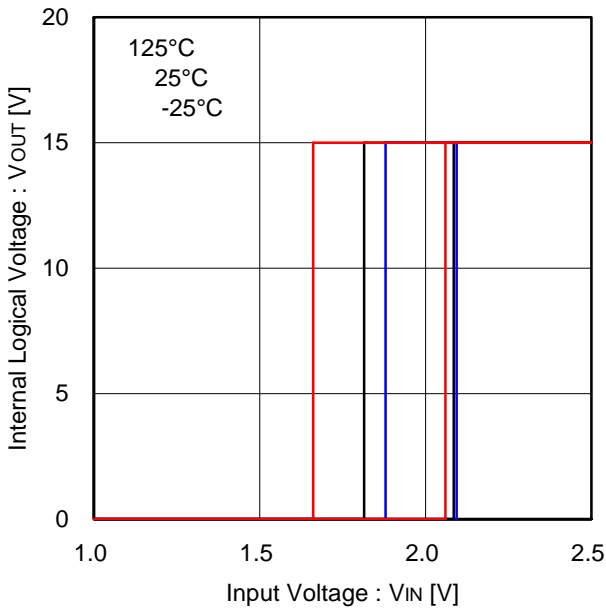

Figure 19. Input Threshold Voltage (UH,UL,VH,VL,WH,WL,FOB)

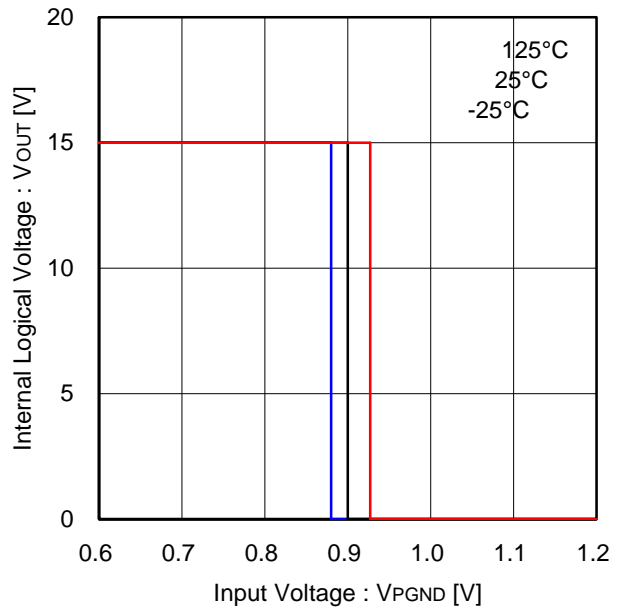

Figure 20. Overcurrent Detection Voltage

Typical Performance Curves (Reference data) - Continued

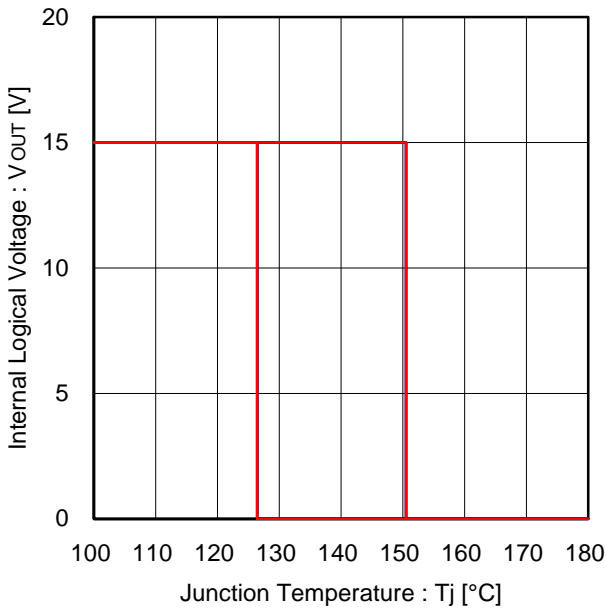

Figure 21. Thermal Shut Down

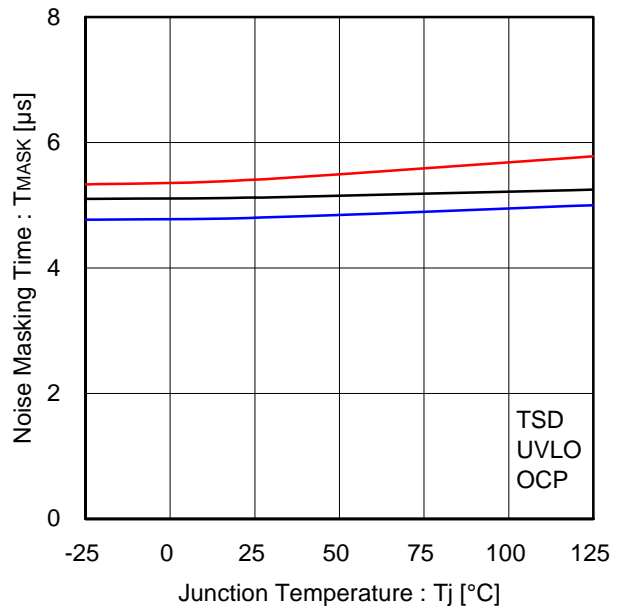

Figure 22. Noise Masking Time

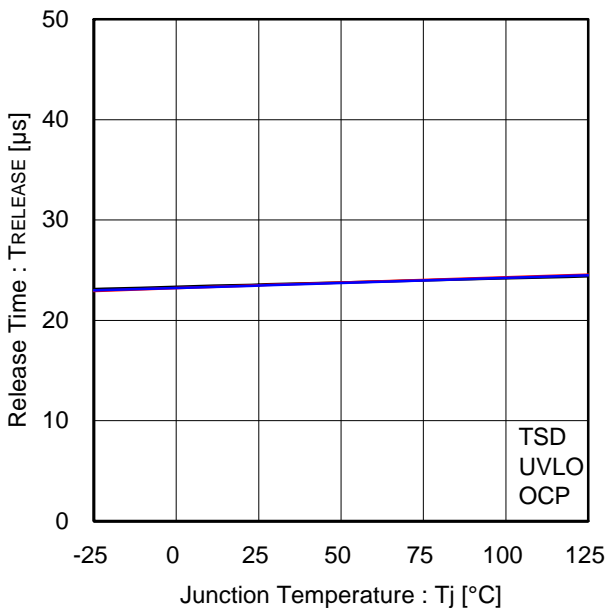

Figure 23. Release Time (No External Capacitor)

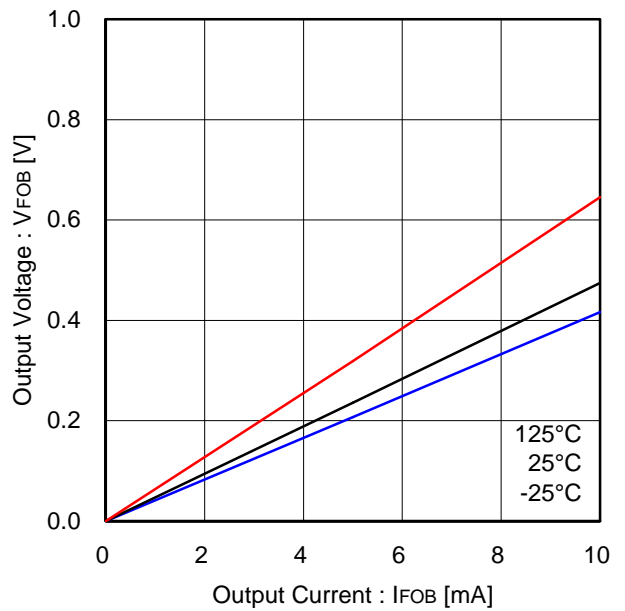

Figure 24. Fault Output ON Resistance

Typical Performance Curves (Reference data) - Continued

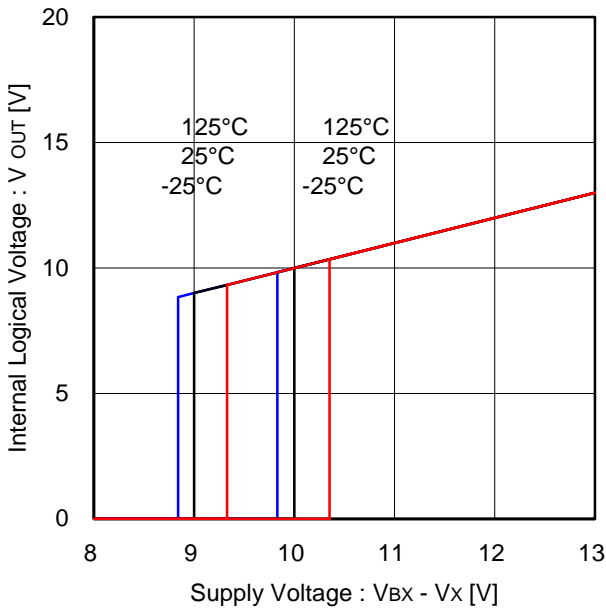

Figure 25. Under Voltage Lock Out (High Side Driver, Each Phase)

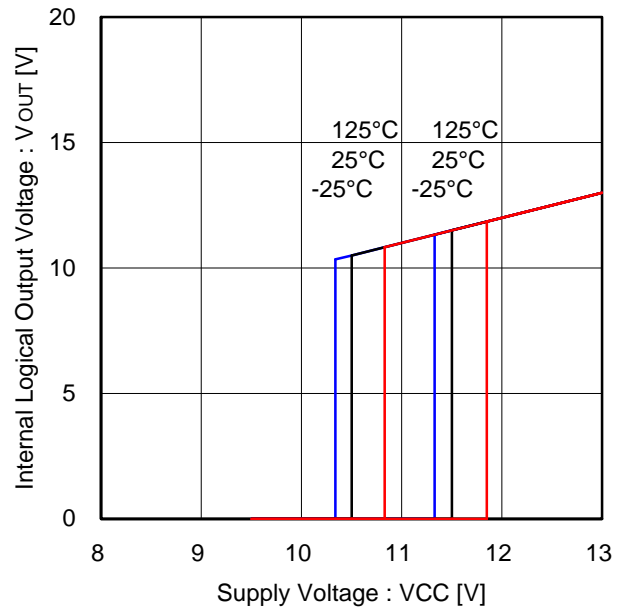

Figure 26. Under Voltage Lock Out (Low Side Drivers)

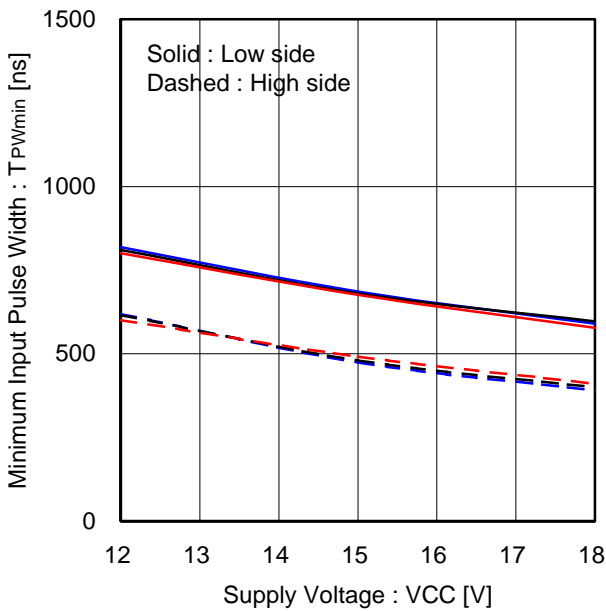

Figure 27. Minimum Input Pulse Width

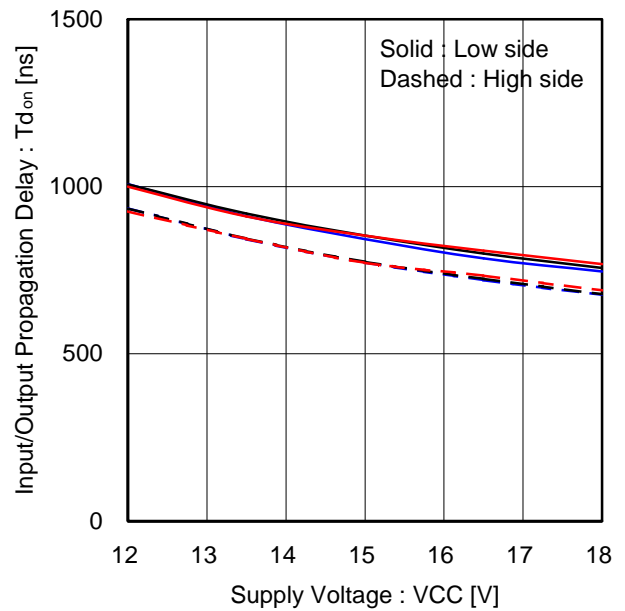

Figure 28. Input/Output Propagation Delay (On Delay)

Typical Performance Curves (Reference data) - Continued

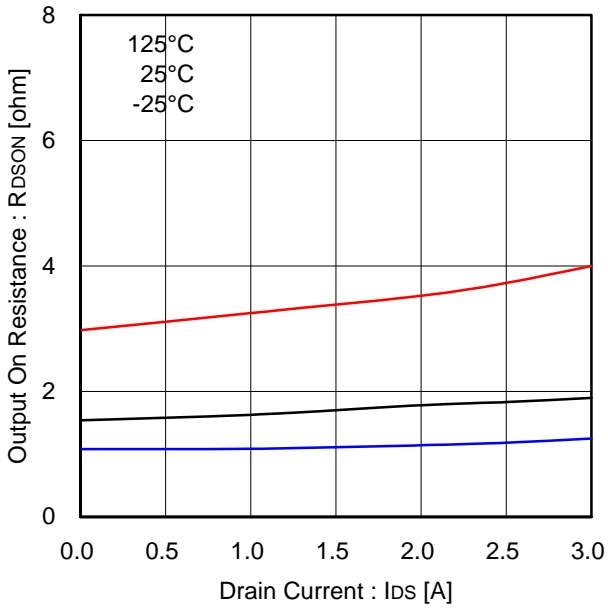

Figure 29. Output MOSFET ON Resistance

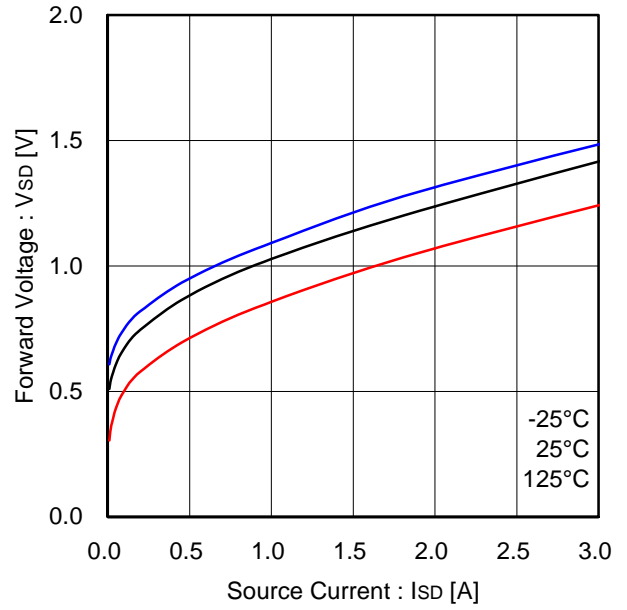

Figure 30. Output MOSFET Body Diode

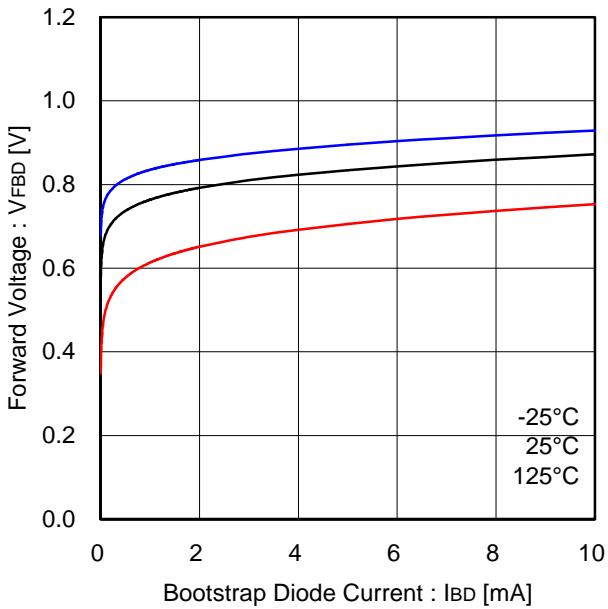

Figure 31. Bootstrap Diode Forward Voltage

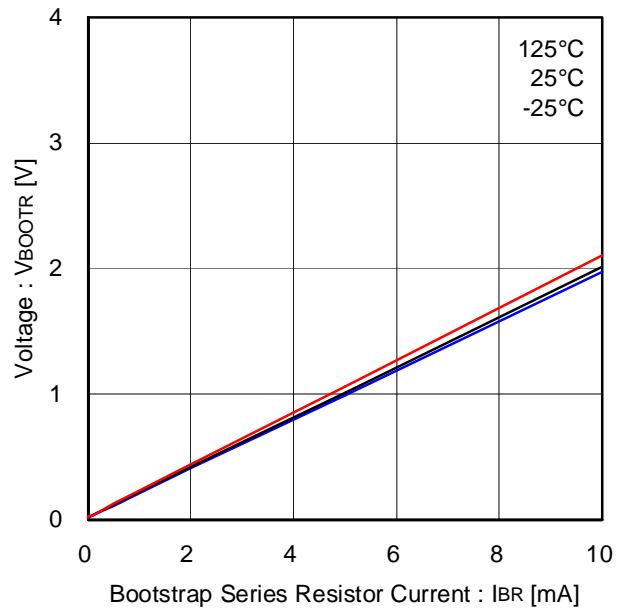

Figure 32. Bootstrap Series Resistor

Typical Performance Curves (Reference data) - Continued

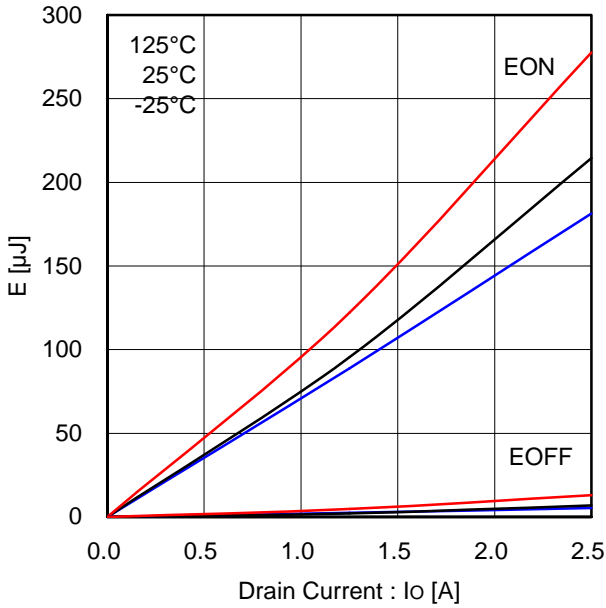

Figure 33. High Side Switching Loss (VDC=300V)

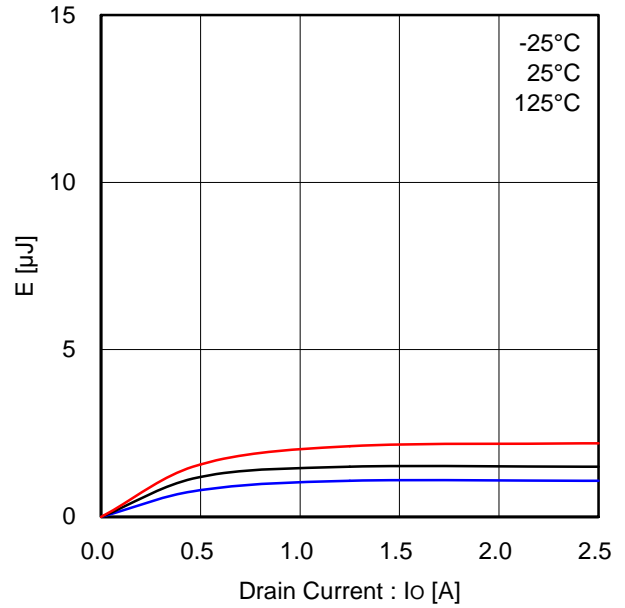

Figure 34. High Side Recovery Loss (VDC=300V)

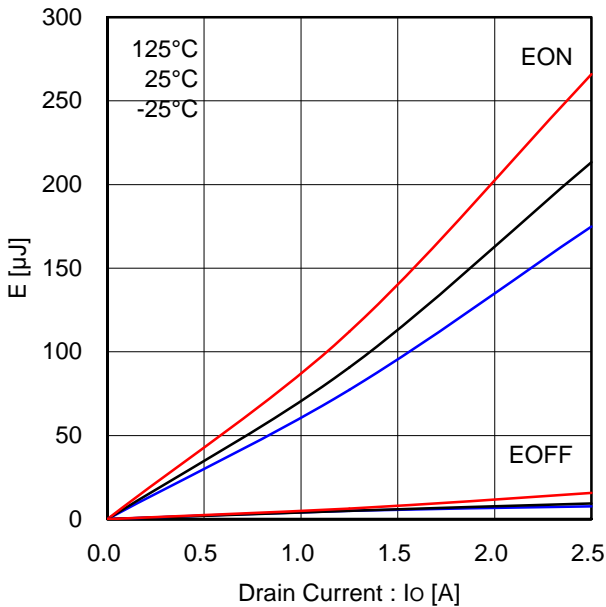

Figure 35. Low Side Switching Loss (VDC=300V)

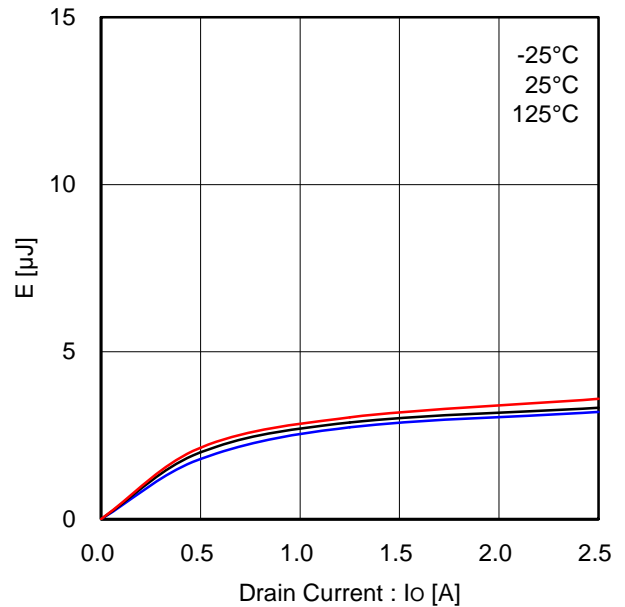

Figure 36. Low Side Recovery Loss (VDC=300V)

Application Circuit Example

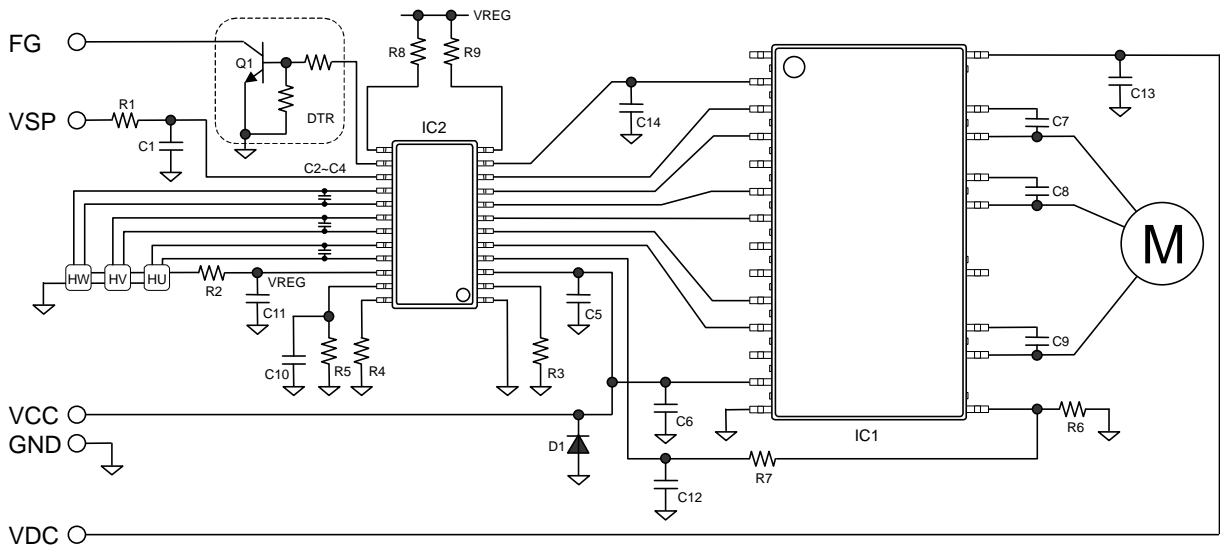

Figure 37. Application Circuit Example (150° Commutation Driver)

Parts List

Parts	Value	Manufacturer	Type	Parts	Value	Ratings	Type
IC1	-	ROHM	BM6203FS	C1	0.1μF	50V	Ceramic
IC2	-	ROHM	BD62012FS	C2-4	2200pF	50V	Ceramic
R1	1kΩ	ROHM	MCR18EZPF1001	C5	10 μF	50V	Ceramic
R2	150Ω	ROHM	MCR18EZPJ151	C6	10 μF	50V	Ceramic
R3	22kΩ	ROHM	MCR18EZPF2202	C7-9	1μF	50V	Ceramic
R4	100kΩ	ROHM	MCR18EZPF1003	C10	0.1μF	50V	Ceramic
R5	100kΩ	ROHM	MCR18EZPF1003	C11	1μF	50V	Ceramic
R6	0.5Ω	ROHM	MCR50JZHFL1R50 // 3	C12	100pF	50V	Ceramic
R7	10kΩ	ROHM	MCR18EZPF1002	C13	0.1μF	630V	Ceramic
R8	0Ω	ROHM	MCR18EZPJ000	C14	0.1μF	50V	Ceramic
R9	0Ω	ROHM	MCR18EZPJ000	HX	-	-	Hall elements
Q1	-	ROHM	DTC124EUA				
D1	-	ROHM	KDZ20B				

Interfaces

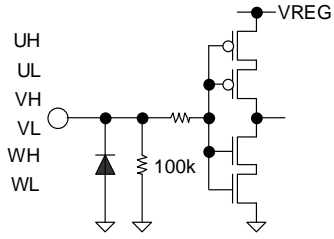

Figure 38. UH, UL, VH, VL, WH, WL

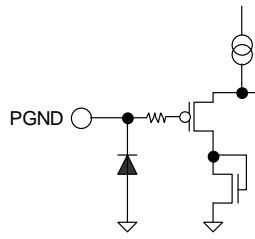

Figure 39. PGND

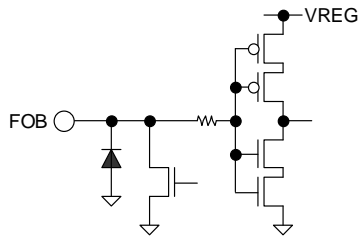

Figure 40. FOB

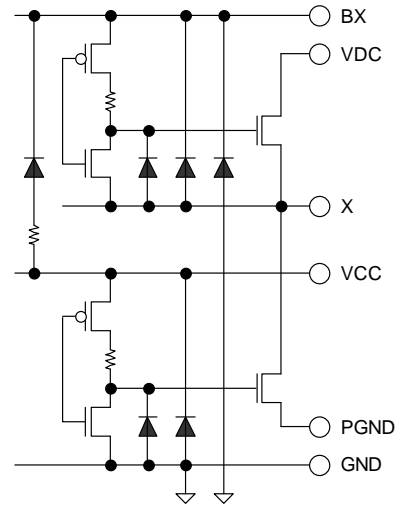

Figure 41. VCC, GND, VDC, BX(BU/BV/BW), X(U/V/W)



**Operational Notes****1. Reverse Connection of Power Supply**

Connecting the power supply in reverse polarity can damage the IC. Take precautions against reverse polarity when connecting the power supply, such as mounting an external diode between the power supply and the IC's power supply terminals.

**2. Power Supply Lines**

Design the PCB layout pattern to provide low impedance supply lines. Separate the ground and supply lines of the digital and analog blocks to prevent noise in the ground and supply lines of the digital block from affecting the analog block. Furthermore, connect a capacitor to ground at all power supply pins. Consider the effect of temperature and aging on the capacitance value when using electrolytic capacitors.

**3. Ground Voltage**

Ensure that no pins are at a voltage below that of the ground pin at any time, even during transient condition. However, pins that drive inductive loads (e.g. motor driver outputs, DC-DC converter outputs) may inevitably go below ground due to back EMF or electromotive force. In such cases, the user should make sure that such voltages going below ground will not cause the IC and the system to malfunction by examining carefully all relevant factors and conditions such as motor characteristics, supply voltage, operating frequency and PCB wiring to name a few.

**4. Ground Wiring Pattern**

When using both small-signal and large-current ground traces, the two ground traces should be routed separately but connected to a single ground at the reference point of the application board to avoid fluctuations in the small-signal ground caused by large currents. Also ensure that the ground traces of external components do not cause variations on the ground voltage. The ground lines must be as short and thick as possible to reduce line impedance.

**5. Thermal Consideration**

Should by any chance the power dissipation rating be exceeded the rise in temperature of the chip may result in deterioration of the properties of the chip. The absolute maximum rating of the Pd stated in this specification is when the IC is mounted on a 70mm x 70mm x 1.6mm glass epoxy board. In case of exceeding this absolute maximum rating, increase the board size and copper area to prevent exceeding the Pd rating.

**6. Recommended Operating Conditions**

These conditions represent a range within which the expected characteristics of the IC can be approximately obtained. The electrical characteristics are guaranteed under the conditions of each parameter.

**7. Rush Current**

When power is first supplied to the IC, it is possible that the internal logic may be unstable and inrush current may flow instantaneously due to the internal powering sequence and delays, especially if the IC has more than one power supply. Therefore, give special consideration to power coupling capacitance, power wiring, width of ground wiring, and routing of connections.

**8. Operation Under Strong Electromagnetic Field**

Operating the IC in the presence of a strong electromagnetic field may cause the IC to malfunction.

**9. Testing on Application Boards**

When testing the IC on an application board, connecting a capacitor directly to a low-impedance output pin may subject the IC to stress. Always discharge capacitors completely after each process or step. The IC's power supply should always be turned off completely before connecting or removing it from the test setup during the inspection process. To prevent damage from static discharge, ground the IC during assembly and use similar precautions during transport and storage.

**10. Inter-pin Short and Mounting Errors**

Ensure that the direction and position are correct when mounting the IC on the PCB. Incorrect mounting may result in damaging the IC. Avoid nearby pins being shorted to each other especially to ground, power supply and output pin. Inter-pin shorts could be due to many reasons such as metal particles, water droplets (in very humid environment) and unintentional solder bridge deposited in between pins during assembly to name a few.

**11. Unused Input Pins**

Input pins of an IC are often connected to the gate of a MOS transistor. The gate has extremely high impedance and extremely low capacitance. If left unconnected, the electric field from the outside can easily charge it. The small charge acquired in this way is enough to produce a significant effect on the conduction through the transistor and cause unexpected operation of the IC. So unless otherwise specified, unused input pins should be connected to the power supply or ground line.

**12. Regarding the Input Pin of the IC**

Do not force voltage to the input pins when the power does not supply to the IC. Also, do not force voltage to the input pins that exceed the supply voltage or in the guaranteed the absolute maximum rating value even if the power is supplied to the IC.

When using this IC, the high voltage pins VDC, BU/U, BV/V and BW/W need a resin coating between these pins. It is judged that the inter-pins distance is not enough. If any special mode in excess of absolute maximum ratings is to be implemented with this product or its application circuits, it is important to take physical safety measures, such as providing voltage-clamping diodes or fuses. And, set the output transistor so that it does not exceed absolute maximum ratings or ASO. In the event a large capacitor is connected between the output and ground, and if VCC and VDC are short-circuited with 0V or ground for any reason, the current charged in the capacitor flows into the output and may destroy the IC.

**13. Ceramic Capacitor**

When using a ceramic capacitor, determine the dielectric constant considering the change of capacitance with temperature and the decrease in nominal capacitance due to DC bias and others.

**14. Area of Safe Operation (ASO)**

Operate the IC such that the output voltage, output current, and power dissipation are all within the Area of Safe Operation (ASO).

Physical Dimension, Tape and Reel Information

<b>Package Name</b>	<b>SSOP-A54_23</b>
---------------------	--------------------

(UNIT : mm)  
PKG : SSOP-A54\_23

**<Tape and Reel information>**

<b>Tape</b>	Embossed carrier tape
<b>Quantity</b>	1000pcs
<b>Direction of feed</b>	E2 ( The direction is the 1pin of product is at the upper left when you hold reel on the left hand and you pull out the tape on the right hand )

  

\*Order quantity needs to be multiple of the minimum quantity.

Ordering Information

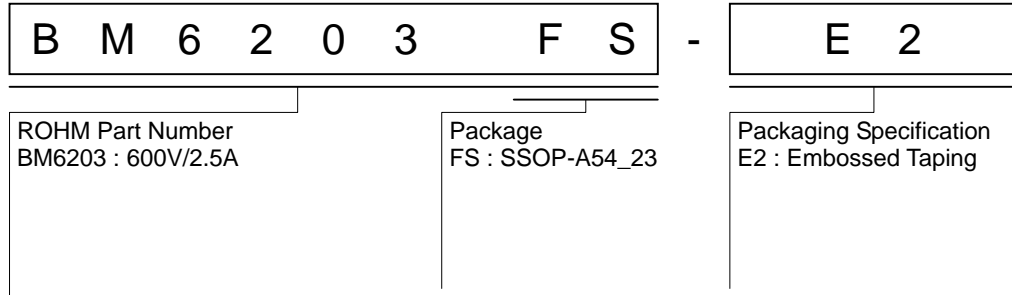

Marking Diagram

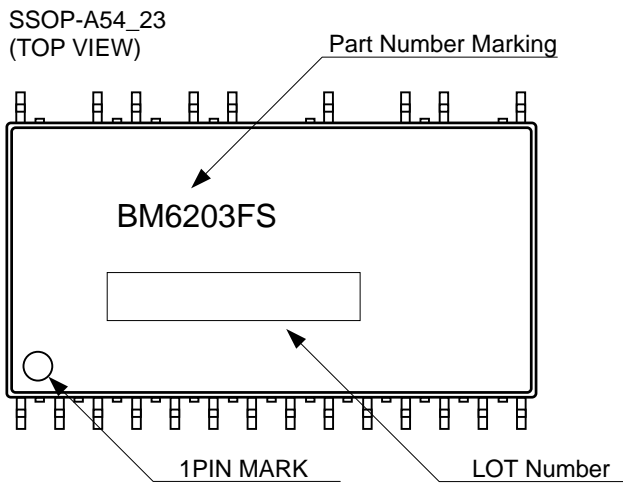

Revision History

Date	Revision	Changes
25.JUL.2013	001	New release

# Notice

## Precaution on using ROHM Products

- Our Products are designed and manufactured for application in ordinary electronic equipments (such as AV equipment, OA equipment, telecommunication equipment, home electronic appliances, amusement equipment, etc.). If you intend to use our Products in devices requiring extremely high reliability (such as medical equipment <sup>(Note 1)</sup>, transport equipment, traffic equipment, aircraft/spacecraft, nuclear power controllers, fuel controllers, car equipment including car accessories, safety devices, etc.) and whose malfunction or failure may cause loss of human life, bodily injury or serious damage to property ("Specific Applications"), please consult with the ROHM sales representative in advance. Unless otherwise agreed in writing by ROHM in advance, ROHM shall not be in any way responsible or liable for any damages, expenses or losses incurred by you or third parties arising from the use of any ROHM's Products for Specific Applications.

(Note1) Medical Equipment Classification of the Specific Applications

JAPAN	USA	EU	CHINA
CLASS III	CLASS III	CLASS II b	CLASS III
CLASS IV		CLASS III	

- ROHM designs and manufactures its Products subject to strict quality control system. However, semiconductor products can fail or malfunction at a certain rate. Please be sure to implement, at your own responsibilities, adequate safety measures including but not limited to fail-safe design against the physical injury, damage to any property, which a failure or malfunction of our Products may cause. The following are examples of safety measures:
  - Installation of protection circuits or other protective devices to improve system safety
  - Installation of redundant circuits to reduce the impact of single or multiple circuit failure
- Our Products are designed and manufactured for use under standard conditions and not under any special or extraordinary environments or conditions, as exemplified below. Accordingly, ROHM shall not be in any way responsible or liable for any damages, expenses or losses arising from the use of any ROHM's Products under any special or extraordinary environments or conditions. If you intend to use our Products under any special or extraordinary environments or conditions (as exemplified below), your independent verification and confirmation of product performance, reliability, etc. prior to use, must be necessary:
  - Use of our Products in any types of liquid, including water, oils, chemicals, and organic solvents
  - Use of our Products outdoors or in places where the Products are exposed to direct sunlight or dust
  - Use of our Products in places where the Products are exposed to sea wind or corrosive gases, including Cl<sub>2</sub>, H<sub>2</sub>S, NH<sub>3</sub>, SO<sub>2</sub>, and NO<sub>2</sub>
  - Use of our Products in places where the Products are exposed to static electricity or electromagnetic waves
  - Use of our Products in proximity to heat-producing components, plastic cords, or other flammable items
  - Sealing or coating our Products with resin or other coating materials
  - Use of our Products without cleaning residue of flux (even if you use no-clean type fluxes, cleaning residue of flux is recommended); or Washing our Products by using water or water-soluble cleaning agents for cleaning residue after soldering
  - Use of the Products in places subject to dew condensation
- The Products are not subject to radiation-proof design.
- Please verify and confirm characteristics of the final or mounted products in using the Products.
- In particular, if a transient load (a large amount of load applied in a short period of time, such as pulse. is applied, confirmation of performance characteristics after on-board mounting is strongly recommended. Avoid applying power exceeding normal rated power; exceeding the power rating under steady-state loading condition may negatively affect product performance and reliability.
- De-rate Power Dissipation (Pd) depending on Ambient temperature (Ta). When used in sealed area, confirm the actual ambient temperature.
- Confirm that operation temperature is within the specified range described in the product specification.
- ROHM shall not be in any way responsible or liable for failure induced under deviant condition from what is defined in this document.

## Precaution for Mounting / Circuit board design

- When a highly active halogenous (chlorine, bromine, etc.) flux is used, the residue of flux may negatively affect product performance and reliability.
- In principle, the reflow soldering method must be used; if flow soldering method is preferred, please consult with the ROHM representative in advance.

For details, please refer to ROHM Mounting specification

### Precautions Regarding Application Examples and External Circuits

1. If change is made to the constant of an external circuit, please allow a sufficient margin considering variations of the characteristics of the Products and external components, including transient characteristics, as well as static characteristics.
2. You agree that application notes, reference designs, and associated data and information contained in this document are presented only as guidance for Products use. Therefore, in case you use such information, you are solely responsible for it and you must exercise your own independent verification and judgment in the use of such information contained in this document. ROHM shall not be in any way responsible or liable for any damages, expenses or losses incurred by you or third parties arising from the use of such information.

### Precaution for Electrostatic

This Product is electrostatic sensitive product, which may be damaged due to electrostatic discharge. Please take proper caution in your manufacturing process and storage so that voltage exceeding the Products maximum rating will not be applied to Products. Please take special care under dry condition (e.g. Grounding of human body / equipment / solder iron, isolation from charged objects, setting of Ionizer, friction prevention and temperature / humidity control).

### Precaution for Storage / Transportation

1. Product performance and soldered connections may deteriorate if the Products are stored in the places where:
  - [a] the Products are exposed to sea winds or corrosive gases, including Cl<sub>2</sub>, H<sub>2</sub>S, NH<sub>3</sub>, SO<sub>2</sub>, and NO<sub>2</sub>
  - [b] the temperature or humidity exceeds those recommended by ROHM
  - [c] the Products are exposed to direct sunshine or condensation
  - [d] the Products are exposed to high Electrostatic
2. Even under ROHM recommended storage condition, solderability of products out of recommended storage time period may be degraded. It is strongly recommended to confirm solderability before using Products of which storage time is exceeding the recommended storage time period.
3. Store / transport cartons in the correct direction, which is indicated on a carton with a symbol. Otherwise bent leads may occur due to excessive stress applied when dropping of a carton.
4. Use Products within the specified time after opening a humidity barrier bag. Baking is required before using Products of which storage time is exceeding the recommended storage time period.

### Precaution for Product Label

QR code printed on ROHM Products label is for ROHM's internal use only.

### Precaution for Disposition

When disposing Products please dispose them properly using an authorized industry waste company.

### Precaution for Foreign Exchange and Foreign Trade act

Since our Products might fall under controlled goods prescribed by the applicable foreign exchange and foreign trade act, please consult with ROHM representative in case of export.

### Precaution Regarding Intellectual Property Rights

1. All information and data including but not limited to application example contained in this document is for reference only. ROHM does not warrant that foregoing information or data will not infringe any intellectual property rights or any other rights of any third party regarding such information or data. ROHM shall not be in any way responsible or liable for infringement of any intellectual property rights or other damages arising from use of such information or data.:
2. No license, expressly or implied, is granted hereby under any intellectual property rights or other rights of ROHM or any third parties with respect to the information contained in this document.

### Other Precaution

1. This document may not be reprinted or reproduced, in whole or in part, without prior written consent of ROHM.
2. The Products may not be disassembled, converted, modified, reproduced or otherwise changed without prior written consent of ROHM.
3. In no event shall you use in any way whatsoever the Products and the related technical information contained in the Products or this document for any military purposes, including but not limited to, the development of mass-destruction weapons.
4. The proper names of companies or products described in this document are trademarks or registered trademarks of ROHM, its affiliated companies or third parties.

**General Precaution**

1. Before you use our Products, you are requested to carefully read this document and fully understand its contents. ROHM shall not be in any way responsible or liable for failure, malfunction or accident arising from the use of any ROHM's Products against warning, caution or note contained in this document.
2. All information contained in this document is current as of the issuing date and subject to change without any prior notice. Before purchasing or using ROHM's Products, please confirm the latest information with a ROHM sales representative.
3. The information contained in this document is provided on an "as is" basis and ROHM does not warrant that all information contained in this document is accurate and/or error-free. ROHM shall not be in any way responsible or liable for any damages, expenses or losses incurred by you or third parties resulting from inaccuracy or errors of or concerning such information.