



SOT-25



Pin Definition:

1. SW
2. Ground
3. FB
4. EN
5. Input

General Description

The TS1935B is a current mode step up converter intended for small, low power applications. The converter input voltage ranging from 2.6V to 5.5V. The Output voltage can be set up to 27V. The frequency is 1.2MHz allows the use of small external inductors and capacitors and provides fast transient response. Internal soft start results in small inrush current and extends battery life. Internal power MOSFET with very low RDS (ON) provides high efficiency. The TS1935B automatically transits from PWM to PFM during light load condition further increasing efficiency. The converter also provides protection functions such as under-voltage lockout, current limit and thermal shutdown.

Features

- 2.6V to 5.5 V operating input voltage range
- Adjustable output voltage range up to 27V
- 1.2MHz Fixed Switching Frequency
- Internal soft-start function
- Current limit and Thermal shutdown protection
- Under voltage Lockout
- $\leq 1\mu\text{A}$ Shutdown Current

Application

- White LED Current Source
- Digital Still Cameras
- Portable Electronics
- PDA's and Palm-Top Computers
- Local Boost Regulator

Ordering Information

Part No.	Package	Packing
TS1935BCX5 RFG	SOT-25	3Kpcs / 7" Reel

Note: "G" denotes for Halogen Free

Absolute Maximum Rating

Parameter	Symbol	Limit	Unit
Input Voltage	V_{IN}	GND - 0.3 to GND + 6.5	V
EN, V_{FB} Voltage	V_{EN}, V_{FB}	GND - 0.3 to $V_{CC} + 0.3$	V
SW Voltage	V_{SW}	30	V
Ambient Temperature Range	T_A	-40 to +85	$^{\circ}\text{C}$
Junction Temperature Range	T_J	-40 to +125	$^{\circ}\text{C}$
Storage Temperature Range	T_{STG}	-40 to +150	$^{\circ}\text{C}$

Note: Stress above the listed absolute maximum rating may cause permanent damage to the device

Thermal Information

Parameter	Symbol	Maximum	Unit
Thermal Resistance* (Junction to Case)	Θ_{JC}	110	$^{\circ}\text{C}/\text{W}$
Thermal Resistance* (Junction to Ambient)	Θ_{JA}	250	$^{\circ}\text{C}/\text{W}$
Internal Power Dissipation	P_D	$(T_J - T_A) / \Theta_{JA}$	mW
Maximum Junction Temperature	T_J	150	$^{\circ}\text{C}$
Lead Solder Temperature (260 $^{\circ}\text{C}$)		5	S

Note: Θ_{JA} is measured with the PCB copper area of approximately 1 in²(Multi-layer).

Electrical Specifications (Ta = 25°C, VIN=5V, EN=VIN, IL=0A unless otherwise noted)

Characteristics	Symbol	Conditions	Min	Typ	Max	Units
Input Voltage range	V _{CC}		2.6	--	5.5	V
Under Voltage Lockout	UVLO	Rising	--	2.35	2.60	V
UVLO Hysteresis			--	-130	--	mV
Step-Up Voltage Adjust Range	V _{OUT}		3	--	27	V
Operating quiescent current	I _{CCQ}	I _{OUT} = 0mA, V _{FB} =1.5V	--	150	250	μA
Shutdown current	I _{SD}	V _{EN} =0V	--	0.1	1	μA
Feedback Voltage	V _{FB}		1.213	1.238	1.263	V
FB Input Leakage Current	I _{FB-LKG}	V _{FB} = 1.3V	-100	0.01	+100	nA
Line Regulation		V _{IN} = 2.5 to 5.5V I _{OUT} = 20mA	--	0.2	--	%
Load Regulation		V _{IN} = 5V I _{OUT} = 1mA to 400mA	-	0.2	--	%
Switching frequency	F _{OSC}		900	1200	1500	KHz
Maximum Duty	D _{MAX}		82	87	-	%
N-channel MOSFET current limit	I _{LIM}	Duty=50%	--	1.9	--	A
MOSFET on-resistance (Note 1)	R _{DS(on)}	V _{CC} =3V, I _{SW} =1A	--	650	-	mΩ
		V _{CC} =5V, I _{SW} =1A	--	500	--	
SW Leakage Current	I _{SWL}	V _{LX} = 27V, V _{FB} =1.5V	--	--	1	μA
EN high-level input voltage	V _{IH}		1.0	--	--	V
EN low-level input voltage	V _{IL}		--	--	0.4	V
EN Hysteresis	hys		--	200	-	mV
EN input leakage current	I _{EN-LKG}	V _{EN} =GND or V _{CC}	--	0.01	0.1	μA
Thermal Shutdown	T _{DS}		--	150	--	°C
Thermal Shutdown Hysteresis	T _{SH}		--	35	--	

Note 1: Guaranteed by design

Pin Description

Pin Number	Pin Name	Description
1	SW	Power Switch Output. SW is the drain of the internal MOSFET switch. Connect the power inductor and output rectifier to SW. SW can swing between GND and 27V.
2	GND	Ground. Tie directly to ground plan.
3	FB	Feedback Input. FB voltage is 1.238V. Connect a resistor divider to FB.
4	EN	Regulator On/Off Control Input. A high input at EN turns on the converter, and a low input turns it off. When not used, connect EN to the input source for automatic startup. The EN pin cannot be left floating.
5	VCC	Input Supply Pin. Must be locally bypassed.

Block Diagram

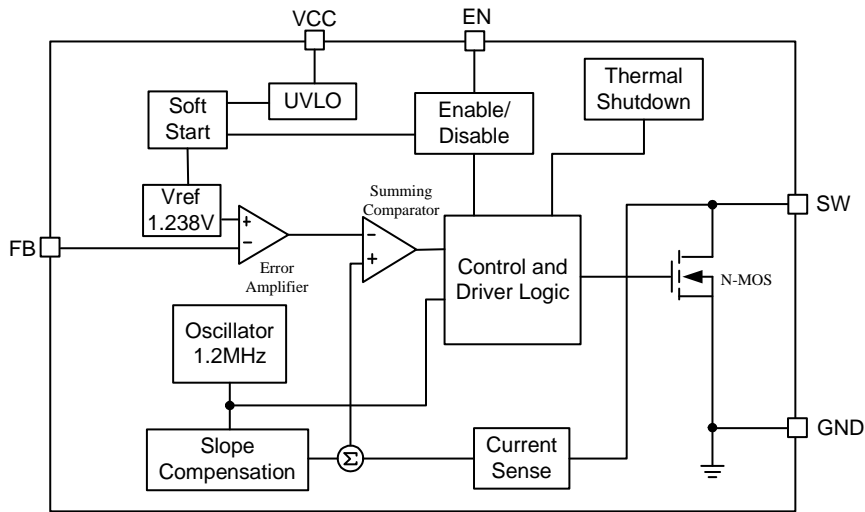

Application Circuit

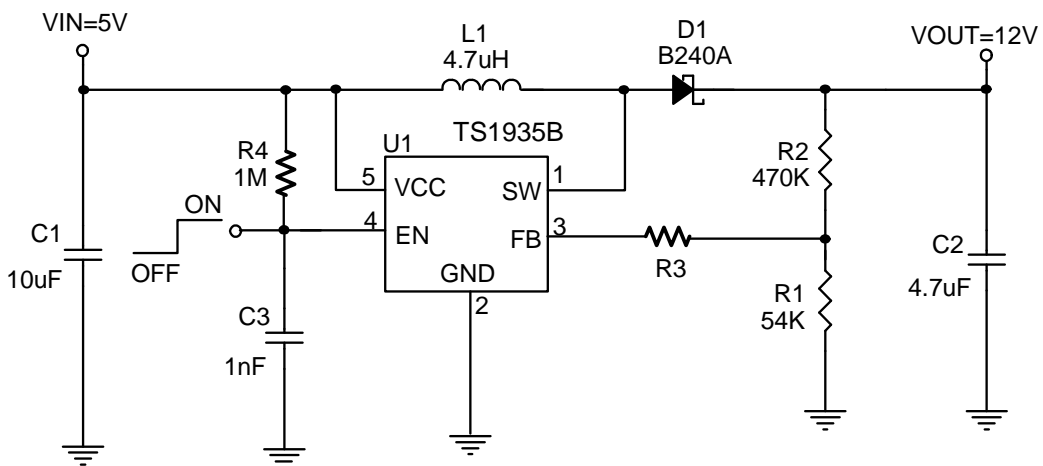

$$V_{OUT} = 1.238V \times \left(1 + \frac{R2}{R1}\right)$$

R2 Suggest 390K~820K

VIN	VOUT	R3
2.6~3.6V	5V	120KΩ
2.6~5.3V	7V	82KΩ
2.6~5.5V	7.5~27V	0Ω

Application Information

Setting the Output Voltage

Application circuit item shows the basic application circuit with AX5511 adjustable output version. The external resistor sets the output voltage according to the following equation:

$$V_{OUT} = 1.238V \times \left(1 + \frac{R2}{R1}\right)$$

For most applications, R2 is a suggested a value by 390K~820KΩ. Place the resistor-divider as close to the IC as possible to reduce the noise sensitivity.

Under Voltage Lockout (UVLO)

To avoid mis-operation of the device at low input voltages an under voltage lockout is included that disables the device, if the input voltage falls below (2.35V-130mV).

Input Capacitor Selection

The input capacitor reduces the surge current drawn from the input and switching noise from the device. The input capacitor impedance at the switching frequency shall be less than input source impedance to prevent high frequency switching current passing to the input. A low ESR input capacitor sized for maximum RMS current must be used. Ceramic capacitors with X5R or X7R dielectrics are highly recommended because of their low ESR and small temperature coefficients. A 10μF ceramic capacitor for most applications is sufficient. For a lower output power requirement application, this value can be decreased.

Output Capacitor Selection

The output capacitor is required to keep the output voltage ripple small and to ensure regulation loop stability. The output capacitor must have low impedance at the switching frequency. Ceramic capacitors with X5R or X7R dielectrics are recommended due to their low ESR and high ripple current. A 4.7μF ceramic capacitors works for most of the applications. Higher capacitor values can be used to improve the load transient response.

Layout Guide

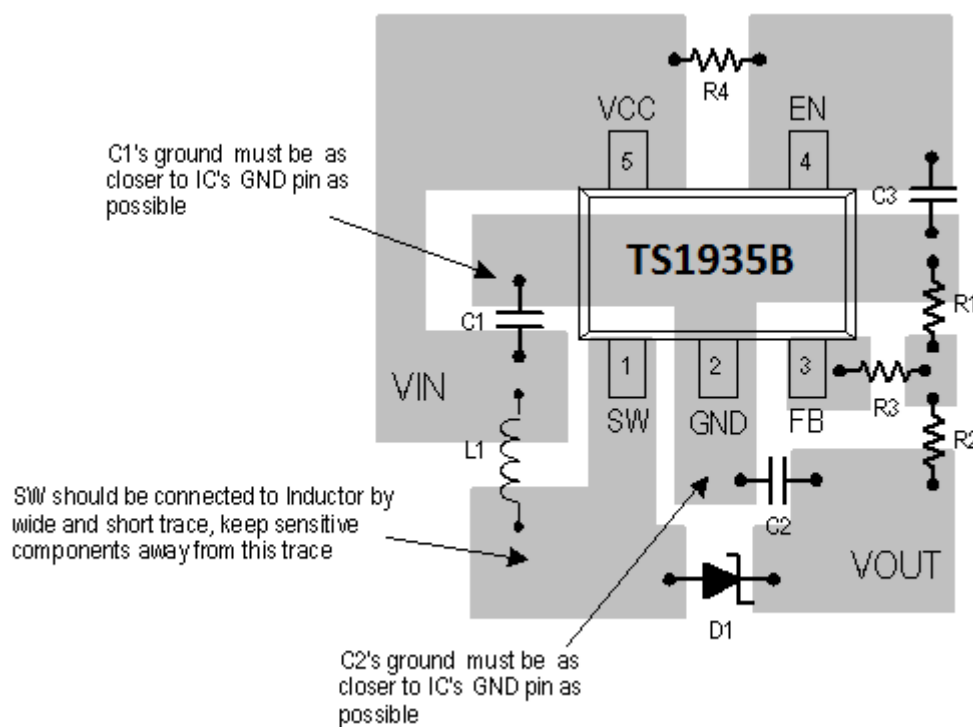



Electrical Characteristics Curve

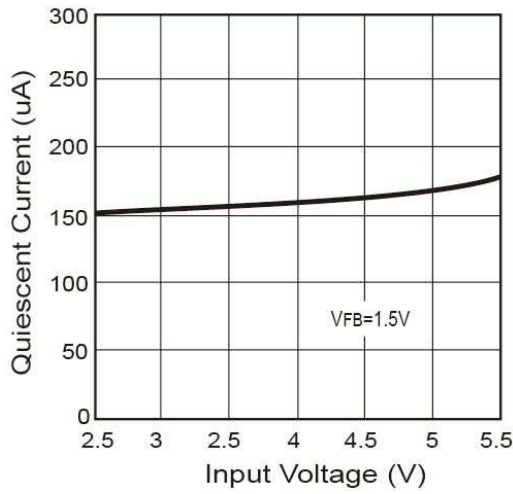

Figure 1. Quiescent Current vs. Input Voltage

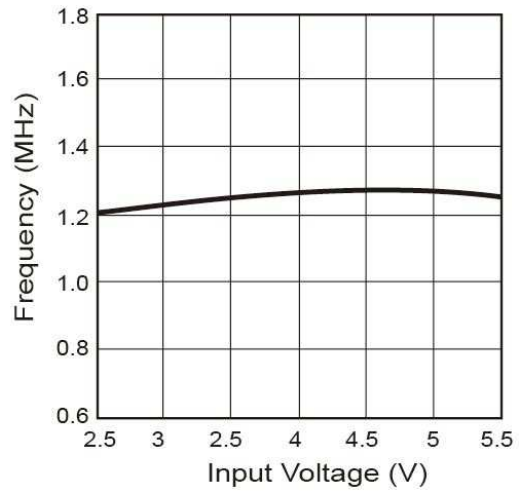

Figure 2. Frequency vs. Input Voltage

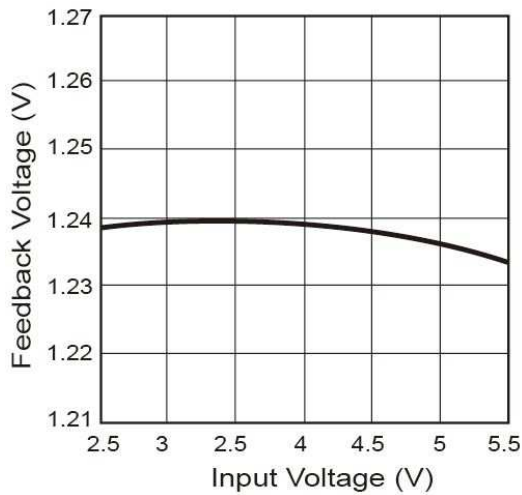

Figure 3. FB Voltage vs. Input Voltage

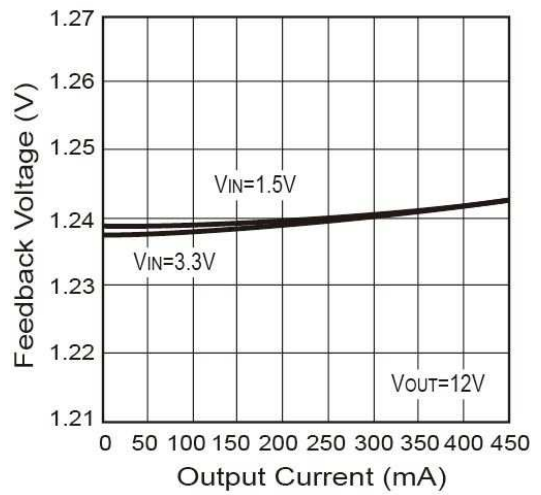

Figure 4. FB Voltage vs. Output Current

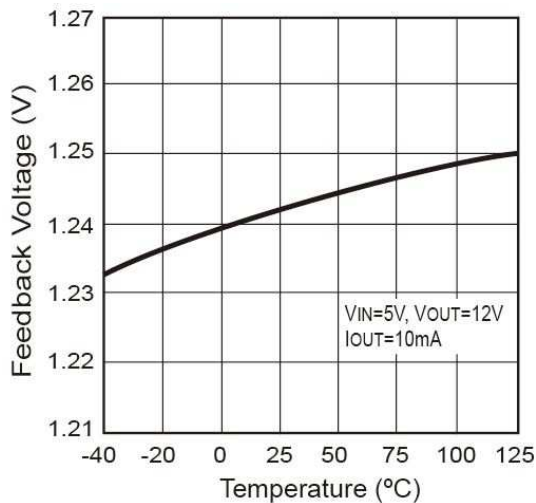

Figure 5. FB Voltage vs. Temperature

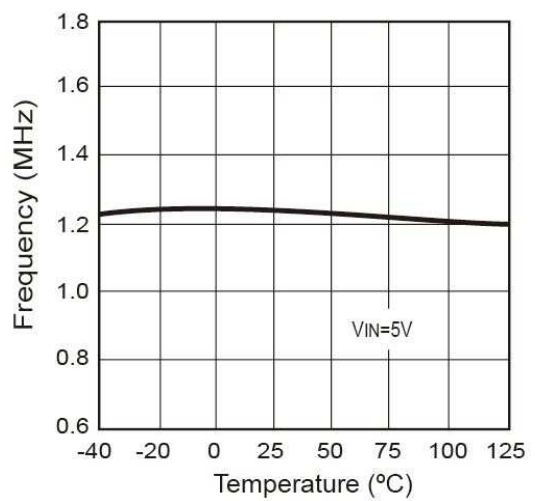

Figure 6. Frequency vs. Temperature

Electrical Characteristics Curve

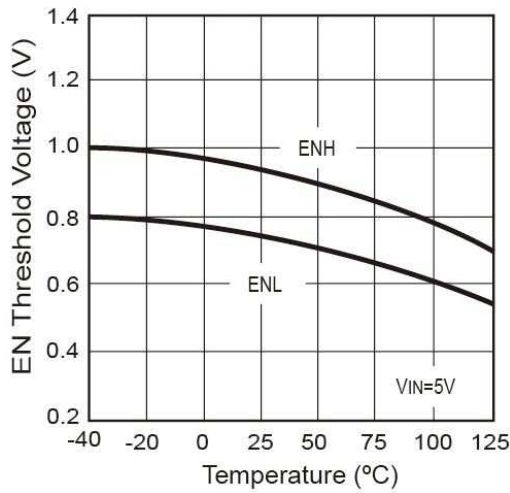

Figure 7. Threshold Voltage vs. Temperature

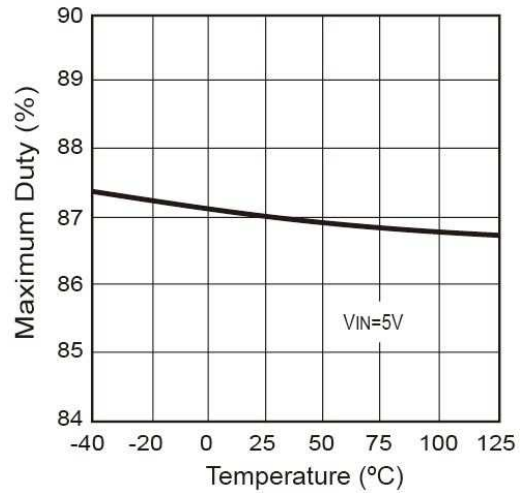

Figure 8. Max. Duty vs. Temperature

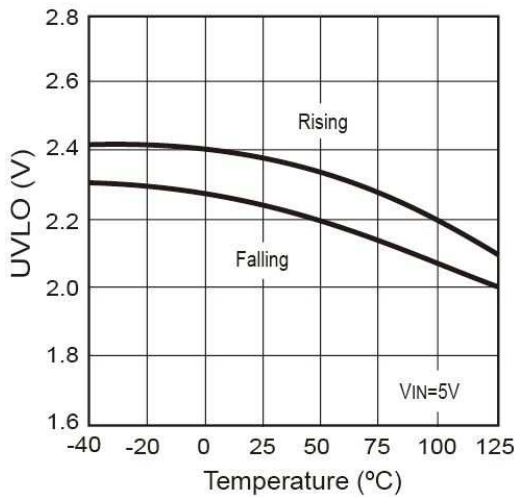

Figure 9. UVLO vs. Temperature

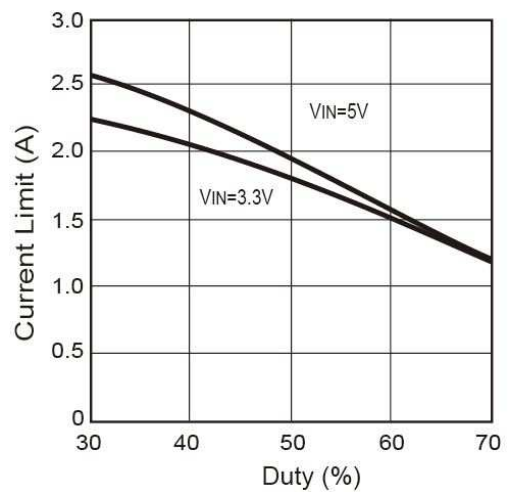

Figure 10. Duty vs. Current Limit

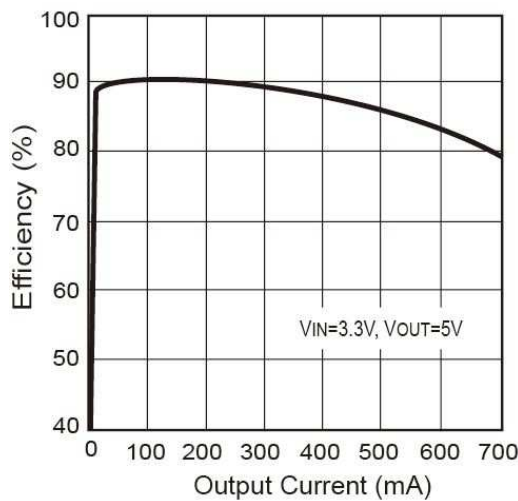

Figure 11. Efficiency vs. Output Current

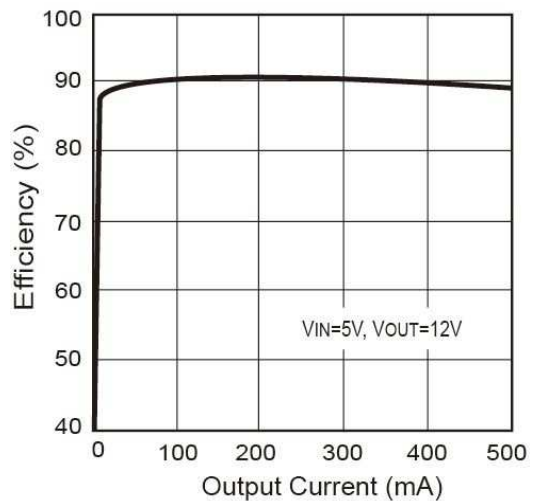
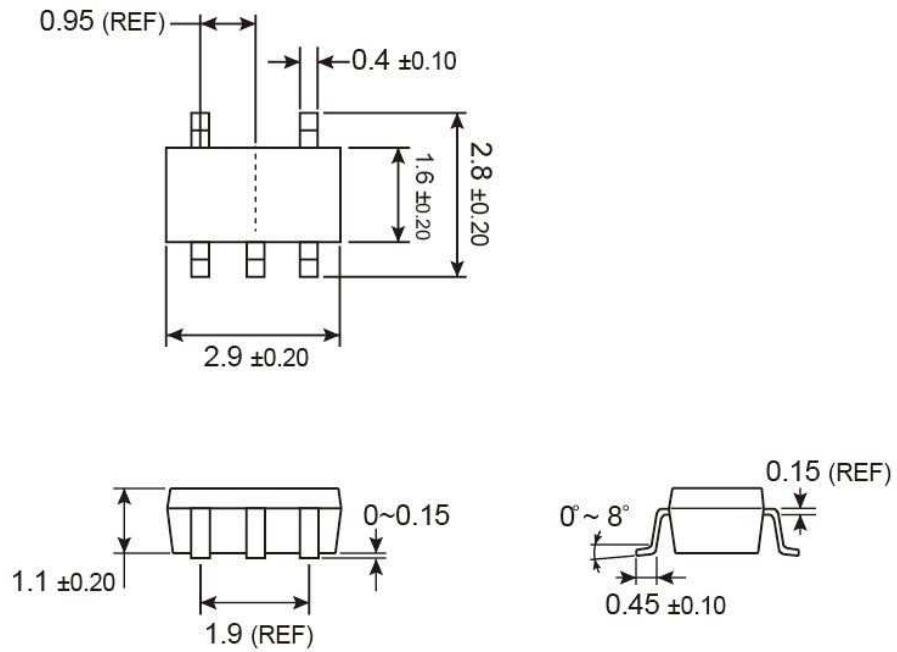

Figure 12. Efficiency vs. Output Current

SOT-25 Mechanical Drawing



Unit: Millimeters

Notice

Specifications of the products displayed herein are subject to change without notice. TSC or anyone on its behalf, assumes no responsibility or liability for any errors or inaccuracies.

Information contained herein is intended to provide a product description only. No license, express or implied, to any intellectual property rights is granted by this document. Except as provided in TSC's terms and conditions of sale for such products, TSC assumes no liability whatsoever, and disclaims any express or implied warranty, relating to sale and/or use of TSC products including liability or warranties relating to fitness for a particular purpose, merchantability, or infringement of any patent, copyright, or other intellectual property right.

The products shown herein are not designed for use in medical, life-saving, or life-sustaining applications. Customers using or selling these products for use in such applications do so at their own risk and agree to fully indemnify TSC for any damages resulting from such improper use or sale.