

# DIGITRON SEMICONDUCTORS

UES704-UES706

HIGH EFFICIENCY RECTIFIERS

## MAXIMUM RATINGS

Rating	Value
Peak Inverse Voltage: UES704	200V
Peak Inverse Voltage: UES705	300V
Peak Inverse Voltage: UES706	400V
Average D.C. Output Current, $I_o$ @ $T_c = 100^\circ\text{C}$	20A
Surge Current: 8.3mS	300A
Thermal Resistance Junction to Case:	1.5°C/W
Operating and Storage Temperature Range:	-55°C to +150°C

## ELECTRICAL SPECIFICATIONS

Part number	PIV	Maximum Forward Voltage		Maximum Reverse Current		Maximum Reverse Recovery Time*
		$T_c = 25^\circ\text{C}$	$T_c = 125^\circ\text{C}$	$T_c = 25^\circ\text{C}$	$T_c = 125^\circ\text{C}$	
UES704	200V	1.25V @ 20A $t_p = 300\mu\text{S}$	1.15V @ 20A $t_p = 300\mu\text{S}$	50 $\mu\text{A}$	10mA	50nS
UES705	300V					
UES706	400V					

Measured in circuit:  $I_F = 0.5\text{A}$ ,  $I_R = 1\text{A}$ ,  $I_{\text{REC}} = 0.25\text{A}$ .

## MECHANICAL CHARACTERISTICS

Case	DO-4(R)
Marking	Body painted, alpha-numeric
Normal polarity	Cathode is stud
Reverse polarity	Anode is stud (add "R" suffix)

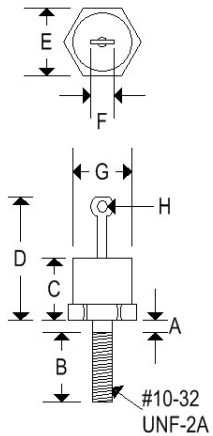

	DO-4(R)			
	Inches		Millimeters	
	Min	Max	Min	Max
A	-	0.078	-	1.981
B	0.422	0.453	10.719	11.506
C	-	0.405	-	10.287
D	-	0.800	-	20.320
E	0.420	0.440	10.668	11.176
F	-	0.250	-	6.350
G	-	0.424	-	10.770
H	0.066	-	1.676	-

Available Non-RoHS (standard) or RoHS compliant (add PBF suffix).

Available as "HR" (high reliability) screened per MIL-PRF-19500, JANTX level. Add "HR" suffix to base part number.

# DIGITRON SEMICONDUCTORS

UES704-UES706

HIGH EFFICIENCY RECTIFIERS

**Output Current vs. Case Temperature**

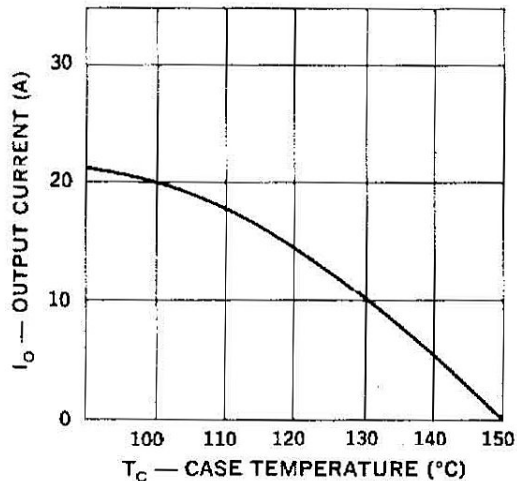

**Peak Output Current vs. Case Temperature**

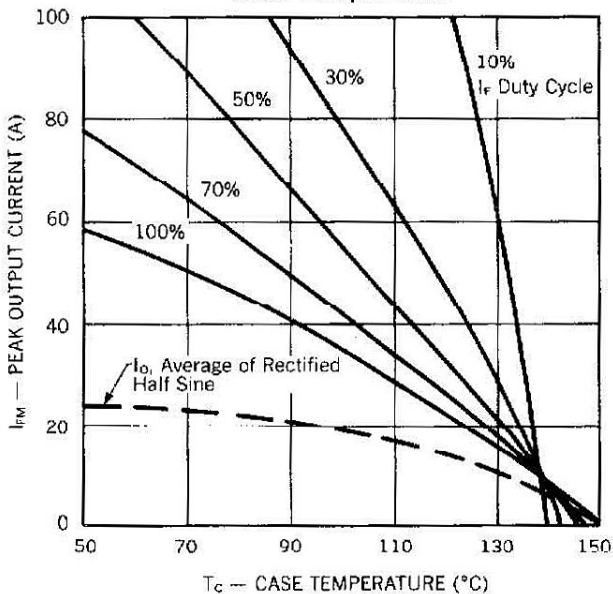

**Typical Forward Current vs. Forward Voltage**

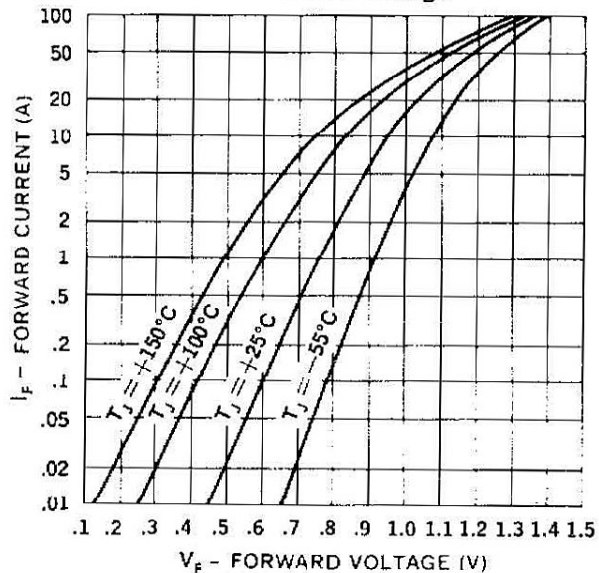

**Typical Reverse Current vs. Reverse Voltage**

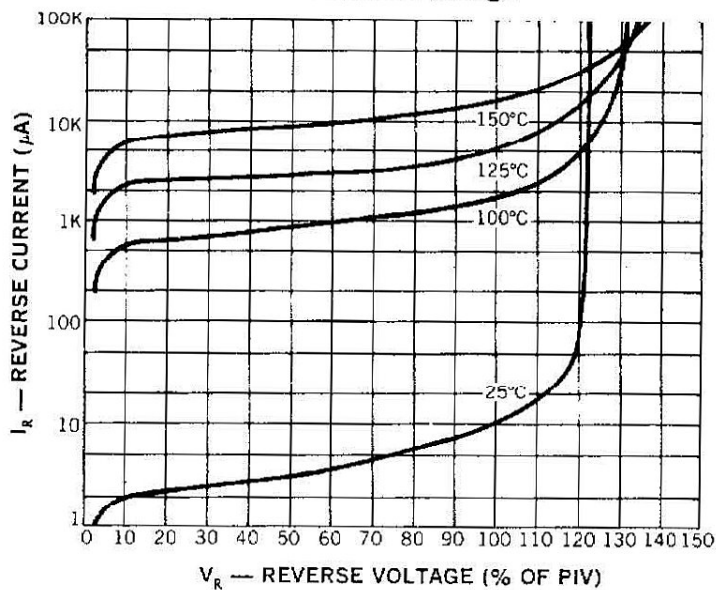

# DIGITRON SEMICONDUCTORS

UES704-UES706

HIGH EFFICIENCY RECTIFIERS

**Maximum Forward Surge vs. Number of Cycles**

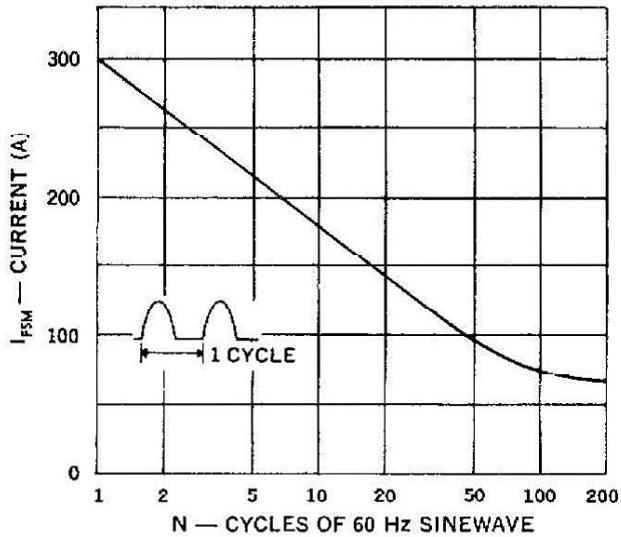

**Thermal Impedance vs. Pulse Width**

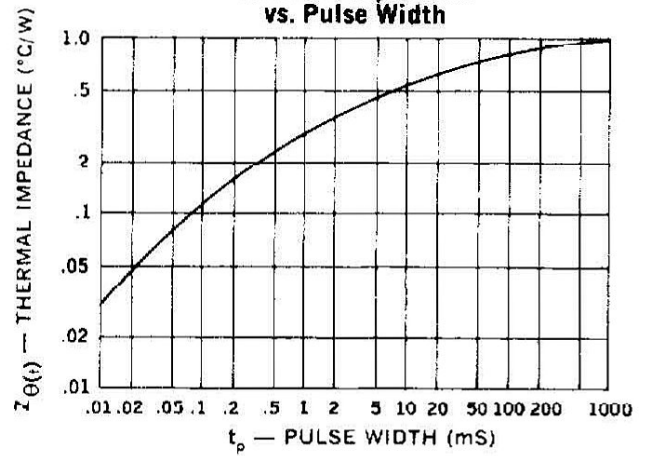

**Reverse-Recovery Circuit**

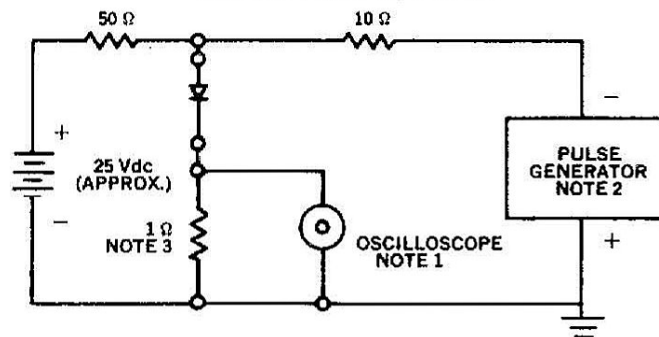

**NOTES:**

1. Oscilloscope: Rise time  $\leq 3\text{ns}$ ; input impedance = 50Ω.
2. Pulse Generator: Rise time  $< 8\text{ns}$ ; source impedance 10Ω.
3. Current viewing resistor, non-inductive, coaxial recommended.