

Features

- $S_{21} = 19.7 \text{ dB@380 MHz}$
= 18.3 dB@420 MHz
- NF fo 10.0 dB over Frequency
- Unconditionally Stable
- Single 5.4 V Supply
- High OIP3@Low Current

Description

APM0400-P33 is an internally matched amplifier mini-module for such application band in SMD package with the output P1dB of 33 dBm. It is compactly designed for low current consumption and high OIP3. Integrating all the components for biasing and matching within the module enhances production yield and throughput as well. It passes through the stringent DC, RF, and reliability tests. Not sample test but 100% quality control test is made before packing.

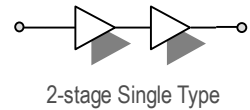

Specifications (in Production)

Typ. @T = 25 °C, $V_s = 5.4 \text{ V}$, Freq. = 400 MHz, $Z_{o,sys} = 50 \text{ ohms}$

Parameter	Unit	Specifications		
		Min	Typ	Max
Frequency Range	MHz	380		420
Gain	dB	18	19	
Gain Flatness	dB		± 0.7	± 0.8
Noise Figure	dB		10	11
Output IP3 ⁽¹⁾	dBm	44	47	
S11/S22 ⁽²⁾	dB			-10/-12
Output P1dB	dBm	32	33	
Switching Time ⁽³⁾	μsec		-	
Supply Current	mA		600	700
Supply Voltage	V		5.4	
Impedance	Ω		50	
Max. RF Input Power	dBm	C.W 23 ~ 25 (before fail)		
Package Type & Size	mm	Surface Mount Type, 13Wx13Lx3.8H		

Operating temperature is $-40 \text{ }^\circ\text{C}$ to $+85 \text{ }^\circ\text{C}$.

1) OIP3 is measured with two tones at an output power of 18 dBm/ tone separated by 1 MHz.

2) S11, S22 (max) is the worst value within the frequency band.

3) Switching time means the time that takes for output power to get stabilized to its final level after switching DC voltage from 0 V to V_s .

More Information

Website: www.asb.co.kr
E-mail: sales@asb.co.kr

Tel: (82) 42-528-7223
Fax: (82) 42-528-7222

ASB Inc., 4th Fl. Venture Town
Bldg., 367-17 Goijeong-Dong,
Seo-Gu, Daejeon 302-716, Korea

Outline Drawing (Unit: mm)

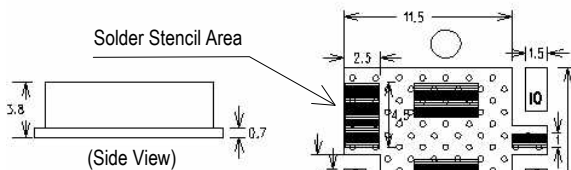
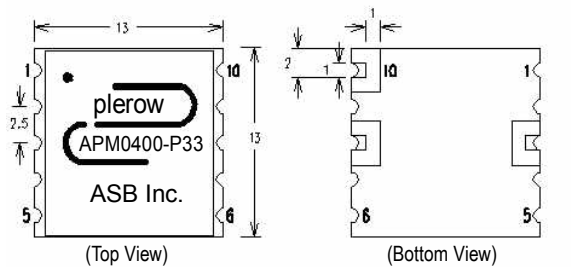

$\varnothing 0.3$ plated thru holes to ground plane

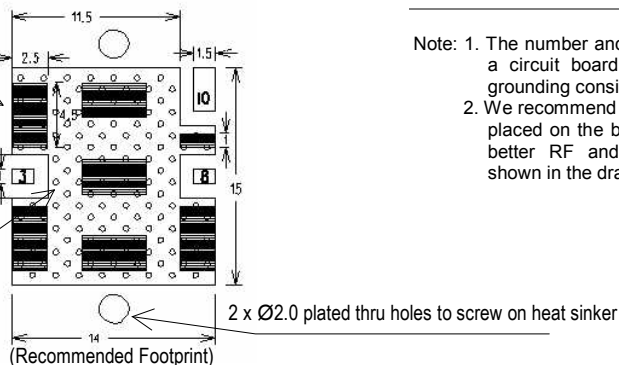

Pin Number	Function
3	RF In
8	RF Out
10	V_s
Others	Ground

Note: 1. The number and size of ground via holes in a circuit board is critical for thermal RF grounding considerations.

2. We recommend that the ground via holes be placed on the bottom of all ground pins for better RF and thermal performance, as shown in the drawing at the left side.

**Typical Performance
(Measured)**

380~420

+5.4 V

S-parameters

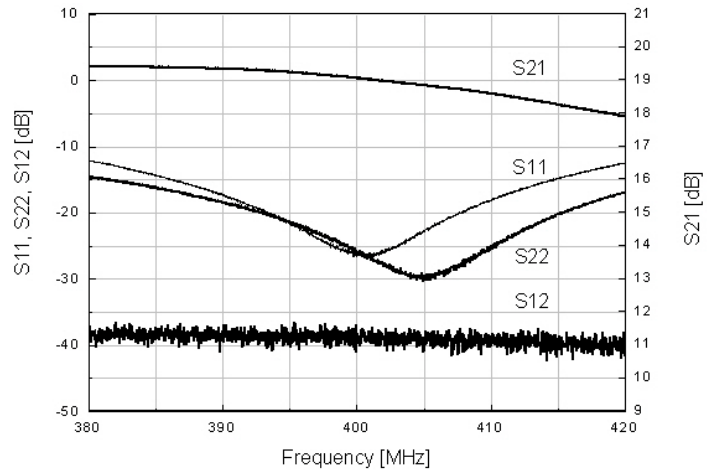

S-parameters & K Factor

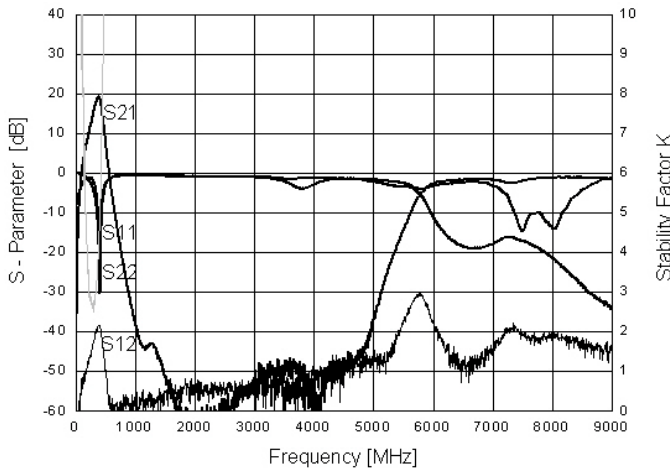

Noise Figure

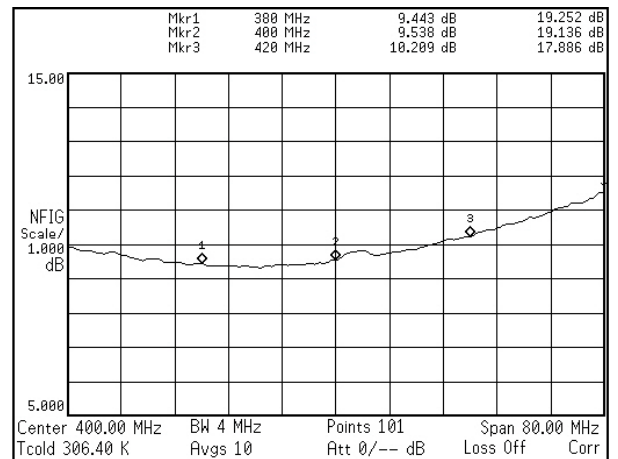

OIP3@380MHz

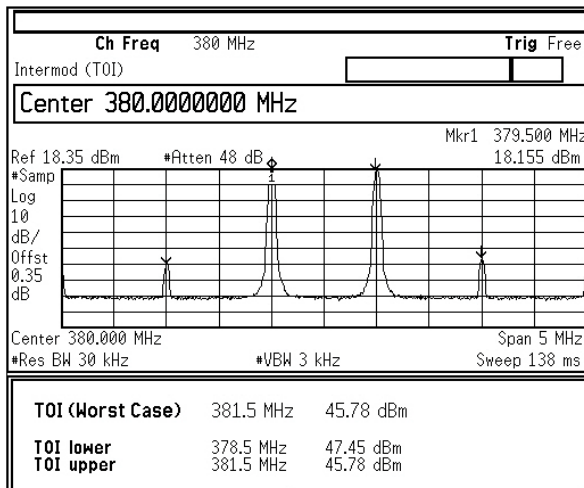

OIP3@400MHz

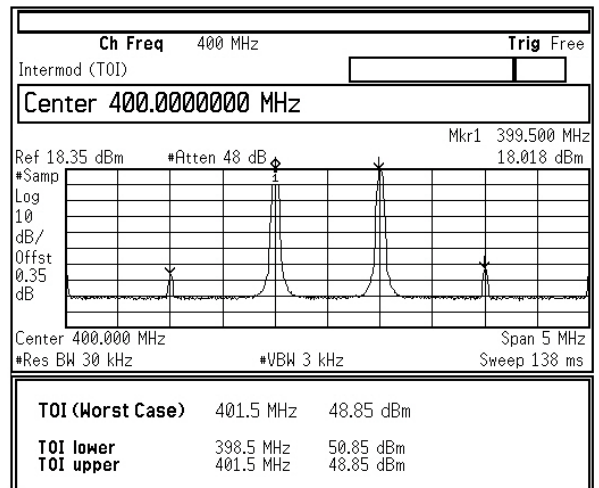

OIP3 @420MHz

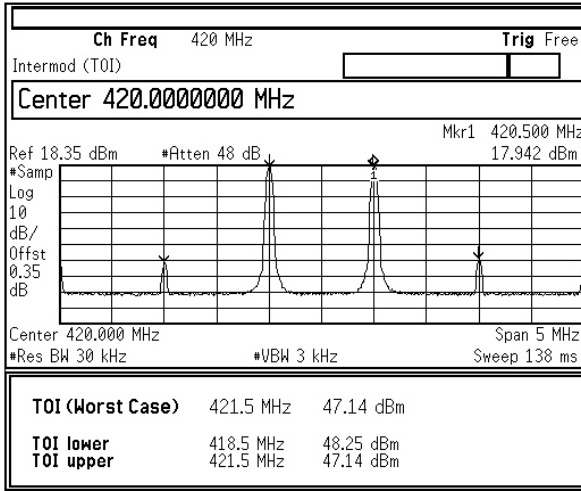

P1dB

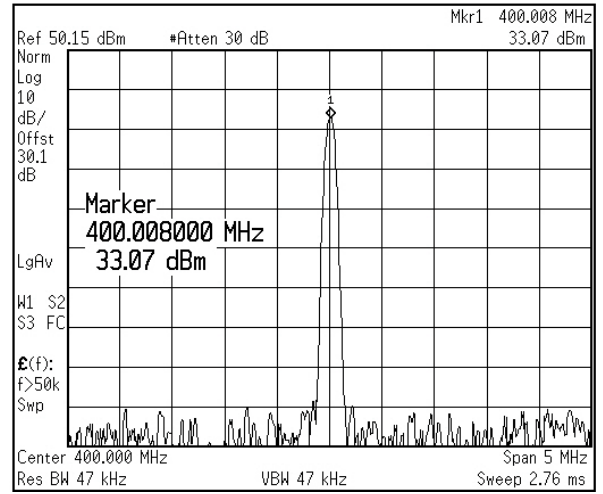

Pout vs Pin@400MHz

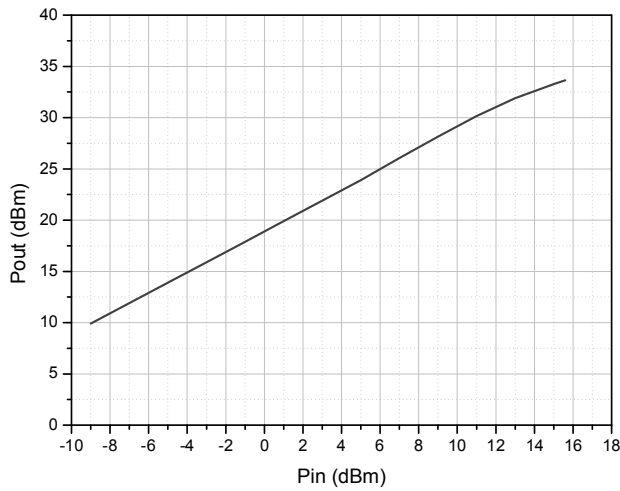

Current vs Pin@400MHz

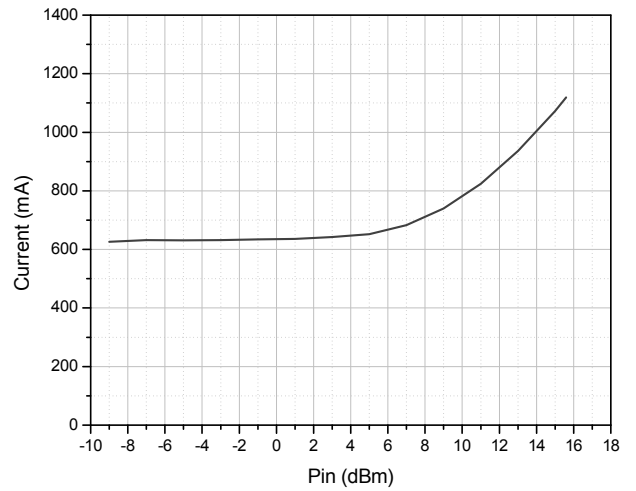

Application Circuit

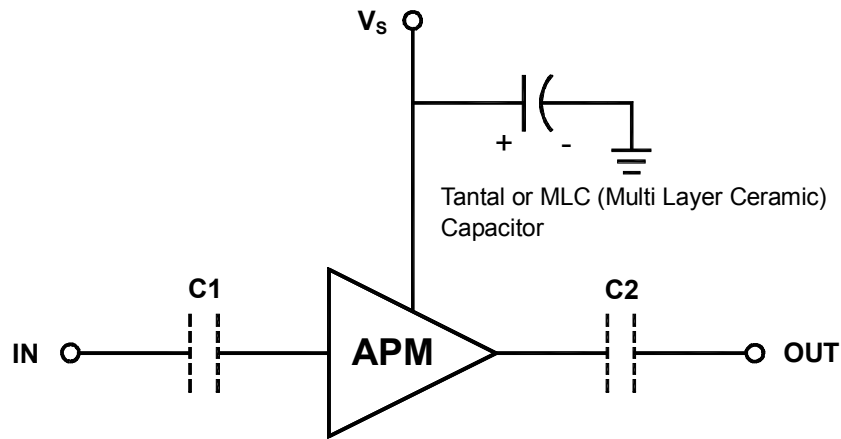

- 1) The tantalum or MLC (Multi Layer Ceramic) capacitor is optional and for bypassing the AC noise introduced from the DC supply. The capacitance value may be determined by customer's DC supply status. The capacitor should be placed as close as possible to V_s pin and be connected directly to the ground plane for the best electrical performance.
- 2) DC blocking capacitors are always necessarily placed at the input and output port for allowing only the RF signal to pass and blocking the DC component in the signal. The DC blocking capacitors are included inside the APM module. Therefore, C1 & C2 capacitors may not be necessary, but can be added just in case that the customer wants. The value of C1 & C2 is determined by considering the application frequency.

Recommended Soldering Reflow Process

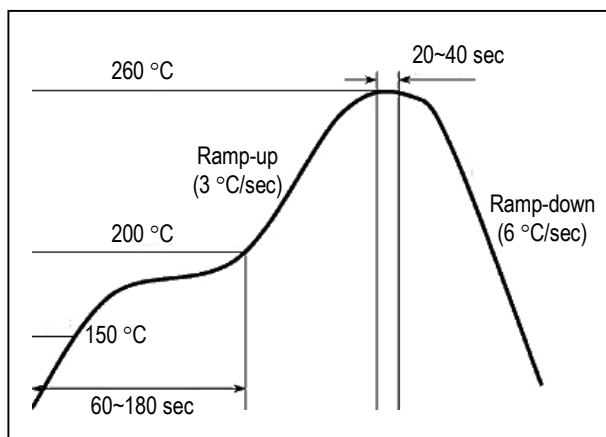

Evaluation Board Layout

