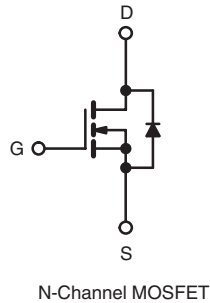
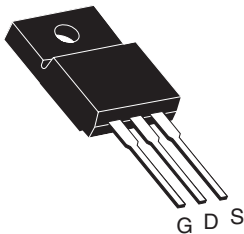

## Power MOSFET

PRODUCT SUMMARY		
$V_{DS}$ (V)	600	
$R_{DS(on)}$ ( $\Omega$ )	$V_{GS} = 10$ V	2.2
$Q_g$ (Max.) (nC)	31	
$Q_{gs}$ (nC)	4.6	
$Q_{gd}$ (nC)	17	
Configuration	Single	

**TO-220 FULLPAK**

### FEATURES

- Isolated Package
- High Voltage Isolation = 2.5 kV<sub>RMS</sub> (t = 60 s; f = 60 Hz)
- Sink to Lead Creepage Distance = 4.8 mm
- Dynamic dV/dt Rating
- Low Thermal Resistance
- Lead (Pb)-free Available

 Available  
**RoHS\***  
 COMPLIANT

### DESCRIPTION

Third generation Power MOSFETs from Vishay provide the designer with the best combination of fast switching, ruggedized device design, low on-resistance and cost-effectiveness.

The TO-220 FULLPAK eliminates the need for additional insulating hardware in commercial-industrial applications. The moulding compound used provides a high isolation capability and a low thermal resistance between the tab and external heatsink. This isolation is equivalent to using a 100 micron mica barrier with standard TO-220 product. The FULLPAK is mounted to a heatsink using a single clip or by a single screw fixing.

### ORDERING INFORMATION

Package	TO-220 FULLPAK
Lead (Pb)-free	IRFIBC30GPbF SiHFIBC30G-E3
SnPb	IRFIBC30G SiHFIBC30G

### ABSOLUTE MAXIMUM RATINGS $T_C = 25$ °C, unless otherwise noted

PARAMETER	SYMBOL	LIMIT	UNIT	
Drain-Source Voltage	$V_{DS}$	600	V	
Gate-Source Voltage	$V_{GS}$	$\pm 20$		
Continuous Drain Current	$V_{GS}$ at 10 V	$T_C = 25$ °C	2.5	A
		$T_C = 100$ °C	1.6	
Pulsed Drain Current <sup>a</sup>	$I_{DM}$	10		
Linear Derating Factor		0.28	W/°C	
Single Pulse Avalanche Energy <sup>b</sup>	$E_{AS}$	250	mJ	
Repetitive Avalanche Current <sup>a</sup>	$I_{AR}$	2.5	A	
Repetitive Avalanche Energy <sup>a</sup>	$E_{AR}$	3.5	mJ	
Maximum Power Dissipation	$T_C = 25$ °C	$P_D$	35	W
Peak Diode Recovery dV/dt <sup>c</sup>		dV/dt	3.0	V/ns
Operating Junction and Storage Temperature Range	$T_J, T_{stg}$		- 55 to + 150	°C
Soldering Recommendations (Peak Temperature)	for 10 s		300 <sup>d</sup>	
Mounting Torque	6-32 or M3 screw		10	
			1.1	N · m

#### Notes

- Repetitive rating; pulse width limited by maximum junction temperature (see fig. 11).
- $V_{DD} = 50$  V, starting  $T_J = 25$  °C, L = 73 mH,  $R_G = 25$   $\Omega$ ,  $I_{AS} = 2.5$  A (see fig. 12).
- $I_{SD} \leq 3.6$  A,  $dI/dt \leq 60$  A/ $\mu$ s,  $V_{DD} \leq V_{DS}$ ,  $T_J \leq 150$  °C.
- 1.6 mm from case.

\* Pb containing terminations are not RoHS compliant, exemptions may apply

THERMAL RESISTANCE RATINGS				
PARAMETER	SYMBOL	TYP.	MAX.	UNIT
Maximum Junction-to-Ambient	$R_{thJA}$	-	65	°C/W
Maximum Junction-to-Case (Drain)	$R_{thJC}$	-	3.6	

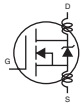
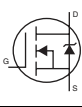
SPECIFICATIONS $T_J = 25\text{ }^\circ\text{C}$ , unless otherwise noted							
PARAMETER	SYMBOL	TEST CONDITIONS		MIN.	TYP.	MAX.	UNIT
<b>Static</b>							
Drain-Source Breakdown Voltage	$V_{DS}$	$V_{GS} = 0\text{ V}, I_D = 250\text{ }\mu\text{A}$		600	-	-	V
$V_{DS}$ Temperature Coefficient	$\Delta V_{DS}/T_J$	Reference to $25\text{ }^\circ\text{C}$ , $I_D = 1\text{ mA}$		-	0.62	-	V/°C
Gate-Source Threshold Voltage	$V_{GS(th)}$	$V_{DS} = V_{GS}, I_D = 250\text{ }\mu\text{A}$		2.0	-	4.0	V
Gate-Source Leakage	$I_{GSS}$	$V_{GS} = \pm 20\text{ V}$		-	-	$\pm 100$	nA
Zero Gate Voltage Drain Current	$I_{DSS}$	$V_{DS} = 600\text{ V}, V_{GS} = 0\text{ V}$		-	-	100	$\mu\text{A}$
		$V_{DS} = 480\text{ V}, V_{GS} = 0\text{ V}, T_J = 125\text{ }^\circ\text{C}$		-	-	500	
Drain-Source On-State Resistance	$R_{DS(on)}$	$V_{GS} = 10\text{ V}$	$I_D = 1.5\text{ A}^b$	-	-	2.2	$\Omega$
Forward Transconductance	$g_{fs}$	$V_{DS} = 50\text{ V}, I_D = 1.5\text{ A}^b$		2.2	-	-	S
<b>Dynamic</b>							
Input Capacitance	$C_{iss}$	$V_{GS} = 0\text{ V}, V_{DS} = 25\text{ V}, f = 1.0\text{ MHz}$ , see fig. 5		-	660	-	pF
Output Capacitance	$C_{oss}$			-	86	-	
Reverse Transfer Capacitance	$C_{riss}$			-	19	-	
Drain to Sink Capacitance	$C$	$f = 1.0\text{ MHz}$		-	12	-	
Total Gate Charge	$Q_g$	$V_{GS} = 10\text{ V}$	$I_D = 3.6\text{ A}, V_{DS} = 360\text{ V}$ , see fig. 6 and 13 <sup>b</sup>	-	-	31	nC
Gate-Source Charge	$Q_{GS}$			-	-	4.6	
Gate-Drain Charge	$Q_{GD}$			-	-	17	
Turn-On Delay Time	$t_{d(on)}$	$V_{DD} = 300\text{ V}, I_D = 3.6\text{ A}, R_G = 12\text{ }\Omega, R_D = 82\text{ }\Omega$ , see fig. 10 <sup>b</sup>		-	11	-	ns
Rise Time	$t_r$			-	13	-	
Turn-Off Delay Time	$t_{d(off)}$			-	35	-	
Fall Time	$t_f$			-	14	-	
Internal Drain Inductance	$L_D$	Between lead, 6 mm (0.25") from package and center of die contact 		-	4.5	-	nH
Internal Source Inductance	$L_S$			-	7.5	-	
<b>Drain-Source Body Diode Characteristics</b>							
Continuous Source-Drain Diode Current	$I_S$	MOSFET symbol showing the integral reverse p - n junction diode 		-	-	2.5	A
Pulsed Diode Forward Current <sup>a</sup>	$I_{SM}$			-	-	10	
Body Diode Voltage	$V_{SD}$	$T_J = 25\text{ }^\circ\text{C}, I_S = 2.5\text{ A}, V_{GS} = 0\text{ V}^b$		-	-	1.6	V
Body Diode Reverse Recovery Time	$t_{rr}$	$T_J = 25\text{ }^\circ\text{C}, I_F = 3.6\text{ A}, di/dt = 100\text{ A}/\mu\text{s}^b$		-	400	810	ns
Body Diode Reverse Recovery Charge	$Q_{rr}$			-	2.1	4.2	$\mu\text{C}$
Forward Turn-On Time	$t_{on}$	Intrinsic turn-on time is negligible (turn-on is dominated by $L_S$ and $L_D$ )					

**Notes**

- a. Repetitive rating; pulse width limited by maximum junction temperature (see fig. 11).
- b. Pulse width  $\leq 300\text{ }\mu\text{s}$ ; duty cycle  $\leq 2\%$ .

**TYPICAL CHARACTERISTICS** 25 °C, unless otherwise noted

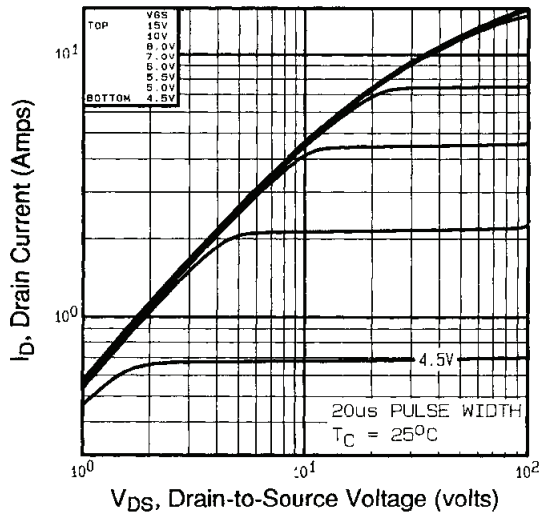

Fig. 1 - Typical Output Characteristics,  $T_C = 25\text{ }^\circ\text{C}$

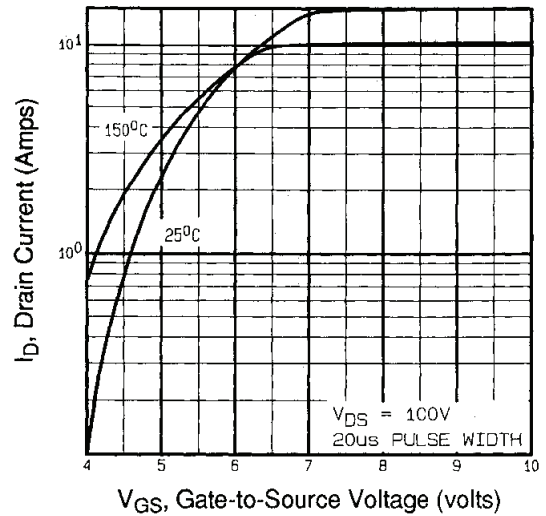

Fig. 3 - Typical Transfer Characteristics

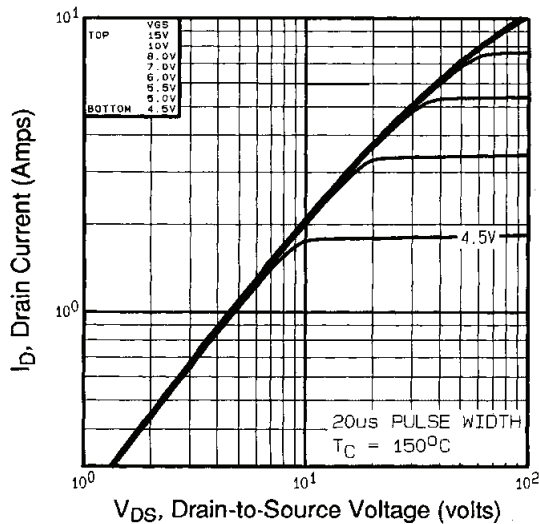

Fig. 2 - Typical Output Characteristics,  $T_C = 150\text{ }^\circ\text{C}$

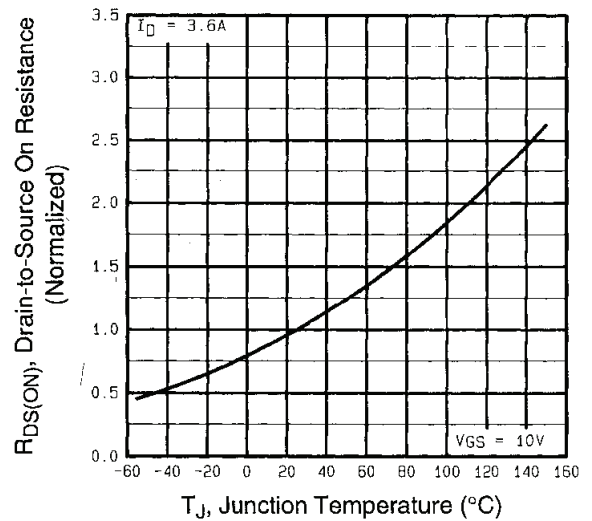

Fig. 4 - Normalized On-Resistance vs. Temperature

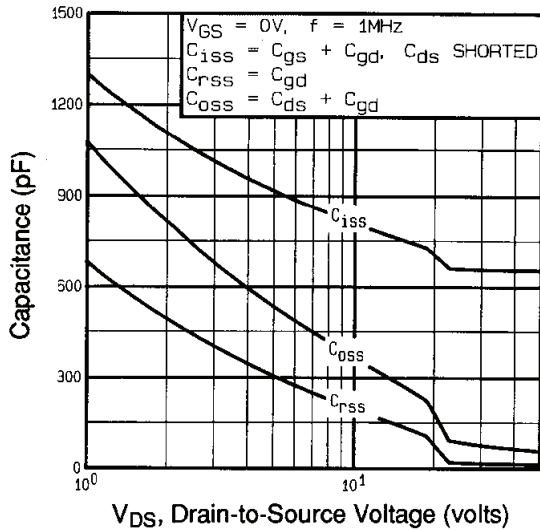

Fig. 5 - Typical Capacitance vs. Drain-to-Source Voltage

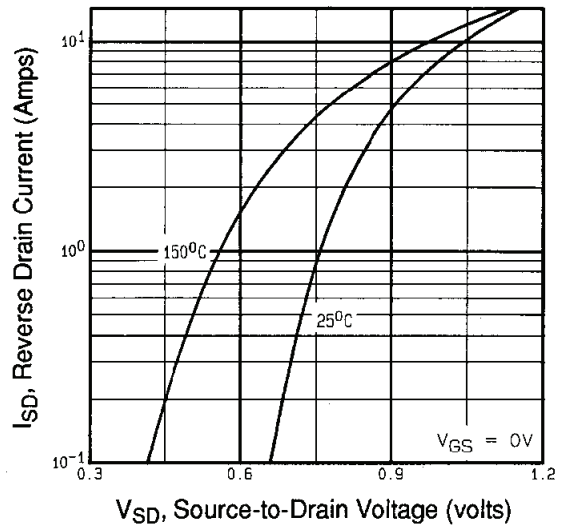

Fig. 7 - Typical Source-Drain Diode Forward Voltage

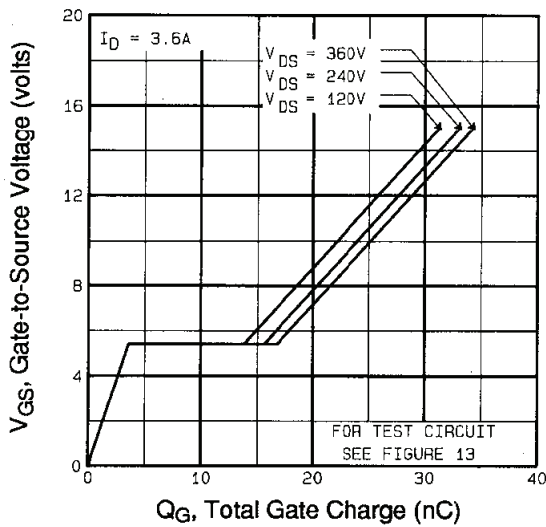

Fig. 6 - Typical Gate Charge vs. Gate-to-Source Voltage

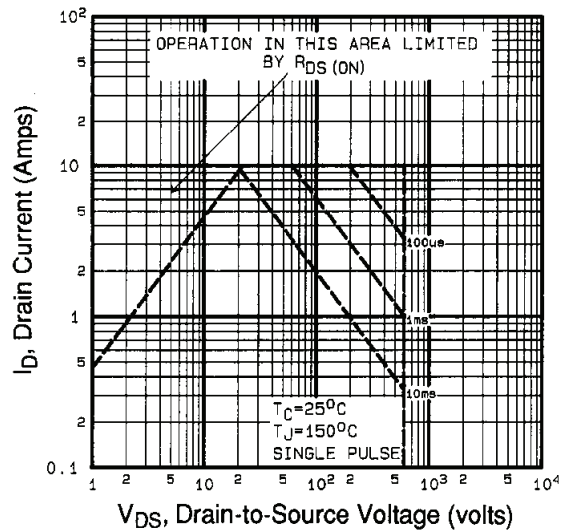

Fig. 8 - Maximum Safe Operating Area

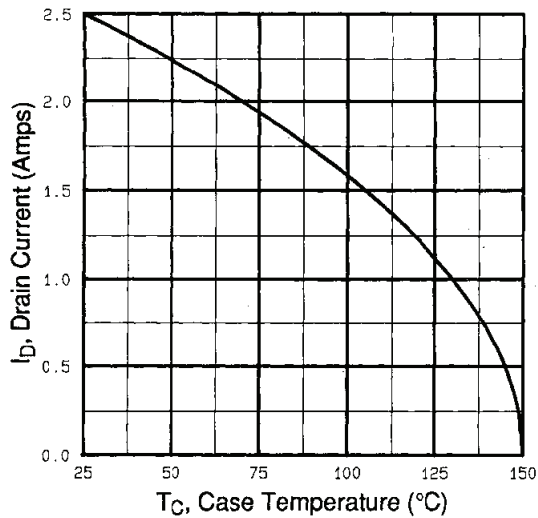

Fig. 9 - Maximum Drain Current vs. Case Temperature

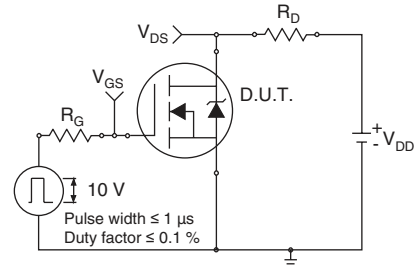

Fig. 10a - Switching Time Test Circuit



Fig. 10b - Switching Time Waveforms

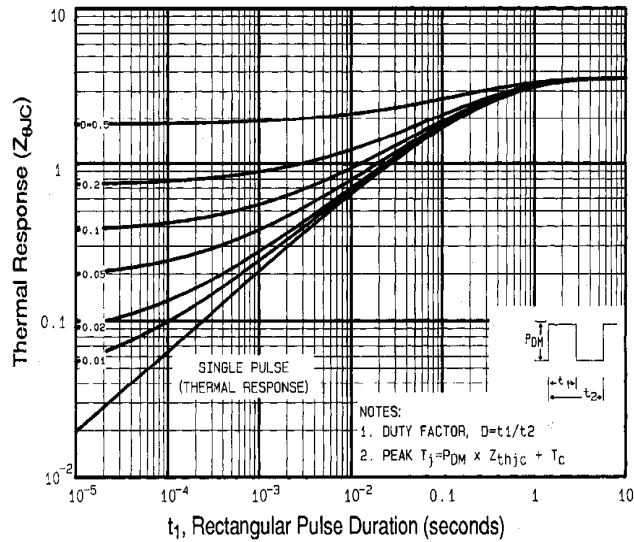

Fig. 11 - Maximum Effective Transient Thermal Impedance, Junction-to-Case

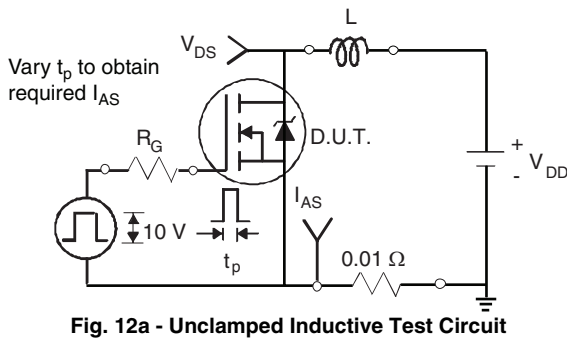

Fig. 12a - Unclamped Inductive Test Circuit

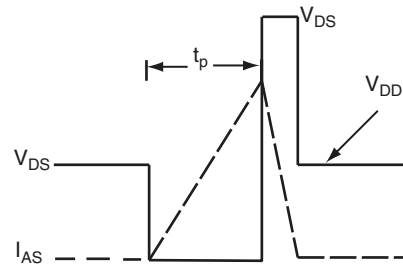

Fig. 12b - Unclamped Inductive Waveforms

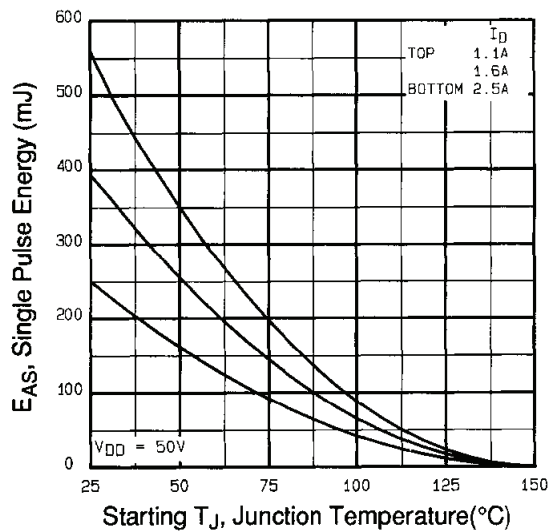

Fig. 12c - Maximum Avalanche Energy vs. Drain Current

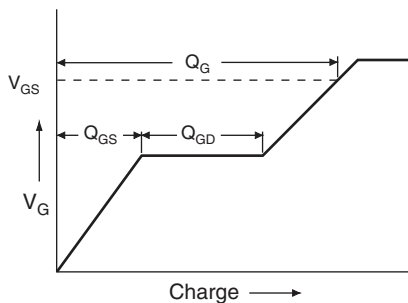

Fig. 13a - Basic Gate Charge Waveform

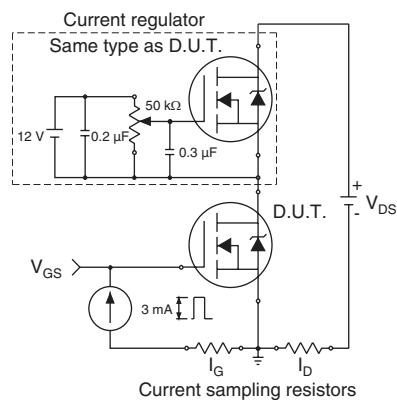
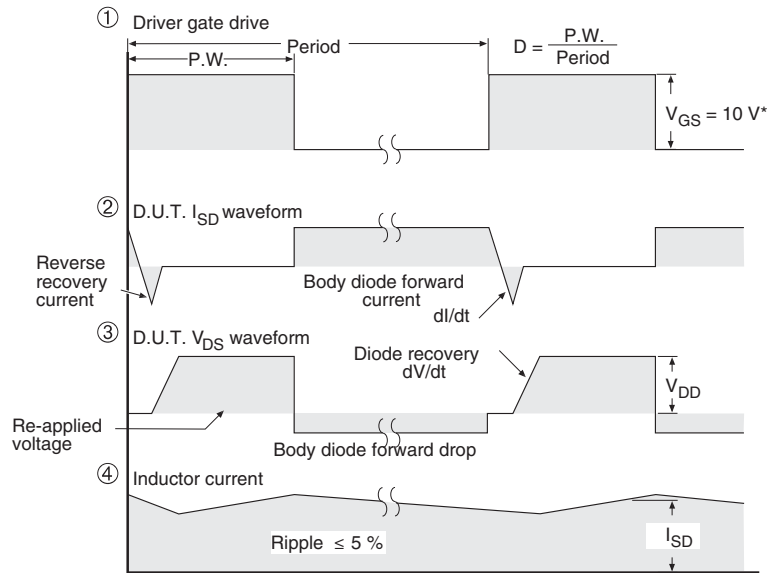
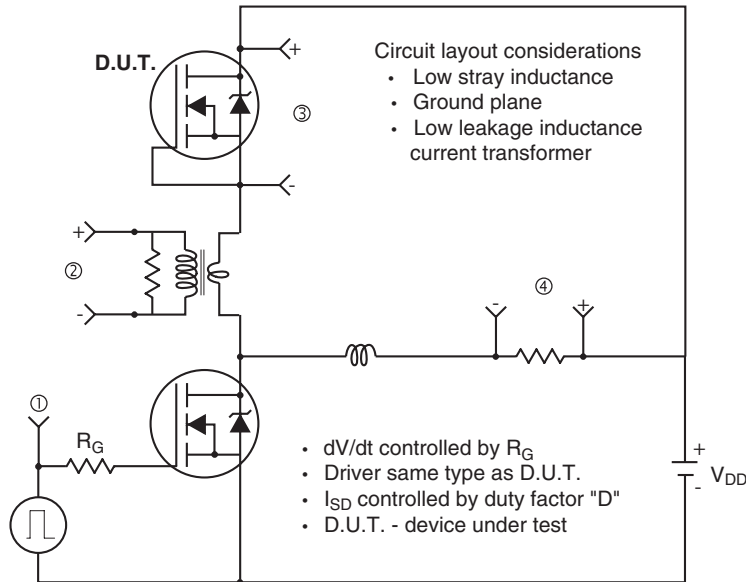

Fig. 13b - Gate Charge Test Circuit

## Peak Diode Recovery dV/dt Test Circuit



\*  $V_{GS} = 5 V$  for logic level devices and  $3 V$  drive devices

**Fig. 14 - For N-Channel**

Vishay Siliconix maintains worldwide manufacturing capability. Products may be manufactured at one of several qualified locations. Reliability data for Silicon Technology and Package Reliability represent a composite of all qualified locations. For related documents such as package/tape drawings, part marking, and reliability data, see [www.vishay.com/ppg291180](http://www.vishay.com/ppg291180).



## Disclaimer

ALL PRODUCT, PRODUCT SPECIFICATIONS AND DATA ARE SUBJECT TO CHANGE WITHOUT NOTICE TO IMPROVE RELIABILITY, FUNCTION OR DESIGN OR OTHERWISE.

Vishay Intertechnology, Inc., its affiliates, agents, and employees, and all persons acting on its or their behalf (collectively, "Vishay"), disclaim any and all liability for any errors, inaccuracies or incompleteness contained in any datasheet or in any other disclosure relating to any product.

Vishay makes no warranty, representation or guarantee regarding the suitability of the products for any particular purpose or the continuing production of any product. To the maximum extent permitted by applicable law, Vishay disclaims (i) any and all liability arising out of the application or use of any product, (ii) any and all liability, including without limitation special, consequential or incidental damages, and (iii) any and all implied warranties, including warranties of fitness for particular purpose, non-infringement and merchantability.

Statements regarding the suitability of products for certain types of applications are based on Vishay's knowledge of typical requirements that are often placed on Vishay products in generic applications. Such statements are not binding statements about the suitability of products for a particular application. It is the customer's responsibility to validate that a particular product with the properties described in the product specification is suitable for use in a particular application. Parameters provided in datasheets and/or specifications may vary in different applications and performance may vary over time. All operating parameters, including typical parameters, must be validated for each customer application by the customer's technical experts. Product specifications do not expand or otherwise modify Vishay's terms and conditions of purchase, including but not limited to the warranty expressed therein.

Except as expressly indicated in writing, Vishay products are not designed for use in medical, life-saving, or life-sustaining applications or for any other application in which the failure of the Vishay product could result in personal injury or death. Customers using or selling Vishay products not expressly indicated for use in such applications do so at their own risk. Please contact authorized Vishay personnel to obtain written terms and conditions regarding products designed for such applications.

No license, express or implied, by estoppel or otherwise, to any intellectual property rights is granted by this document or by any conduct of Vishay. Product names and markings noted herein may be trademarks of their respective owners.

## Material Category Policy

**Vishay Intertechnology, Inc. hereby certifies that all its products that are identified as RoHS-Compliant fulfill the definitions and restrictions defined under Directive 2011/65/EU of The European Parliament and of the Council of June 8, 2011 on the restriction of the use of certain hazardous substances in electrical and electronic equipment (EEE) - recast, unless otherwise specified as non-compliant.**

**Please note that some Vishay documentation may still make reference to RoHS Directive 2002/95/EC. We confirm that all the products identified as being compliant to Directive 2002/95/EC conform to Directive 2011/65/EU.**

**Vishay Intertechnology, Inc. hereby certifies that all its products that are identified as Halogen-Free follow Halogen-Free requirements as per JEDEC JS709A standards. Please note that some Vishay documentation may still make reference to the IEC 61249-2-21 definition. We confirm that all the products identified as being compliant to IEC 61249-2-21 conform to JEDEC JS709A standards.**