

To our customers,

Old Company Name in Catalogs and Other Documents

On April 1st, 2010, NEC Electronics Corporation merged with Renesas Technology Corporation, and Renesas Electronics Corporation took over all the business of both companies. Therefore, although the old company name remains in this document, it is a valid Renesas Electronics document. We appreciate your understanding.

Renesas Electronics website: <http://www.renesas.com>

April 1st, 2010
Renesas Electronics Corporation

Issued by: Renesas Electronics Corporation (<http://www.renesas.com>)

Send any inquiries to <http://www.renesas.com/inquiry>.

Notice

1. All information included in this document is current as of the date this document is issued. Such information, however, is subject to change without any prior notice. Before purchasing or using any Renesas Electronics products listed herein, please confirm the latest product information with a Renesas Electronics sales office. Also, please pay regular and careful attention to additional and different information to be disclosed by Renesas Electronics such as that disclosed through our website.
2. Renesas Electronics does not assume any liability for infringement of patents, copyrights, or other intellectual property rights of third parties by or arising from the use of Renesas Electronics products or technical information described in this document. No license, express, implied or otherwise, is granted hereby under any patents, copyrights or other intellectual property rights of Renesas Electronics or others.
3. You should not alter, modify, copy, or otherwise misappropriate any Renesas Electronics product, whether in whole or in part.
4. Descriptions of circuits, software and other related information in this document are provided only to illustrate the operation of semiconductor products and application examples. You are fully responsible for the incorporation of these circuits, software, and information in the design of your equipment. Renesas Electronics assumes no responsibility for any losses incurred by you or third parties arising from the use of these circuits, software, or information.
5. When exporting the products or technology described in this document, you should comply with the applicable export control laws and regulations and follow the procedures required by such laws and regulations. You should not use Renesas Electronics products or the technology described in this document for any purpose relating to military applications or use by the military, including but not limited to the development of weapons of mass destruction. Renesas Electronics products and technology may not be used for or incorporated into any products or systems whose manufacture, use, or sale is prohibited under any applicable domestic or foreign laws or regulations.
6. Renesas Electronics has used reasonable care in preparing the information included in this document, but Renesas Electronics does not warrant that such information is error free. Renesas Electronics assumes no liability whatsoever for any damages incurred by you resulting from errors in or omissions from the information included herein.
7. Renesas Electronics products are classified according to the following three quality grades: “Standard”, “High Quality”, and “Specific”. The recommended applications for each Renesas Electronics product depends on the product’s quality grade, as indicated below. You must check the quality grade of each Renesas Electronics product before using it in a particular application. You may not use any Renesas Electronics product for any application categorized as “Specific” without the prior written consent of Renesas Electronics. Further, you may not use any Renesas Electronics product for any application for which it is not intended without the prior written consent of Renesas Electronics. Renesas Electronics shall not be in any way liable for any damages or losses incurred by you or third parties arising from the use of any Renesas Electronics product for an application categorized as “Specific” or for which the product is not intended where you have failed to obtain the prior written consent of Renesas Electronics. The quality grade of each Renesas Electronics product is “Standard” unless otherwise expressly specified in a Renesas Electronics data sheets or data books, etc.
 - “Standard”: Computers; office equipment; communications equipment; test and measurement equipment; audio and visual equipment; home electronic appliances; machine tools; personal electronic equipment; and industrial robots.
 - “High Quality”: Transportation equipment (automobiles, trains, ships, etc.); traffic control systems; anti-disaster systems; anti-crime systems; safety equipment; and medical equipment not specifically designed for life support.
 - “Specific”: Aircraft; aerospace equipment; submersible repeaters; nuclear reactor control systems; medical equipment or systems for life support (e.g. artificial life support devices or systems), surgical implantations, or healthcare intervention (e.g. excision, etc.), and any other applications or purposes that pose a direct threat to human life.
8. You should use the Renesas Electronics products described in this document within the range specified by Renesas Electronics, especially with respect to the maximum rating, operating supply voltage range, movement power voltage range, heat radiation characteristics, installation and other product characteristics. Renesas Electronics shall have no liability for malfunctions or damages arising out of the use of Renesas Electronics products beyond such specified ranges.
9. Although Renesas Electronics endeavors to improve the quality and reliability of its products, semiconductor products have specific characteristics such as the occurrence of failure at a certain rate and malfunctions under certain use conditions. Further, Renesas Electronics products are not subject to radiation resistance design. Please be sure to implement safety measures to guard them against the possibility of physical injury, and injury or damage caused by fire in the event of the failure of a Renesas Electronics product, such as safety design for hardware and software including but not limited to redundancy, fire control and malfunction prevention, appropriate treatment for aging degradation or any other appropriate measures. Because the evaluation of microcomputer software alone is very difficult, please evaluate the safety of the final products or system manufactured by you.
10. Please contact a Renesas Electronics sales office for details as to environmental matters such as the environmental compatibility of each Renesas Electronics product. Please use Renesas Electronics products in compliance with all applicable laws and regulations that regulate the inclusion or use of controlled substances, including without limitation, the EU RoHS Directive. Renesas Electronics assumes no liability for damages or losses occurring as a result of your noncompliance with applicable laws and regulations.
11. This document may not be reproduced or duplicated, in any form, in whole or in part, without prior written consent of Renesas Electronics.
12. Please contact a Renesas Electronics sales office if you have any questions regarding the information contained in this document or Renesas Electronics products, or if you have any other inquiries.

(Note 1) “Renesas Electronics” as used in this document means Renesas Electronics Corporation and also includes its majority-owned subsidiaries.

(Note 2) “Renesas Electronics product(s)” means any product developed or manufactured by or for Renesas Electronics.

RQA0010VXDQS

Silicon N-Channel MOS FET

REJ03G1692-0200
Rev.2.00
Oct 29, 2008

Features

- High output power, High gain, High efficiency
Pout = +31.8 dBm, Linear Gain = 20 dB, PAE = 60%
(f = 450 MHz)
- Compact package capable of surface mounting
- Electrostatic Discharge Immunity Test
(IEC Standard 61000-4-2, Level 4)

Outline

RENESAS package code: PLZZ0004CA-A
(Package name: UPAK®)

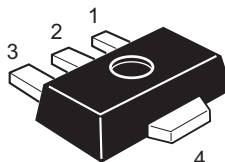

1. Gate
2. Source
3. Drain
4. Source

Note: Marking is "VX".

*UPAK is a trademark of Renesas Technology Corp.

Absolute Maximum Ratings

(Ta = 25°C)

Item	Symbol	Ratings	Unit
Drain to source voltage	V_{DSS}	16	V
Gate to source voltage	V_{GSS}	±5	V
Drain current	I_D	1.2	A
Channel dissipation	P_{ch}^{note}	9	W
Channel temperature	T_{ch}	150	°C
Storage temperature	T_{stg}	-55 to +150	°C

Note: Value at Tc = 25°C

Electrical Characteristics

(Ta = 25°C)

Item	Symbol	Min.	Typ	Max.	Unit	Test Conditions
Zero gate voltage drain current	I_{DSS}	—	—	10	μA	$V_{DS} = 16 V, V_{GS} = 0$
Gate to source leak current	I_{GSS}	—	—	± 2	μA	$V_{GS} = \pm 5 V, V_{DS} = 0$
Gate to source cutoff voltage	$V_{GS(off)}$	0.35	0.6	0.8	V	$V_{DS} = 4.5 V, I_D = 1 mA$
Forward Transfer Admittance	$ y_{fs} $	0.7	1.2	1.6	S	$V_{DS} = 4.5 V, I_D = 600 mA$
Input capacitance	C_{iss}	—	20	—	pF	$V_{GS} = 5 V, V_{DS} = 0, f = 1 MHz$
Output capacitance	C_{oss}	—	12	—	pF	$V_{DS} = 4.5 V, V_{GS} = 0, f = 1 MHz$
Reverse transfer capacitance	C_{rss}	—	1.5	—	pF	$V_{DG} = 4.5 V, V_{GS} = 0, f = 1 MHz$
Output Power	Pout	30.5	31.8	—	dBm	$V_{DS} = 4.5 V, I_D = 150 mA$
		1.12	1.5	—	W	$f = 450 MHz,$
Power Added Efficiency	PAE	55	60	—	%	Pin = +17 dBm (50 mW)

Main Characteristics

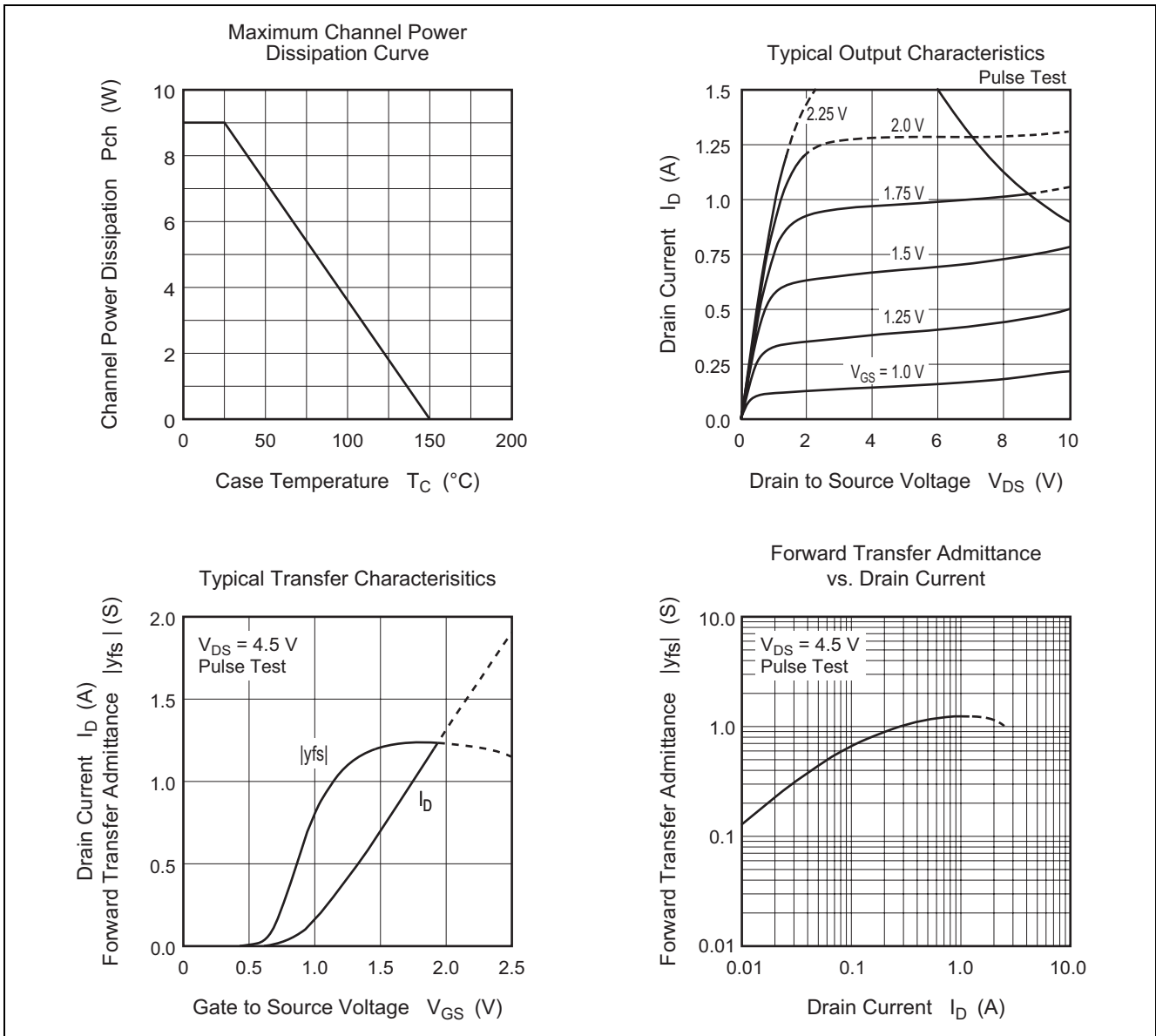

Input Capacitance vs. Gate to Source Voltage

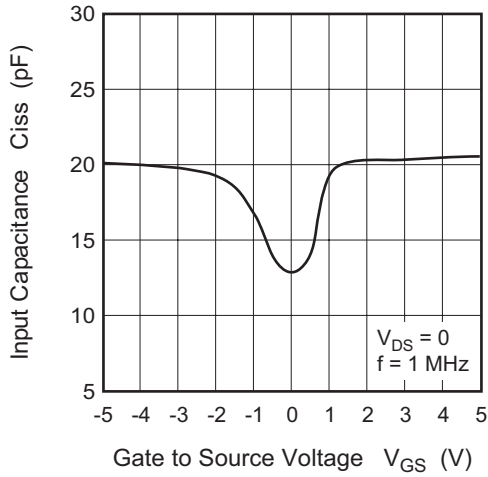

Output Capacitance vs. Drain to Source Voltage

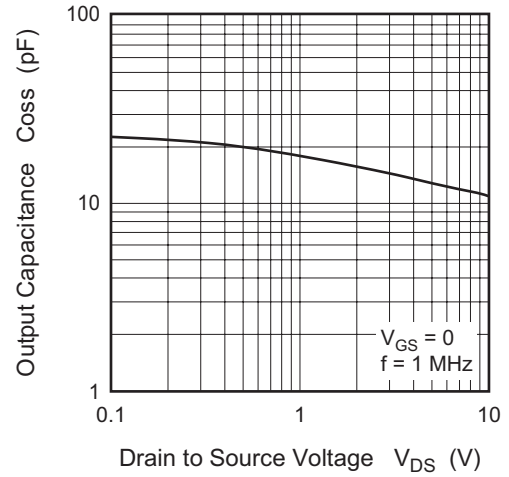

Reverse Transfer Capacitance vs. Drain to Gate Voltage

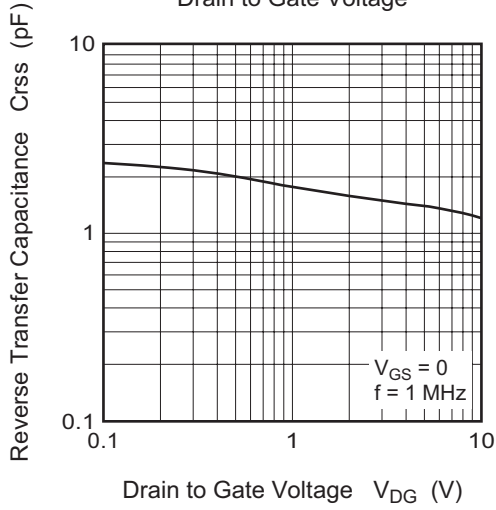

MSG, MAG, $|S_{21}|^2$ vs. Frequency

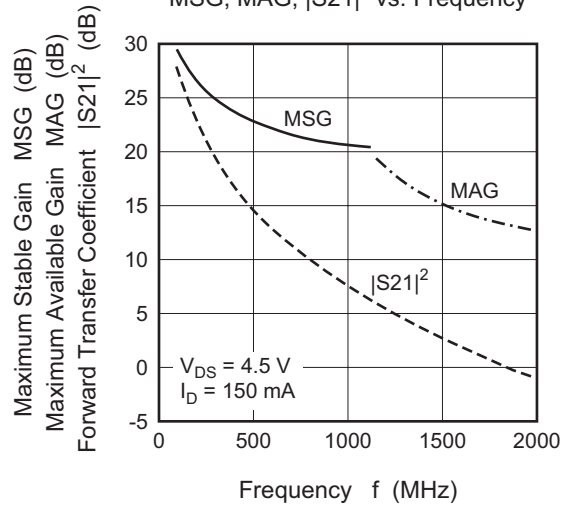

Maximum Stable Gain, $|S_{21}|^2$ vs. Drain Current

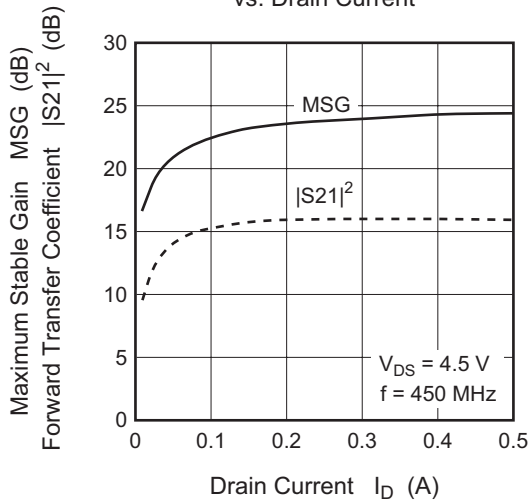

Output Power, Drain Current vs. Input Power

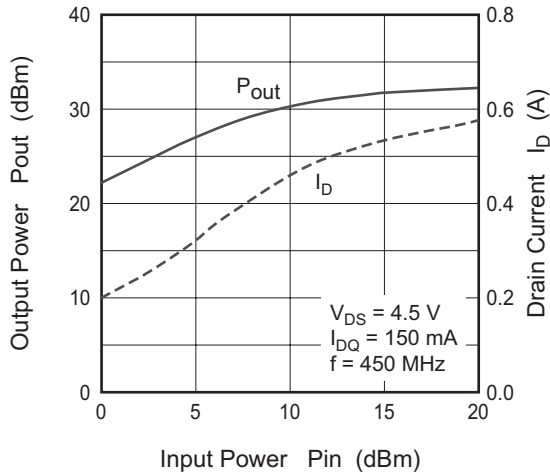

Power Gain, Power Added Efficiency, vs. Input Power

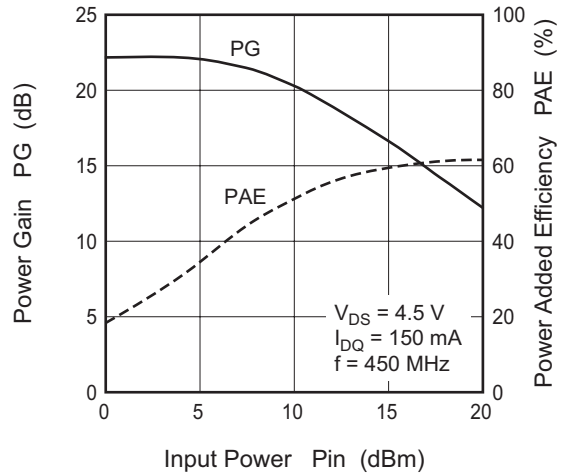

Output Power vs. Input Power

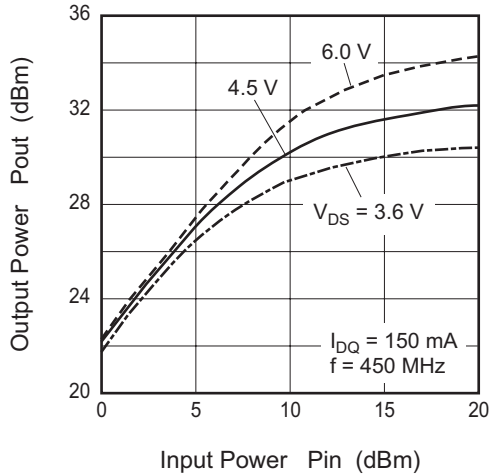

Drain Current vs. Input Power

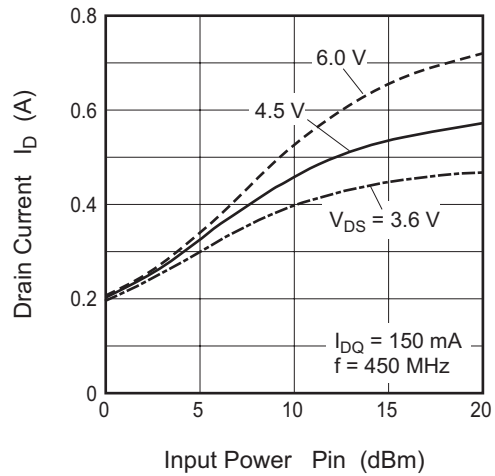

Output Power vs. Input Power

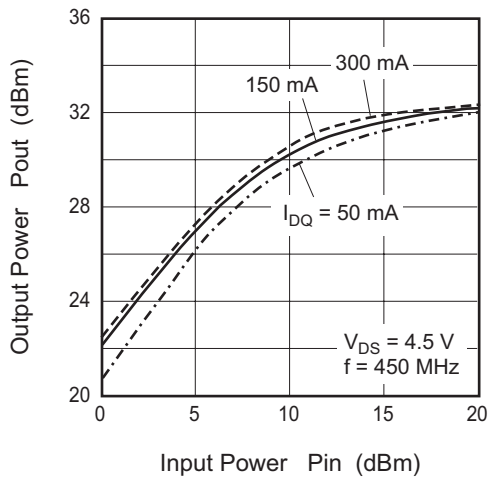

Drain Current vs. Input Power

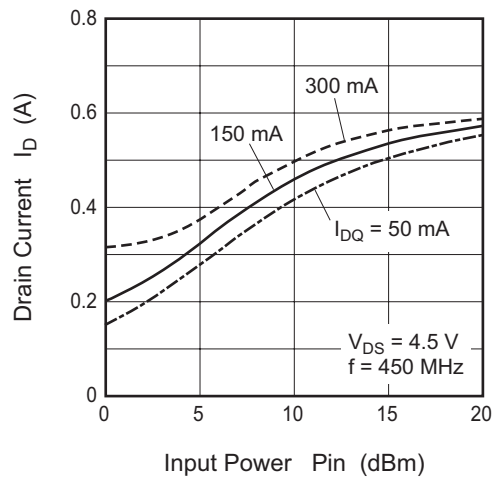

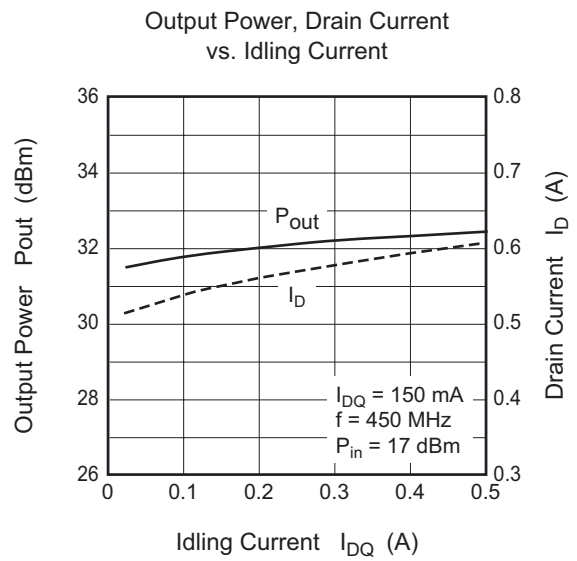
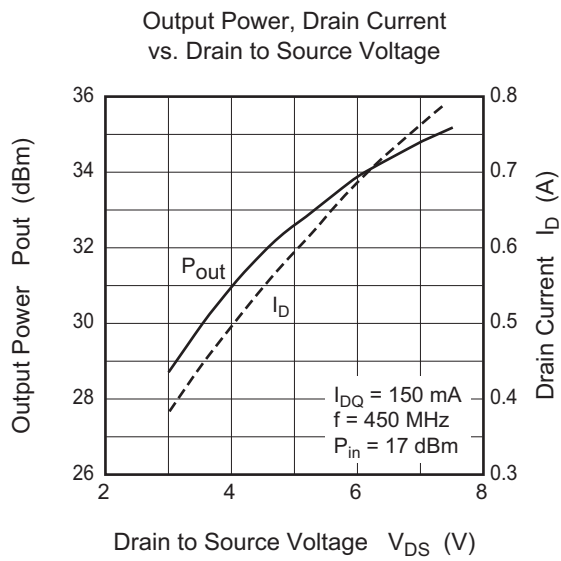
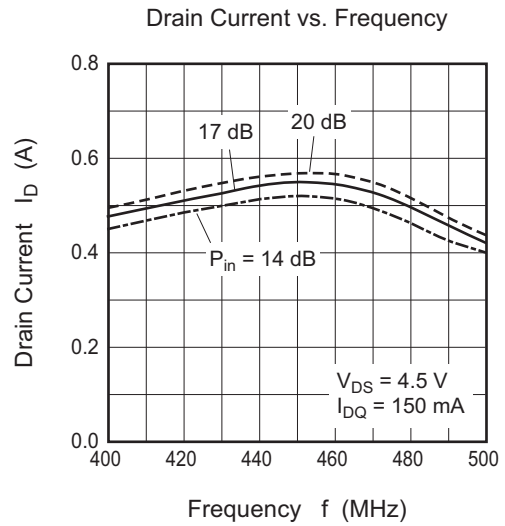
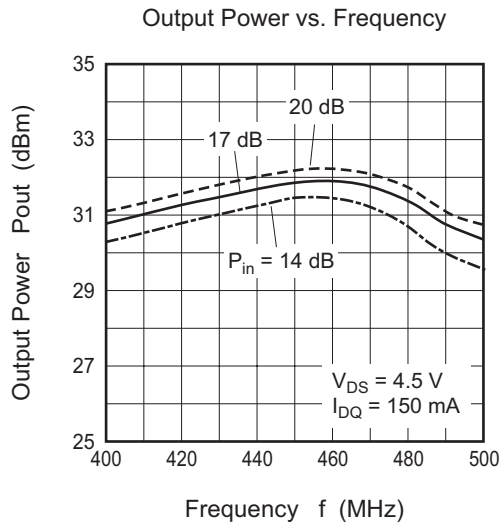

Evaluation Circuit (f = 450 MHz)

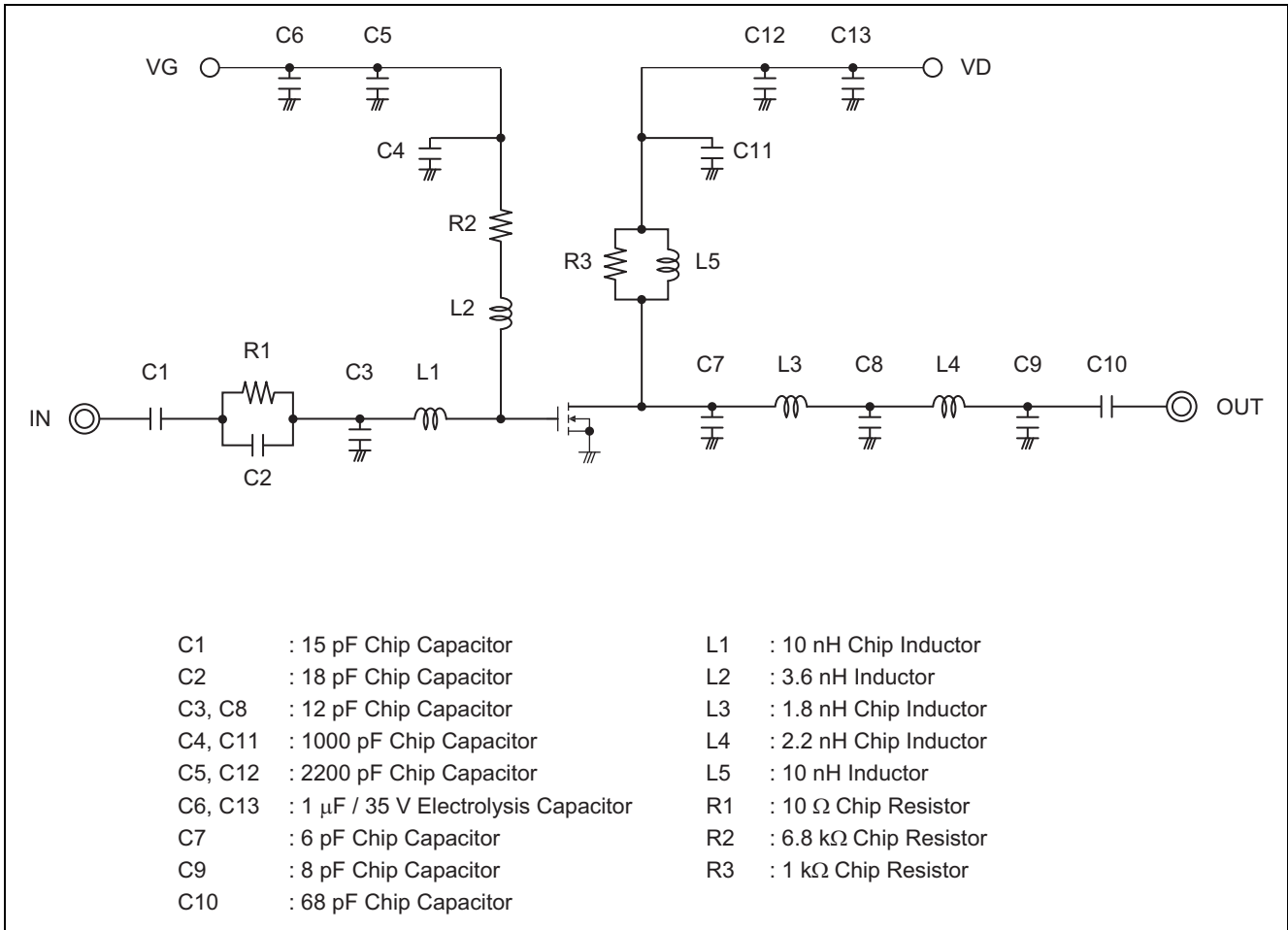

Large Signal Impedance

Item	Symbol	Result	Unit	Test Conditions
Frequency	f	450	MHz	V _{DS} = 4.5 V, I _{DQ} = 150 mA, Pin = 17 dBm, Pout = 31.8 dBm, PAE = 60%
Source Impedance	Z _S	0.15 + j0.2	Ω	
Load Impedance	Z _L ^{note}	0.13 - j0.01	Ω	

Note: Z_L was selected to get the best balance of Pout and PAE.

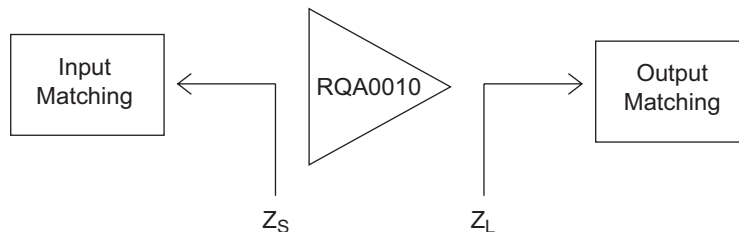

S₁₁ Parameter vs. Frequency

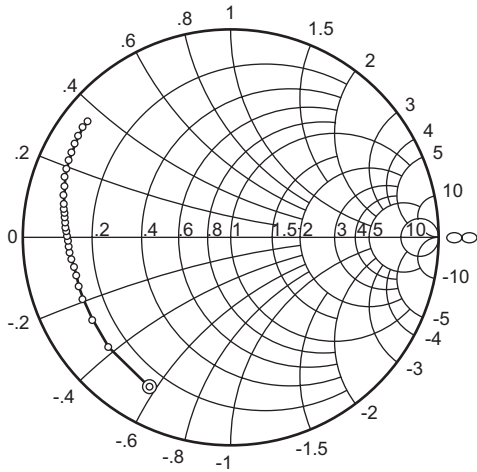

Condition: V_{DS} = 4.5 V, I_{DQ} = 150 mA, Z₀ = 50 Ω
 100 to 1000 MHz (50 MHz Step)
 1000 to 2000 MHz (100 MHz Step)

S₂₁ Parameter vs. Frequency

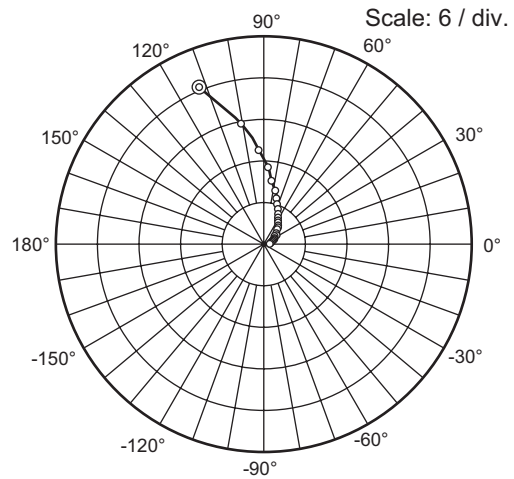

Condition: V_{DS} = 4.5 V, I_{DQ} = 150 mA, Z₀ = 50 Ω
 100 to 1000 MHz (50 MHz Step)
 1000 to 2000 MHz (100 MHz Step)

S₁₂ Parameter vs. Frequency

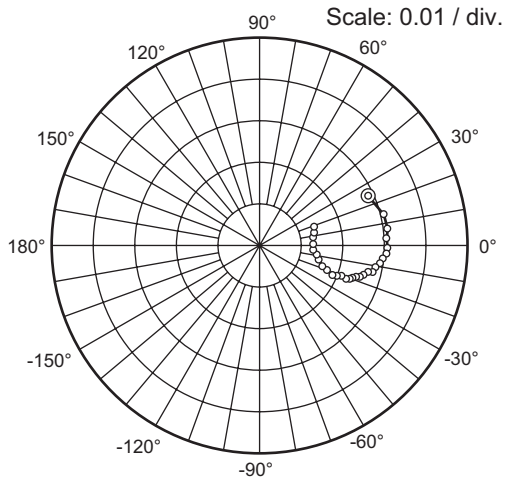

Condition: V_{DS} = 4.5 V, I_{DQ} = 150 mA, Z₀ = 50 Ω
 100 to 1000 MHz (50 MHz Step)
 1000 to 2000 MHz (100 MHz Step)

S₂₂ Parameter vs. Frequency

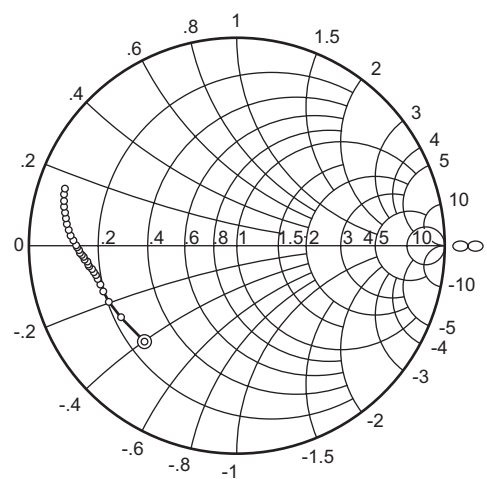

Condition: V_{DS} = 4.5 V, I_{DQ} = 150 mA, Z₀ = 50 Ω
 100 to 1000 MHz (50 MHz Step)
 1000 to 2000 MHz (100 MHz Step)

S Parameter

(V_{DS} = 3.0 V, I_D = 150 mA, Z_o = 50 Ω)

f (MHz)	S11		S21		S12		S22	
	MAG	ANG (deg.)	MAG	ANG (deg.)	MAG	ANG (deg.)	MAG	ANG (deg.)
100	0.816	-119.8	21.59	111.2	0.030	22.5	0.653	-136.4
150	0.782	-138.3	16.09	99.7	0.031	12.5	0.672	-150.3
200	0.766	-149.4	12.54	91.8	0.031	6.6	0.688	-157.6
250	0.761	-156.8	10.19	85.9	0.031	1.0	0.693	-162.0
300	0.760	-161.6	8.55	81.4	0.031	-1.7	0.700	-165.2
350	0.758	-165.7	7.29	76.8	0.031	-5.2	0.706	-167.3
400	0.763	-168.9	6.35	73.1	0.030	-7.6	0.709	-168.7
450	0.765	-171.4	5.60	69.4	0.030	-9.7	0.716	-170.3
500	0.770	-173.7	5.00	65.8	0.029	-11.9	0.722	-171.6
550	0.774	-176.0	4.50	62.4	0.028	-14.2	0.731	-172.8
600	0.777	-177.9	4.09	59.2	0.027	-15.4	0.736	-173.5
650	0.782	-179.4	3.73	56.2	0.027	-17.5	0.740	-174.5
700	0.787	178.8	3.42	53.2	0.026	-18.2	0.751	-175.6
750	0.790	177.3	3.15	50.3	0.024	-20.3	0.756	-176.6
800	0.795	175.6	2.92	47.5	0.024	-21.4	0.762	-177.2
850	0.802	174.2	2.69	44.6	0.023	-22.3	0.769	-178.3
900	0.803	172.7	2.51	41.9	0.022	-22.2	0.777	-179.2
950	0.809	171.1	2.34	39.3	0.021	-23.5	0.786	179.9
1000	0.814	169.4	2.20	36.9	0.020	-23.8	0.790	179.3
1050	0.818	168.0	2.06	34.5	0.020	-23.0	0.796	178.3
1100	0.822	166.6	1.93	31.9	0.018	-22.7	0.804	177.4
1150	0.827	165.2	1.82	29.5	0.018	-21.5	0.809	176.4
1200	0.835	163.8	1.72	27.2	0.017	-20.8	0.815	175.7
1250	0.838	162.3	1.63	25.1	0.016	-20.9	0.819	174.9
1300	0.844	160.9	1.54	22.7	0.016	-19.3	0.826	173.9
1350	0.847	159.3	1.45	20.4	0.015	-17.5	0.832	172.9
1400	0.851	158.1	1.38	18.3	0.014	-15.6	0.837	172.0
1450	0.854	156.8	1.32	16.2	0.014	-13.3	0.840	171.0
1500	0.858	155.4	1.25	14.4	0.013	-11.2	0.846	170.2
1550	0.861	154.0	1.18	12.1	0.014	-8.0	0.847	169.1
1600	0.862	152.6	1.13	10.1	0.013	-4.8	0.854	168.4
1650	0.862	151.1	1.08	8.1	0.012	-1.2	0.858	167.4
1700	0.869	149.5	1.03	6.4	0.012	1.8	0.862	166.6
1750	0.874	148.3	0.98	4.5	0.012	4.6	0.864	165.6
1800	0.874	147.0	0.94	2.5	0.013	8.8	0.869	164.7
1850	0.874	145.4	0.90	0.7	0.013	10.9	0.873	163.6
1900	0.881	143.7	0.87	-0.8	0.013	13.8	0.874	162.7
1950	0.888	143.0	0.83	-2.5	0.013	16.5	0.879	161.8
2000	0.879	141.6	0.80	-4.3	0.014	17.7	0.880	161.0

S Parameter

(V_{DS} = 3.3 V, I_D = 150 mA, Z_o = 50 Ω)

f (MHz)	S11		S21		S12		S22	
	MAG	ANG (deg.)	MAG	ANG (deg.)	MAG	ANG (deg.)	MAG	ANG (deg.)
100	0.814	-119.6	22.46	111.2	0.030	23.3	0.651	-136.0
150	0.779	-138.3	16.58	99.8	0.031	12.7	0.669	-149.8
200	0.767	-149.4	12.82	92.0	0.031	6.5	0.685	-157.2
250	0.762	-156.8	10.39	86.1	0.031	1.9	0.691	-161.7
300	0.764	-161.7	8.72	81.5	0.031	-1.7	0.697	-164.8
350	0.759	-165.7	7.42	76.9	0.030	-5.0	0.701	-167.0
400	0.761	-168.8	6.46	73.3	0.030	-7.1	0.706	-168.6
450	0.767	-171.5	5.71	69.6	0.029	-9.9	0.711	-170.1
500	0.770	-173.8	5.09	66.0	0.029	-12.3	0.720	-171.3
550	0.775	-176.0	4.58	62.6	0.028	-13.7	0.727	-172.6
600	0.776	-177.8	4.16	59.4	0.027	-15.3	0.732	-173.3
650	0.782	-179.6	3.81	56.5	0.026	-17.5	0.737	-174.3
700	0.787	178.7	3.48	53.4	0.026	-18.9	0.745	-175.3
750	0.792	177.2	3.20	50.5	0.025	-19.9	0.751	-176.4
800	0.795	175.6	2.97	47.7	0.024	-21.1	0.758	-176.9
850	0.802	174.1	2.75	45.0	0.023	-21.7	0.766	-178.0
900	0.802	172.6	2.56	42.1	0.022	-22.4	0.773	-179.0
950	0.809	171.1	2.39	39.5	0.021	-23.1	0.781	-179.8
1000	0.812	169.4	2.24	37.1	0.020	-22.5	0.786	179.4
1050	0.818	167.9	2.10	34.7	0.020	-23.0	0.794	178.5
1100	0.822	166.6	1.97	32.1	0.019	-22.6	0.801	177.6
1150	0.829	165.1	1.86	29.7	0.018	-21.3	0.805	176.6
1200	0.834	163.7	1.75	27.5	0.017	-21.3	0.812	176.0
1250	0.838	162.3	1.66	25.3	0.016	-20.3	0.818	175.1
1300	0.843	160.8	1.57	23.1	0.015	-19.5	0.821	174.1
1350	0.847	159.3	1.48	20.7	0.015	-16.4	0.828	173.2
1400	0.851	158.2	1.41	18.6	0.014	-15.1	0.832	172.3
1450	0.854	156.8	1.34	16.5	0.014	-12.7	0.836	171.3
1500	0.858	155.3	1.28	14.6	0.013	-11.3	0.843	170.4
1550	0.861	154.0	1.21	12.5	0.013	-8.7	0.846	169.5
1600	0.863	152.6	1.15	10.3	0.013	-6.2	0.851	168.6
1650	0.863	151.1	1.10	8.4	0.013	-1.5	0.856	167.7
1700	0.867	149.5	1.06	6.7	0.013	0.4	0.861	166.8
1750	0.874	148.2	1.01	4.9	0.013	3.7	0.861	165.9
1800	0.874	147.0	0.96	2.8	0.012	8.5	0.867	165.0
1850	0.872	145.3	0.92	0.9	0.013	10.5	0.870	163.8
1900	0.881	143.7	0.89	-0.6	0.013	13.9	0.873	162.9
1950	0.887	143.0	0.85	-2.3	0.014	15.6	0.877	162.1
2000	0.876	141.7	0.82	-4.0	0.013	18.0	0.878	161.2

S Parameter

(V_{DS} = 3.6 V, I_D = 150 mA, Z_o = 50 Ω)

f (MHz)	S11		S21		S12		S22	
	MAG	ANG (deg.)	MAG	ANG (deg.)	MAG	ANG (deg.)	MAG	ANG (deg.)
100	0.814	-119.4	23.16	111.3	0.030	23.2	0.647	-135.0
150	0.781	-138.0	16.92	100.0	0.031	12.8	0.668	-149.4
200	0.768	-149.4	13.07	92.1	0.031	6.4	0.682	-156.7
250	0.763	-156.9	10.58	86.2	0.031	1.8	0.687	-161.3
300	0.762	-161.6	8.86	81.7	0.031	-1.9	0.694	-164.6
350	0.760	-165.9	7.55	77.2	0.030	-5.0	0.697	-166.8
400	0.765	-168.9	6.57	73.5	0.030	-6.5	0.702	-168.3
450	0.766	-171.5	5.79	69.7	0.029	-9.8	0.709	-169.9
500	0.772	-173.9	5.18	66.3	0.029	-12.1	0.716	-171.2
550	0.776	-176.0	4.67	62.9	0.028	-14.3	0.724	-172.3
600	0.778	-177.8	4.23	59.6	0.027	-15.7	0.728	-173.1
650	0.783	-179.5	3.86	56.6	0.026	-16.7	0.735	-174.3
700	0.787	178.6	3.54	53.7	0.025	-18.3	0.744	-175.2
750	0.791	177.1	3.27	50.9	0.025	-19.4	0.748	-176.1
800	0.797	175.6	3.02	47.9	0.024	-20.2	0.756	-176.8
850	0.801	174.1	2.80	45.2	0.023	-21.1	0.763	-177.9
900	0.803	172.5	2.61	42.5	0.022	-21.4	0.770	-178.8
950	0.809	171.0	2.43	39.9	0.021	-22.3	0.779	-179.8
1000	0.813	169.4	2.29	37.5	0.020	-23.6	0.785	179.7
1050	0.818	167.9	2.14	34.9	0.020	-22.4	0.790	178.8
1100	0.821	166.5	2.01	32.5	0.019	-23.4	0.797	177.7
1150	0.827	165.1	1.90	30.1	0.018	-21.6	0.803	176.9
1200	0.833	163.7	1.79	27.9	0.017	-20.9	0.808	176.3
1250	0.839	162.3	1.69	25.5	0.017	-20.8	0.815	175.2
1300	0.842	160.7	1.60	23.3	0.016	-19.0	0.819	174.2
1350	0.846	159.3	1.52	21.1	0.015	-17.3	0.826	173.3
1400	0.850	158.0	1.44	19.0	0.015	-15.5	0.831	172.4
1450	0.854	156.7	1.37	16.9	0.014	-13.8	0.834	171.6
1500	0.858	155.3	1.30	14.9	0.014	-11.8	0.840	170.6
1550	0.860	154.0	1.23	12.7	0.013	-8.1	0.843	169.6
1600	0.861	152.5	1.18	10.7	0.013	-4.4	0.850	168.7
1650	0.862	151.1	1.13	8.7	0.013	-3.8	0.854	167.9
1700	0.867	149.5	1.08	7.0	0.013	0.5	0.859	167.0
1750	0.873	148.3	1.03	5.0	0.013	4.7	0.859	166.1
1800	0.872	147.0	0.98	3.1	0.013	8.5	0.864	165.1
1850	0.873	145.3	0.95	1.3	0.013	10.7	0.867	164.0
1900	0.881	143.6	0.91	-0.2	0.013	13.5	0.870	163.0
1950	0.888	143.1	0.87	-2.0	0.013	15.9	0.875	162.2
2000	0.875	141.8	0.83	-3.9	0.014	19.1	0.875	161.3

S Parameter

(V_{DS} = 3.9 V, I_D = 150 mA, Z_o = 50 Ω)

f (MHz)	S11		S21		S12		S22	
	MAG	ANG (deg.)	MAG	ANG (deg.)	MAG	ANG (deg.)	MAG	ANG (deg.)
100	0.814	-118.9	23.65	111.6	0.029	23.8	0.646	-134.5
150	0.784	-138.0	17.21	100.2	0.031	13.5	0.664	-149.0
200	0.770	-149.3	13.26	92.3	0.031	6.4	0.679	-156.2
250	0.764	-156.5	10.71	86.3	0.031	2.4	0.684	-161.0
300	0.763	-161.6	8.99	81.8	0.031	-1.4	0.691	-164.3
350	0.762	-165.8	7.66	77.3	0.030	-4.7	0.695	-166.4
400	0.764	-168.7	6.65	73.6	0.030	-7.7	0.699	-168.2
450	0.767	-171.6	5.88	69.9	0.029	-9.8	0.706	-169.7
500	0.773	-173.8	5.26	66.5	0.029	-11.1	0.713	-171.0
550	0.776	-176.1	4.73	63.0	0.028	-13.1	0.720	-172.0
600	0.777	-177.8	4.28	59.8	0.027	-15.0	0.726	-173.0
650	0.783	-179.7	3.92	56.9	0.027	-16.7	0.732	-174.0
700	0.789	178.6	3.60	53.9	0.026	-18.0	0.740	-174.9
750	0.792	177.1	3.32	51.1	0.025	-19.5	0.745	-175.8
800	0.795	175.6	3.06	48.1	0.024	-20.0	0.753	-176.5
850	0.803	174.1	2.84	45.5	0.023	-21.1	0.759	-177.7
900	0.803	172.5	2.65	42.8	0.022	-22.2	0.766	-178.5
950	0.808	170.9	2.47	40.2	0.021	-22.4	0.776	-179.4
1000	0.813	169.3	2.31	37.6	0.021	-22.1	0.781	179.8
1050	0.817	168.0	2.17	35.2	0.020	-21.5	0.787	178.8
1100	0.821	166.4	2.04	32.8	0.019	-22.3	0.793	178.0
1150	0.827	165.0	1.93	30.4	0.018	-21.7	0.800	177.1
1200	0.833	163.7	1.81	28.0	0.017	-22.1	0.806	176.5
1250	0.838	162.2	1.72	25.8	0.016	-20.0	0.813	175.4
1300	0.842	160.7	1.63	23.6	0.015	-19.6	0.817	174.5
1350	0.847	159.2	1.54	21.4	0.015	-17.9	0.823	173.5
1400	0.851	158.0	1.47	19.2	0.015	-15.5	0.829	172.7
1450	0.852	156.7	1.39	17.0	0.014	-15.1	0.831	171.7
1500	0.857	155.2	1.32	15.1	0.014	-10.6	0.837	170.8
1550	0.859	154.0	1.26	13.0	0.013	-8.1	0.840	169.8
1600	0.861	152.6	1.20	11.0	0.013	-5.6	0.848	169.1
1650	0.863	151.1	1.15	8.9	0.013	-1.1	0.850	168.0
1700	0.867	149.5	1.09	7.1	0.013	1.4	0.856	167.2
1750	0.873	148.2	1.05	5.3	0.013	4.5	0.857	166.2
1800	0.871	147.0	1.00	3.3	0.013	7.7	0.861	165.5
1850	0.872	145.3	0.97	1.5	0.013	9.8	0.866	164.3
1900	0.881	143.6	0.92	-0.1	0.013	12.4	0.868	163.4
1950	0.889	143.1	0.89	-1.9	0.013	15.1	0.873	162.5
2000	0.875	141.7	0.85	-3.6	0.014	17.1	0.874	161.5

S Parameter

(V_{DS} = 4.2 V, I_D = 150 mA, Z_o = 50 Ω)

f (MHz)	S11		S21		S12		S22	
	MAG	ANG (deg.)	MAG	ANG (deg.)	MAG	ANG (deg.)	MAG	ANG (deg.)
100	0.814	-118.7	24.09	111.8	0.029	24.6	0.643	-133.8
150	0.784	-137.5	17.42	100.4	0.031	13.5	0.661	-148.4
200	0.771	-149.1	13.42	92.4	0.031	7.1	0.676	-156.1
250	0.765	-156.5	10.86	86.5	0.031	2.4	0.679	-160.6
300	0.764	-161.4	9.09	82.0	0.031	-1.3	0.687	-164.0
350	0.763	-165.7	7.75	77.5	0.030	-4.5	0.693	-166.3
400	0.766	-168.7	6.74	73.8	0.030	-6.7	0.695	-167.8
450	0.767	-171.5	5.95	70.1	0.030	-9.4	0.703	-169.4
500	0.773	-173.8	5.32	66.6	0.029	-11.2	0.711	-170.8
550	0.777	-176.0	4.79	63.2	0.028	-13.4	0.717	-171.8
600	0.779	-178.0	4.35	60.0	0.027	-15.5	0.722	-172.7
650	0.784	-179.6	3.97	57.0	0.026	-16.8	0.728	-173.8
700	0.791	178.6	3.64	54.1	0.025	-17.5	0.738	-174.7
750	0.792	177.1	3.36	51.2	0.025	-18.7	0.742	-175.7
800	0.797	175.4	3.11	48.4	0.024	-20.1	0.749	-176.3
850	0.802	174.1	2.88	45.6	0.023	-21.0	0.755	-177.5
900	0.804	172.5	2.69	42.9	0.022	-22.7	0.763	-178.4
950	0.808	170.9	2.51	40.3	0.021	-21.9	0.772	-179.4
1000	0.814	169.4	2.35	37.9	0.021	-22.9	0.778	-179.8
1050	0.817	167.8	2.21	35.5	0.020	-22.7	0.784	179.1
1100	0.823	166.5	2.07	32.9	0.019	-22.2	0.791	178.2
1150	0.828	165.0	1.96	30.6	0.018	-21.4	0.796	177.2
1200	0.833	163.6	1.85	28.3	0.017	-21.2	0.804	176.6
1250	0.838	162.2	1.75	26.1	0.017	-20.4	0.810	175.7
1300	0.843	160.7	1.65	23.7	0.016	-19.1	0.814	174.6
1350	0.845	159.3	1.56	21.5	0.015	-17.4	0.819	173.8
1400	0.849	158.0	1.49	19.4	0.014	-15.3	0.825	172.8
1450	0.853	156.7	1.42	17.3	0.014	-13.2	0.829	171.9
1500	0.857	155.2	1.35	15.4	0.014	-11.9	0.835	171.1
1550	0.859	154.1	1.28	13.1	0.013	-9.2	0.837	170.0
1600	0.861	152.5	1.22	11.1	0.013	-5.3	0.845	169.2
1650	0.862	151.1	1.17	9.1	0.013	-3.7	0.847	168.3
1700	0.866	149.5	1.12	7.4	0.012	-0.7	0.854	167.6
1750	0.873	148.2	1.06	5.4	0.013	2.8	0.855	166.4
1800	0.871	147.1	1.02	3.4	0.013	5.9	0.861	165.5
1850	0.873	145.3	0.98	1.6	0.013	9.5	0.864	164.4
1900	0.880	143.6	0.94	0.1	0.013	11.4	0.867	163.6
1950	0.888	143.1	0.90	-1.6	0.014	13.8	0.870	162.6
2000	0.874	141.7	0.86	-3.5	0.014	17.6	0.873	161.7

S Parameter

(V_{DS} = 4.5 V, I_D = 150 mA, Z_o = 50 Ω)

f (MHz)	S11		S21		S12		S22	
	MAG	ANG (deg.)	MAG	ANG (deg.)	MAG	ANG (deg.)	MAG	ANG (deg.)
100	0.818	-118.3	24.40	111.9	0.029	24.2	0.642	-134.0
150	0.790	-137.6	17.67	100.5	0.031	13.9	0.659	-148.1
200	0.774	-148.8	13.58	92.6	0.031	7.1	0.674	-155.9
250	0.768	-156.6	10.99	86.7	0.031	2.8	0.680	-160.8
300	0.767	-161.5	9.23	82.2	0.031	-1.6	0.684	-163.8
350	0.764	-165.6	7.85	77.7	0.031	-4.2	0.689	-166.2
400	0.767	-168.7	6.83	74.1	0.030	-6.6	0.693	-167.9
450	0.771	-171.6	6.05	70.4	0.029	-8.7	0.699	-169.4
500	0.776	-174.0	5.41	66.9	0.028	-11.1	0.708	-170.7
550	0.778	-176.0	4.86	63.4	0.028	-13.5	0.715	-171.8
600	0.780	-178.0	4.41	60.3	0.027	-14.0	0.720	-172.7
650	0.785	-179.7	4.04	57.4	0.026	-16.4	0.724	-173.6
700	0.789	178.5	3.70	54.4	0.025	-17.9	0.734	-174.6
750	0.792	177.1	3.41	51.5	0.025	-18.6	0.740	-175.5
800	0.796	175.4	3.16	48.7	0.024	-19.4	0.747	-176.4
850	0.802	173.9	2.93	46.1	0.023	-20.9	0.754	-177.3
900	0.803	172.3	2.74	43.3	0.022	-21.5	0.760	-178.3
950	0.809	170.9	2.54	40.6	0.021	-21.2	0.769	-179.2
1000	0.813	169.3	2.39	38.2	0.020	-22.2	0.774	-180.0
1050	0.817	167.9	2.25	35.9	0.020	-21.7	0.782	179.2
1100	0.822	166.4	2.11	33.3	0.019	-22.4	0.789	178.2
1150	0.826	164.9	1.99	30.8	0.018	-21.4	0.795	177.4
1200	0.832	163.5	1.88	28.6	0.017	-20.4	0.799	176.6
1250	0.839	162.1	1.78	26.4	0.017	-20.1	0.807	175.6
1300	0.842	160.6	1.69	24.3	0.016	-19.0	0.813	174.9
1350	0.845	159.2	1.60	22.0	0.015	-16.8	0.818	173.9
1400	0.849	157.9	1.51	19.7	0.015	-14.5	0.823	173.0
1450	0.852	156.7	1.44	17.6	0.015	-11.8	0.827	171.9
1500	0.856	155.1	1.37	15.8	0.014	-10.4	0.833	171.1
1550	0.860	153.9	1.31	13.7	0.014	-9.1	0.835	170.1
1600	0.859	152.4	1.24	11.4	0.013	-5.6	0.843	169.3
1650	0.862	150.9	1.19	9.5	0.013	-2.5	0.845	168.5
1700	0.866	149.5	1.14	7.8	0.013	0.9	0.852	167.5
1750	0.871	148.1	1.09	6.0	0.013	4.6	0.853	166.5
1800	0.871	146.9	1.04	3.9	0.013	7.8	0.858	165.6
1850	0.874	145.4	1.00	1.9	0.013	8.6	0.862	164.5
1900	0.880	143.8	0.96	0.4	0.013	12.6	0.865	163.6
1950	0.885	142.9	0.92	-1.3	0.014	14.1	0.869	162.8
2000	0.878	141.5	0.89	-3.0	0.014	18.2	0.870	161.8

S Parameter

 $(V_{DS} = 4.8 \text{ V}, I_D = 150 \text{ mA}, Z_o = 50 \Omega)$

f (MHz)	S11		S21		S12		S22	
	MAG	ANG (deg.)	MAG	ANG (deg.)	MAG	ANG (deg.)	MAG	ANG (deg.)
100	0.817	-117.8	24.62	112.3	0.029	24.4	0.638	-132.7
150	0.790	-137.0	17.81	100.8	0.030	13.8	0.656	-147.7
200	0.774	-148.7	13.72	92.8	0.031	7.2	0.670	-155.1
250	0.768	-156.0	11.08	86.9	0.031	3.0	0.675	-160.1
300	0.767	-161.3	9.30	82.3	0.031	-1.0	0.681	-163.6
350	0.766	-165.5	7.93	77.8	0.031	-4.3	0.686	-165.6
400	0.767	-168.6	6.89	74.1	0.030	-6.5	0.691	-167.5
450	0.770	-171.3	6.09	70.4	0.029	-8.7	0.695	-169.1
500	0.776	-173.7	5.45	67.0	0.029	-10.7	0.705	-170.4
550	0.780	-175.9	4.91	63.6	0.028	-13.2	0.712	-171.5
600	0.780	-177.8	4.44	60.3	0.027	-14.9	0.715	-172.3
650	0.786	-179.6	4.07	57.4	0.027	-16.1	0.723	-173.3
700	0.790	178.6	3.74	54.5	0.026	-17.7	0.731	-174.4
750	0.792	177.2	3.44	51.7	0.025	-19.8	0.735	-175.3
800	0.796	175.6	3.18	48.7	0.024	-20.2	0.743	-176.0
850	0.803	174.1	2.95	46.0	0.023	-21.0	0.751	-177.1
900	0.805	172.4	2.76	43.3	0.022	-20.9	0.758	-178.1
950	0.809	170.9	2.57	40.7	0.021	-21.9	0.766	-178.9
1000	0.814	169.3	2.41	38.3	0.021	-22.6	0.773	-179.6
1050	0.817	167.9	2.26	35.8	0.020	-22.3	0.779	179.5
1100	0.823	166.5	2.13	33.4	0.019	-23.0	0.785	178.5
1150	0.827	164.9	2.01	31.0	0.018	-21.1	0.792	177.7
1200	0.833	163.6	1.90	28.7	0.017	-20.5	0.798	177.0
1250	0.838	162.2	1.79	26.4	0.017	-20.0	0.804	176.0
1300	0.842	160.7	1.70	24.2	0.016	-18.2	0.809	175.1
1350	0.847	159.2	1.61	22.0	0.015	-16.4	0.815	174.1
1400	0.851	158.0	1.53	19.8	0.015	-16.9	0.821	173.3
1450	0.853	156.6	1.46	17.7	0.014	-14.5	0.825	172.3
1500	0.857	155.3	1.38	15.7	0.014	-10.1	0.832	171.3
1550	0.859	154.0	1.31	13.6	0.013	-8.5	0.834	170.4
1600	0.861	152.5	1.26	11.6	0.013	-6.4	0.841	169.5
1650	0.862	151.0	1.20	9.6	0.013	-2.9	0.844	168.6
1700	0.866	149.5	1.14	7.6	0.013	1.0	0.849	167.9
1750	0.872	148.2	1.09	5.8	0.013	2.1	0.851	166.8
1800	0.872	146.9	1.05	3.9	0.013	6.9	0.856	165.9
1850	0.871	145.4	1.01	2.1	0.013	10.0	0.860	164.8
1900	0.878	143.6	0.97	0.5	0.013	11.8	0.861	163.9
1950	0.887	143.0	0.93	-1.4	0.014	14.5	0.868	163.0
2000	0.875	141.7	0.89	-3.1	0.014	16.0	0.869	162.0

S Parameter

(V_{DS} = 6.0 V, I_D = 150 mA, Z_o = 50 Ω)

f (MHz)	S11		S21		S12		S22	
	MAG	ANG (deg.)	MAG	ANG (deg.)	MAG	ANG (deg.)	MAG	ANG (deg.)
100	0.830	-115.6	25.26	113.7	0.028	25.3	0.617	-131.4
150	0.798	-135.1	18.30	102.0	0.030	15.1	0.640	-146.7
200	0.784	-147.1	14.13	93.9	0.030	8.0	0.658	-154.6
250	0.777	-155.2	11.45	87.8	0.031	4.1	0.662	-159.5
300	0.774	-160.2	9.60	83.2	0.030	-0.3	0.670	-163.0
350	0.772	-164.7	8.19	78.7	0.030	-3.3	0.674	-165.3
400	0.774	-168.0	7.13	75.0	0.030	-6.0	0.678	-166.9
450	0.776	-170.8	6.30	71.3	0.029	-8.1	0.685	-168.5
500	0.780	-173.4	5.64	67.8	0.028	-9.5	0.693	-170.0
550	0.784	-175.6	5.08	64.4	0.028	-11.9	0.699	-171.0
600	0.787	-177.6	4.62	61.3	0.027	-13.7	0.705	-171.8
650	0.789	-179.3	4.22	58.3	0.026	-15.3	0.711	-173.0
700	0.793	178.9	3.87	55.3	0.025	-16.6	0.720	-173.9
750	0.797	177.2	3.57	52.5	0.025	-17.6	0.726	-175.0
800	0.799	175.6	3.32	49.7	0.024	-18.7	0.733	-175.6
850	0.806	174.2	3.07	46.9	0.023	-20.1	0.740	-176.6
900	0.805	172.6	2.87	44.2	0.022	-20.2	0.747	-177.5
950	0.813	170.9	2.68	41.7	0.021	-20.7	0.755	-178.5
1000	0.816	169.2	2.52	39.3	0.021	-21.1	0.763	-179.1
1050	0.821	167.9	2.37	36.8	0.020	-21.8	0.769	-180.0
1100	0.824	166.5	2.22	34.3	0.019	-21.1	0.775	179.0
1150	0.828	165.0	2.10	31.9	0.018	-20.6	0.782	178.1
1200	0.833	163.6	1.98	29.6	0.018	-20.0	0.788	177.5
1250	0.838	162.2	1.88	27.4	0.016	-19.3	0.795	176.6
1300	0.843	160.7	1.77	25.1	0.016	-18.3	0.800	175.6
1350	0.847	159.2	1.68	22.9	0.015	-17.1	0.806	174.6
1400	0.850	157.9	1.60	20.7	0.015	-15.2	0.811	173.8
1450	0.853	156.7	1.53	18.6	0.015	-12.6	0.815	172.8
1500	0.855	155.3	1.45	16.7	0.014	-11.3	0.821	171.9
1550	0.859	153.9	1.38	14.4	0.014	-7.8	0.826	170.9
1600	0.861	152.5	1.32	12.4	0.013	-4.2	0.831	170.1
1650	0.861	151.0	1.26	10.4	0.013	-1.6	0.835	169.3
1700	0.866	149.5	1.21	8.7	0.013	0.3	0.841	168.4
1750	0.871	148.2	1.15	6.7	0.013	3.4	0.842	167.4
1800	0.871	147.0	1.10	4.7	0.013	6.6	0.847	166.4
1850	0.873	145.3	1.06	2.9	0.013	9.4	0.852	165.3
1900	0.879	143.6	1.02	1.3	0.013	12.4	0.855	164.4
1950	0.886	143.1	0.98	-0.4	0.013	15.4	0.861	163.6
2000	0.877	141.6	0.94	-2.3	0.014	16.4	0.860	162.6

S Parameter

 $(V_{DS} = 7.5 \text{ V}, I_D = 150 \text{ mA}, Z_o = 50 \Omega)$

f (MHz)	S11		S21		S12		S22	
	MAG	ANG (deg.)	MAG	ANG (deg.)	MAG	ANG (deg.)	MAG	ANG (deg.)
100	0.841	-111.8	25.75	115.8	0.026	28.7	0.585	-131.9
150	0.812	-132.4	18.83	103.8	0.029	17.3	0.619	-146.9
200	0.796	-144.8	14.58	95.5	0.030	9.9	0.640	-154.4
250	0.788	-152.9	11.81	89.3	0.029	5.7	0.648	-159.5
300	0.787	-158.7	9.93	84.7	0.029	1.6	0.657	-163.0
350	0.785	-163.4	8.48	80.1	0.029	-1.6	0.661	-165.1
400	0.784	-166.7	7.38	76.3	0.028	-3.7	0.667	-166.9
450	0.785	-170.0	6.53	72.7	0.028	-5.7	0.673	-168.6
500	0.791	-172.6	5.85	69.2	0.027	-7.9	0.681	-169.8
550	0.793	-174.9	5.27	65.7	0.027	-10.3	0.689	-170.9
600	0.793	-177.0	4.79	62.5	0.026	-11.3	0.693	-171.9
650	0.798	-178.9	4.39	59.7	0.025	-14.0	0.697	-172.9
700	0.801	179.1	4.04	56.8	0.025	-14.4	0.708	-173.8
750	0.803	177.5	3.73	54.0	0.024	-15.2	0.714	-174.7
800	0.805	175.9	3.45	51.0	0.023	-16.6	0.720	-175.3
850	0.812	174.3	3.21	48.4	0.022	-16.5	0.727	-176.6
900	0.810	172.6	3.00	45.7	0.022	-17.6	0.734	-177.2
950	0.816	171.1	2.80	43.1	0.021	-18.6	0.744	-178.0
1000	0.819	169.6	2.63	40.6	0.020	-18.2	0.749	-178.9
1050	0.823	168.0	2.47	38.2	0.020	-17.6	0.757	-179.8
1100	0.826	166.6	2.33	35.8	0.019	-18.2	0.762	179.4
1150	0.832	164.9	2.20	33.4	0.018	-18.2	0.768	178.6
1200	0.836	163.7	2.08	31.0	0.018	-16.9	0.776	177.8
1250	0.842	162.3	1.97	28.8	0.017	-17.1	0.782	176.9
1300	0.844	160.7	1.87	26.6	0.016	-15.5	0.787	176.0
1350	0.847	159.2	1.78	24.4	0.016	-13.9	0.793	175.0
1400	0.852	157.8	1.69	22.2	0.015	-12.7	0.801	174.2
1450	0.854	156.7	1.61	19.9	0.015	-10.9	0.804	173.3
1500	0.858	155.3	1.53	18.0	0.014	-7.8	0.809	172.3
1550	0.859	154.0	1.46	15.9	0.014	-6.5	0.814	171.3
1600	0.861	152.5	1.40	13.9	0.014	-3.4	0.820	170.6
1650	0.862	151.0	1.33	11.7	0.013	-0.8	0.825	169.6
1700	0.866	149.5	1.27	9.9	0.014	2.2	0.831	168.9
1750	0.871	148.1	1.22	8.1	0.013	5.1	0.833	167.8
1800	0.871	147.0	1.17	6.1	0.014	8.0	0.837	167.0
1850	0.873	145.4	1.13	4.2	0.014	10.6	0.844	165.9
1900	0.879	143.6	1.08	2.5	0.014	13.1	0.847	164.9
1950	0.886	143.0	1.04	0.7	0.014	14.0	0.851	164.0
2000	0.874	141.7	1.00	-1.1	0.014	16.6	0.851	163.1

Package Dimensions

Package Name	JEITA Package Code	RENESAS Code	Previous Code	MASS[Typ.]	Unit: mm
UPAK	SC-62	PLZZ0004CA-A	UPAK / UPAKV	0.050g	

The drawing shows three views of the package:

- Top View:** Overall width is 4.5 ± 0.1 mm. The distance between the two leads is 1.8 Max mm. The lead width is 0.53 Max mm. The lead thickness is 0.48 Max mm. The lead length is 1.5 mm. The distance between the lead centers is 3.0 mm. The diameter of the central hole is $\phi 1$ mm. The total height of the package is 4.25 Max mm. The distance from the top surface to the lead top is 0.4 mm. The distance from the bottom surface to the lead bottom is 0.8 Min mm.
- Side View:** The total height is 1.5 ± 0.1 mm. The lead height is 0.44 Max mm. The lead thickness is 0.44 Max mm.
- Bottom View:** The lead width is (1.5) mm. The lead thickness is (0.4) mm. The lead length is (0.2) mm.

Recommended Soldering Conditions

This product should be soldered and mounted under the following recommended conditions.

For soldering methods and conditions other than those recommended below, contact your nearby sales office.

Method	Item	Conditions
Partial Heating	Peak temperature (terminal temperature)	350°C or below
	Soldering time (per side of device)	3 seconds or less
Infrared Reflow	Peak temperature (package surface temperature)	260°C or below
	Time at peak temperature	10 seconds or less
	Time at temperature of 230°C or higher	15 to 50 seconds or less
	Preheating time at 150 to 180°C	60 to 300 seconds
	Maximum number of reflow processes	Twice

Ordering Information

Part Name	Quantity	Shipping Container
RQA0010VXDQSTL-E	1000 pcs	ϕ 178 mm reel, 12 mm emboss taping

Notes:

1. This document is provided for reference purposes only so that Renesas customers may select the appropriate Renesas products for their use. Renesas neither makes warranties or representations with respect to the accuracy or completeness of the information contained in this document nor grants any license to any intellectual property rights or any other rights of Renesas or any third party with respect to the information in this document.
2. Renesas shall have no liability for damages or infringement of any intellectual property or other rights arising out of the use of any information in this document, including, but not limited to, product data, diagrams, charts, programs, algorithms, and application circuit examples.
3. You should not use the products or the technology described in this document for the purpose of military applications such as the development of weapons of mass destruction or for the purpose of any other military use. When exporting the products or technology described herein, you should follow the applicable export control laws and regulations, and procedures required by such laws and regulations.
4. All information included in this document such as product data, diagrams, charts, programs, algorithms, and application circuit examples, is current as of the date this document is issued. Such information, however, is subject to change without any prior notice. Before purchasing or using any Renesas products listed in this document, please confirm the latest product information with a Renesas sales office. Also, please pay regular and careful attention to additional and different information to be disclosed by Renesas such as that disclosed through our website. (<http://www.renesas.com>)
5. Renesas has used reasonable care in compiling the information included in this document, but Renesas assumes no liability whatsoever for any damages incurred as a result of errors or omissions in the information included in this document.
6. When using or otherwise relying on the information in this document, you should evaluate the information in light of the total system before deciding about the applicability of such information to the intended application. Renesas makes no representations, warranties or guarantees regarding the suitability of its products for any particular application and specifically disclaims any liability arising out of the application and use of the information in this document or Renesas products.
7. With the exception of products specified by Renesas as suitable for automobile applications, Renesas products are not designed, manufactured or tested for applications or otherwise in systems the failure or malfunction of which may cause a direct threat to human life or create a risk of human injury or which require especially high quality and reliability such as safety systems, or equipment or systems for transportation and traffic, healthcare, combustion control, aerospace and aeronautics, nuclear power, or undersea communication transmission. If you are considering the use of our products for such purposes, please contact a Renesas sales office beforehand. Renesas shall have no liability for damages arising out of the uses set forth above.
8. Notwithstanding the preceding paragraph, you should not use Renesas products for the purposes listed below:
 - (1) artificial life support devices or systems
 - (2) surgical implantations
 - (3) healthcare intervention (e.g., excision, administration of medication, etc.)
 - (4) any other purposes that pose a direct threat to human lifeRenesas shall have no liability for damages arising out of the uses set forth in the above and purchasers who elect to use Renesas products in any of the foregoing applications shall indemnify and hold harmless Renesas Technology Corp., its affiliated companies and their officers, directors, and employees against any and all damages arising out of such applications.
9. You should use the products described herein within the range specified by Renesas, especially with respect to the maximum rating, operating supply voltage range, movement power voltage range, heat radiation characteristics, installation and other product characteristics. Renesas shall have no liability for malfunctions or damages arising out of the use of Renesas products beyond such specified ranges.
10. Although Renesas endeavors to improve the quality and reliability of its products, IC products have specific characteristics such as the occurrence of failure at a certain rate and malfunctions under certain use conditions. Please be sure to implement safety measures to guard against the possibility of physical injury, and injury or damage caused by fire in the event of the failure of a Renesas product, such as safety design for hardware and software including but not limited to redundancy, fire control and malfunction prevention, appropriate treatment for aging degradation or any other applicable measures. Among others, since the evaluation of microcomputer software alone is very difficult, please evaluate the safety of the final products or system manufactured by you.
11. In case Renesas products listed in this document are detached from the products to which the Renesas products are attached or affixed, the risk of accident such as swallowing by infants and small children is very high. You should implement safety measures so that Renesas products may not be easily detached from your products. Renesas shall have no liability for damages arising out of such detachment.
12. This document may not be reproduced or duplicated, in any form, in whole or in part, without prior written approval from Renesas.
13. Please contact a Renesas sales office if you have any questions regarding the information contained in this document, Renesas semiconductor products, or if you have any other inquiries.



RENESAS SALES OFFICES

<http://www.renesas.com>

Refer to "<http://www.renesas.com/en/network>" for the latest and detailed information.

Renesas Technology America, Inc.
450 Holger Way, San Jose, CA 95134-1368, U.S.A
Tel: <1> (408) 382-7500, Fax: <1> (408) 382-7501

Renesas Technology Europe Limited
Dukes Meadow, Millboard Road, Bourne End, Buckinghamshire, SL8 5FH, U.K.
Tel: <44> (1628) 585-100, Fax: <44> (1628) 585-900

Renesas Technology (Shanghai) Co., Ltd.
Unit 204, 205, AZIACenter, No.1233 Lujiazui Ring Rd, Pudong District, Shanghai, China 200120
Tel: <86> (21) 5877-1818, Fax: <86> (21) 6887-7858/7898

Renesas Technology Hong Kong Ltd.
7th Floor, North Tower, World Finance Centre, Harbour City, Canton Road, Tsimshatsui, Kowloon, Hong Kong
Tel: <852> 2265-6688, Fax: <852> 2377-3473

Renesas Technology Taiwan Co., Ltd.
10th Floor, No.99, Fushing North Road, Taipei, Taiwan
Tel: <886> (2) 2715-2888, Fax: <886> (2) 3518-3399

Renesas Technology Singapore Pte. Ltd.
1 Harbour Front Avenue, #06-10, Keppel Bay Tower, Singapore 098632
Tel: <65> 6213-0200, Fax: <65> 6278-8001

Renesas Technology Korea Co., Ltd.
Kukje Center Bldg. 18th Fl., 191, 2-ka, Hangang-ro, Yongsan-ku, Seoul 140-702, Korea
Tel: <82> (2) 796-3115, Fax: <82> (2) 796-2145

Renesas Technology Malaysia Sdn. Bhd
Unit 906, Block B, Menara Amcorp, Amcorp Trade Centre, No.18, Jln Persiaran Barat, 46050 Petaling Jaya, Selangor Darul Ehsan, Malaysia
Tel: <603> 7955-9390, Fax: <603> 7955-9510