

N-Channel 20 V (D-S) MOSFET

| PRODUCT SUMMARY | | | |
|---------------------|----------------------------------|---------------------------------|-----------------------|
| V _{DS} (V) | R _{DS(on)} (Ω) MAX. | I _D (A) ^a | Q _g (TYP.) |
| 20 | 0.037 at V _{GS} = 4.5 V | 5.7 | 5.9 nC |
| | 0.041 at V _{GS} = 2.5 V | 5.4 | |
| | 0.047 at V _{GS} = 1.8 V | 5.0 | |
| | 0.068 at V _{GS} = 1.5 V | 4.2 | |

FEATURES

- TrenchFET[®] power MOSFET
- Ultra small 1 mm x 1 mm maximum outline
- Ultra-thin 0.54 mm maximum height
- Material categorization:
For definitions of compliance please see www.vishay.com/doc?99912



RoHS
COMPLIANT
HALOGEN
FREE

MICRO FOOT[®] 1 x 1

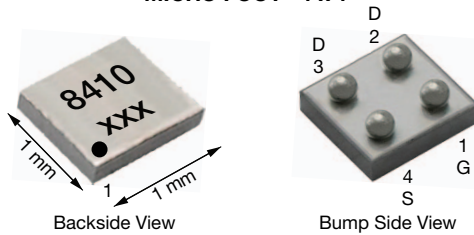

Marking Code: 8410

Ordering Information:

Si8410DB-T2-E1 (Lead (Pb)-free and Halogen-free)

APPLICATIONS

- Load switch
- Power management
- High speed switching

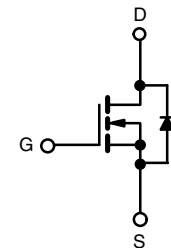

N-Channel MOSFET

| ABSOLUTE MAXIMUM RATINGS (T _A = 25 °C, unless otherwise noted) | | | |
|---|-----------------------------------|------------------------|-------------------|
| PARAMETER | SYMBOL | LIMIT | UNIT |
| Drain-Source Voltage | V _{DS} | 20 | V |
| Gate-Source Voltage | V _{GS} | ± 8 | |
| Continuous Drain Current (T _J = 150 °C) | I _D | T _A = 25 °C | 5.7 ^a |
| | | T _A = 70 °C | 4.5 ^a |
| | | T _A = 25 °C | 3.8 ^c |
| | | T _A = 70 °C | 3.0 ^c |
| Pulsed Drain Current (t = 100 μs) | I _{DM} | 20 | A |
| Continuous Source-Drain Diode Current | I _S | T _C = 25 °C | |
| | | T _A = 25 °C | 0.65 ^c |
| Maximum Power Dissipation | P _D | T _A = 25 °C | 1.8 ^a |
| | | T _A = 70 °C | 1.1 ^a |
| | | T _A = 25 °C | 0.78 ^c |
| | | T _A = 70 °C | 0.5 ^c |
| Operating Junction and Storage Temperature Range | T _J , T _{stg} | -55 to 150 | °C |
| Package Reflow Conditions ^e | VPR | 260 | |
| | IR/Convection | 260 | |

| THERMAL RESISTANCE RATINGS | | | | | |
|---|----------|-------------------|---------|---------|------|
| PARAMETER | | SYMBOL | TYPICAL | MAXIMUM | UNIT |
| Maximum Junction-to-Ambient ^{a, b} | t = 10 s | R _{thJA} | 55 | 70 | °C/W |
| Maximum Junction-to-Ambient ^{c, d} | t = 10 s | | 125 | 160 | |

Notes

- Surface mounted on 1" x 1" FR4 board with full copper, t = 10 s, T_A = 25 °C.
- Maximum under steady state conditions is 100 °C/W.
- Surface mounted on 1" x 1" FR4 board with minimum copper, t = 10 s.
- Maximum under steady state conditions is 190 °C/W.
- Refer to IPC/JEDEC[®] (J-STD-020), no manual or hand soldering.
- In this document, any reference to case represents the body of the MICRO FOOT device and foot is the bump.



| SPECIFICATIONS (T _J = 25 °C, unless otherwise noted) | | | | | | |
|---|--------------------------------------|--|------|-------|-------|-------|
| PARAMETER | SYMBOL | TEST CONDITIONS | MIN. | TYP. | MAX. | UNIT |
| Static | | | | | | |
| Drain-Source Breakdown Voltage | V _{DS} | V _{GS} = 0 V, I _D = 250 μA | 20 | - | - | V |
| V _{DS} Temperature Coefficient | ΔV _{DS} /T _J | I _D = 250 μA | - | 17 | - | mV/°C |
| V _{GS(th)} Temperature Coefficient | ΔV _{GS(th)} /T _J | | - | -2.6 | - | |
| Gate-Source Threshold Voltage | V _{GS(th)} | V _{DS} = V _{GS} , I _D = 250 μA | 0.4 | - | 0.85 | V |
| Gate-Source Leakage | I _{GSS} | V _{DS} = 0 V, V _{GS} = ± 8 V | - | - | ± 100 | nA |
| Zero Gate Voltage Drain Current | I _{DSS} | V _{DS} = 20 V, V _{GS} = 0 V | - | - | 1 | μA |
| | | V _{DS} = 20 V, V _{GS} = 0 V, T _J = 70 °C | - | - | 10 | |
| On-State Drain Current ^a | I _{D(on)} | V _{DS} ≤ -5 V, V _{GS} = 4.5 V | 10 | - | - | A |
| Drain-Source On-State Resistance ^a | R _{DS(on)} | V _{GS} = 4.5 V, I _D = 1.5 A | - | 0.030 | 0.037 | Ω |
| | | V _{GS} = 2.5 V, I _D = 1 A | - | 0.033 | 0.041 | |
| | | V _{GS} = 1.8 V, I _D = 1 A | - | 0.038 | 0.047 | |
| | | V _{GS} = 1.5 V, I _D = 0.5 A | - | 0.044 | 0.068 | |
| Forward Transconductance ^a | g _{fs} | V _{DS} = 10 V, I _D = 1.5 A | - | 17 | - | S |
| Dynamic ^b | | | | | | |
| Input Capacitance | C _{ISS} | V _{DS} = 10 V, V _{GS} = 0 V, f = 1 MHz | - | 620 | - | pF |
| Output Capacitance | C _{OSS} | | - | 110 | - | |
| Reverse Transfer Capacitance | C _{RSS} | | - | 40 | - | |
| Total Gate Charge | Q _g | V _{DS} = 10 V, V _{GS} = 8 V, I _D = 1.5 A | - | 10.4 | 16 | nC |
| | | V _{DS} = 10 V, V _{GS} = 4.5 V, I _D = 1.5 A | - | 5.9 | 9 | |
| Gate-Source Charge | Q _{gs} | | - | 0.7 | - | |
| Gate-Drain Charge | Q _{gd} | | - | 0.66 | - | |
| Gate Resistance | R _g | V _{GS} = 0.1 V, f = 1 MHz | - | 5.3 | - | Ω |
| Turn-On Delay Time | t _{d(on)} | V _{DD} = -10 V, R _L = 6.7 Ω I _D ≅ 1.5 A, V _{GEN} = -4.5 V, R _g = 1 Ω | - | 5 | 10 | ns |
| Rise Time | t _r | | - | 25 | 50 | |
| Turn-Off Delay Time | t _{d(off)} | | - | 26 | 50 | |
| Fall Time | t _f | | - | 10 | 20 | |
| Turn-On Delay Time | t _{d(on)} | V _{DD} = -10 V, R _L = 6.7 Ω I _D ≅ -1.5 A, V _{GEN} = -8 V, R _g = 1 Ω | - | 5 | 10 | |
| Rise Time | t _r | | - | 22 | 45 | |
| Turn-Off Delay Time | t _{d(off)} | | - | 23 | 45 | |
| Fall Time | t _f | | - | 10 | 20 | |
| Drain-Source Body Diode Characteristics | | | | | | |
| Continuous Source-Drain Diode Current | I _S | T _A = 25 °C | - | - | 1.5 | A |
| Pulse Diode Forward Current | I _{SM} | | - | - | 20 | |
| Body Diode Voltage | V _{SD} | I _S = 1.5 A, V _{GS} = 0 | - | 0.7 | 1.2 | V |
| Body Diode Reverse Recovery Time | t _{rr} | I _F = 1.5 A, dI/dt = 100 A/μs, T _J = 25 °C | - | 15 | 30 | ns |
| Body Diode Reverse Recovery Charge | Q _{rr} | | - | 6 | 15 | nC |
| Reverse Recovery Fall Time | t _a | | - | 8.5 | - | ns |
| Reverse Recovery Rise Time | t _b | | - | 6.5 | - | |

Notes

- a. Pulse test; pulse width ≤ 300 μs, duty cycle ≤ 2 %.
- b. Guaranteed by design, not subject to production testing.

Stresses beyond those listed under "Absolute Maximum Ratings" may cause permanent damage to the device. These are stress ratings only, and functional operation of the device at these or any other conditions beyond those indicated in the operational sections of the specifications is not implied. Exposure to absolute maximum rating conditions for extended periods may affect device reliability.



TYPICAL CHARACTERISTICS (25 °C, unless otherwise noted)

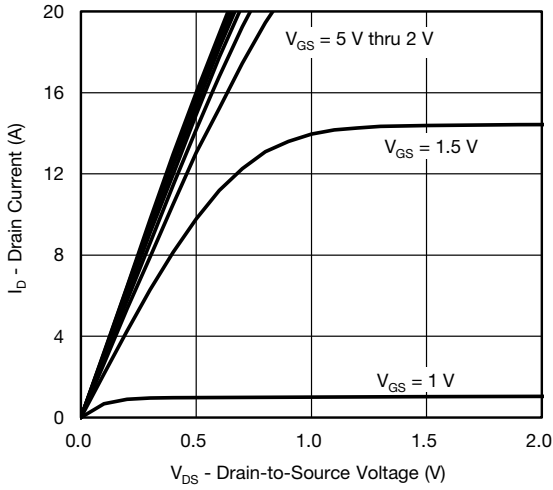

Output Characteristics

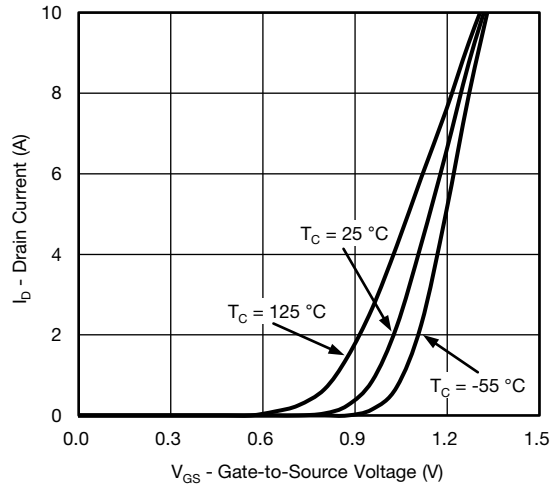

Transfer Characteristics

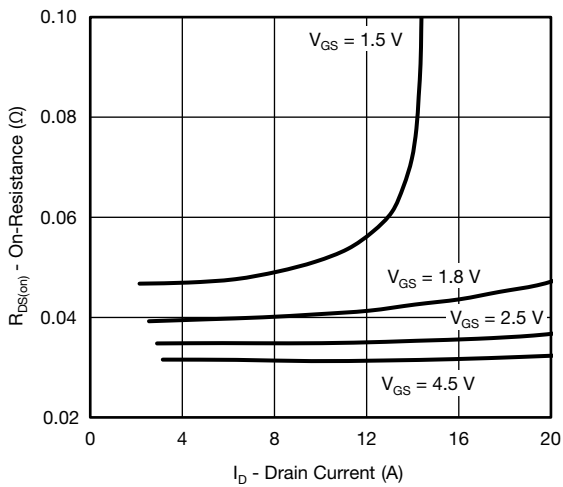

On-Resistance vs. Drain Current and Gate Voltage

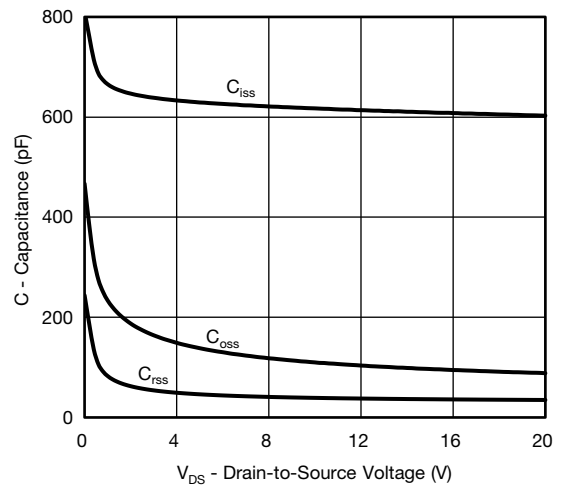

Capacitance

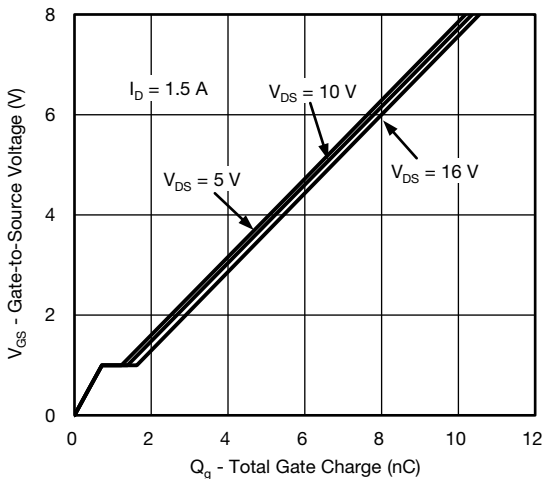

Gate Charge

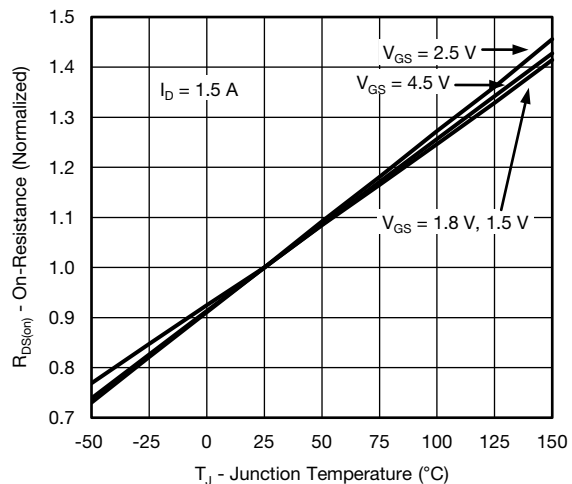

On-Resistance vs. Junction Temperature

TYPICAL CHARACTERISTICS (25 °C, unless otherwise noted)

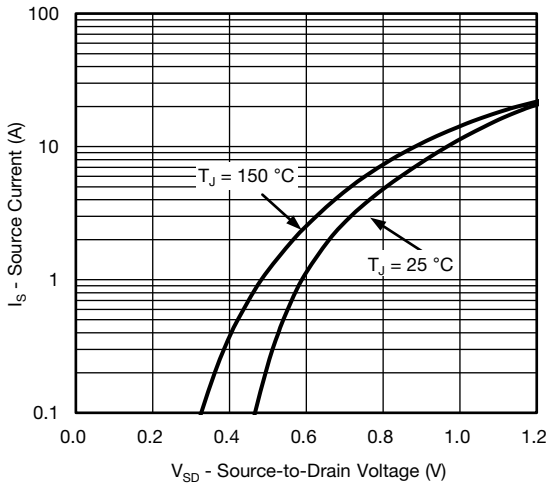

Source-Drain Diode Forward Voltage

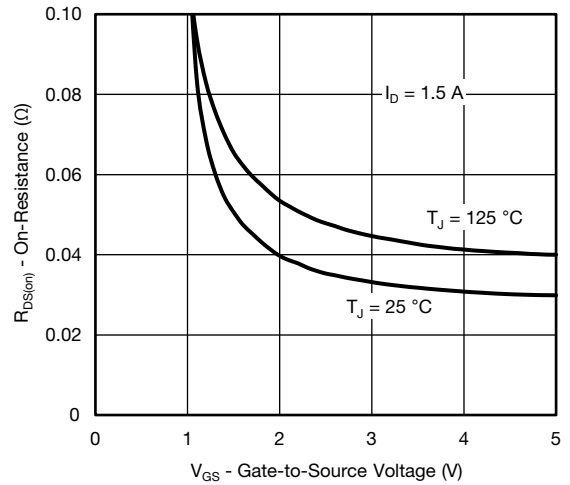

On-Resistance vs. Gate-to-Source Voltage

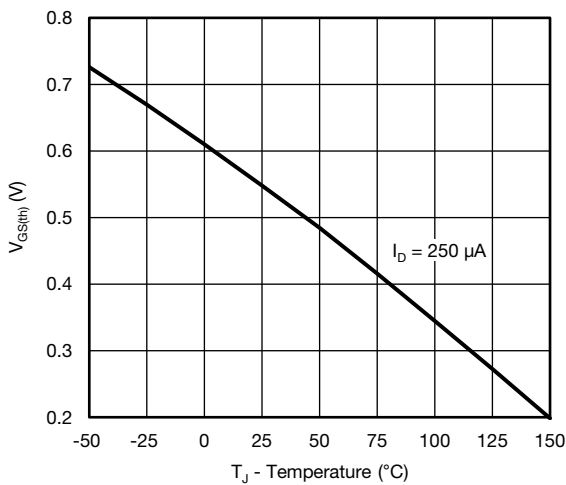

Threshold Voltage

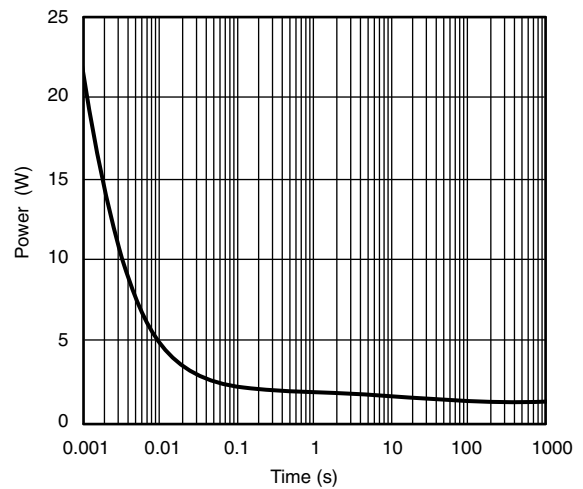

Single Pulse Power, Junction-to-Ambient

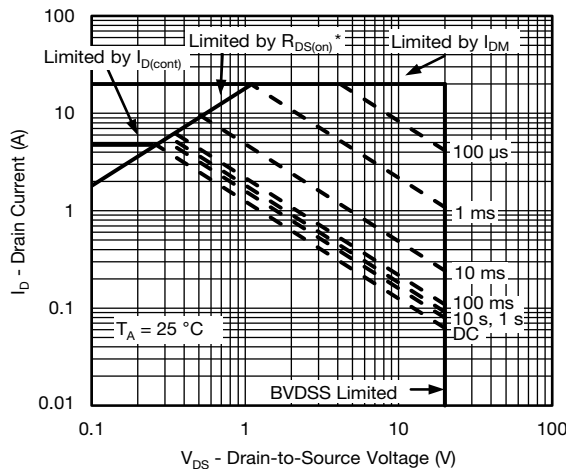

* $V_{GS} >$ minimum V_{GS} at which $R_{DS(on)}$ is specified

Safe Operating Area, Junction-to-Ambient



TYPICAL CHARACTERISTICS (25 °C, unless otherwise noted)

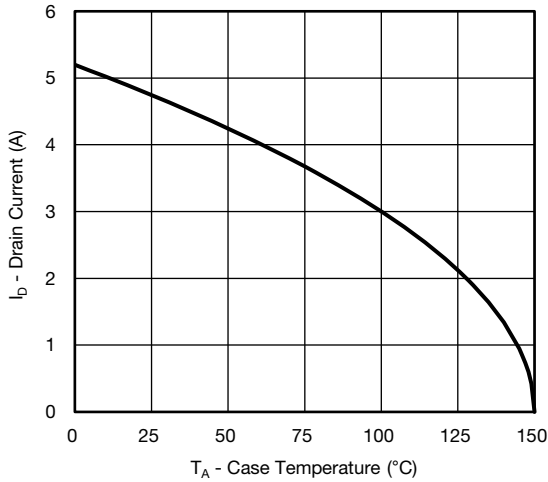

Current Derating*

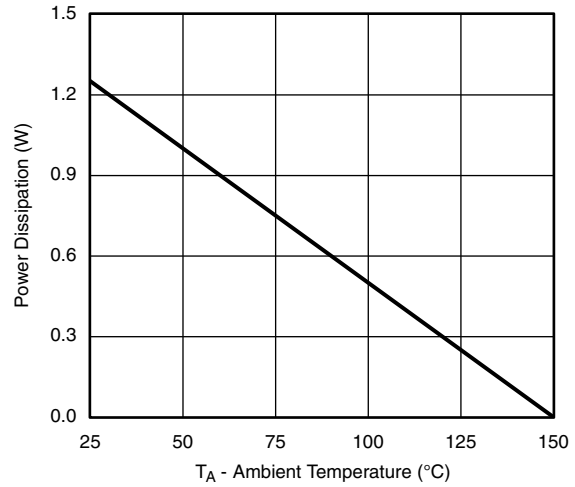

Power Derating

Note

- When mounted on 1" x 1" FR4 with full copper.

* The power dissipation P_D is based on $T_{J(max)} = 150\text{ °C}$, using junction-to-case thermal resistance, and is more useful in settling the upper dissipation limit for cases where additional heatsinking is used. It is used to determine the current rating, when this rating falls below the package limit.



TYPICAL CHARACTERISTICS (25 °C, unless otherwise noted)

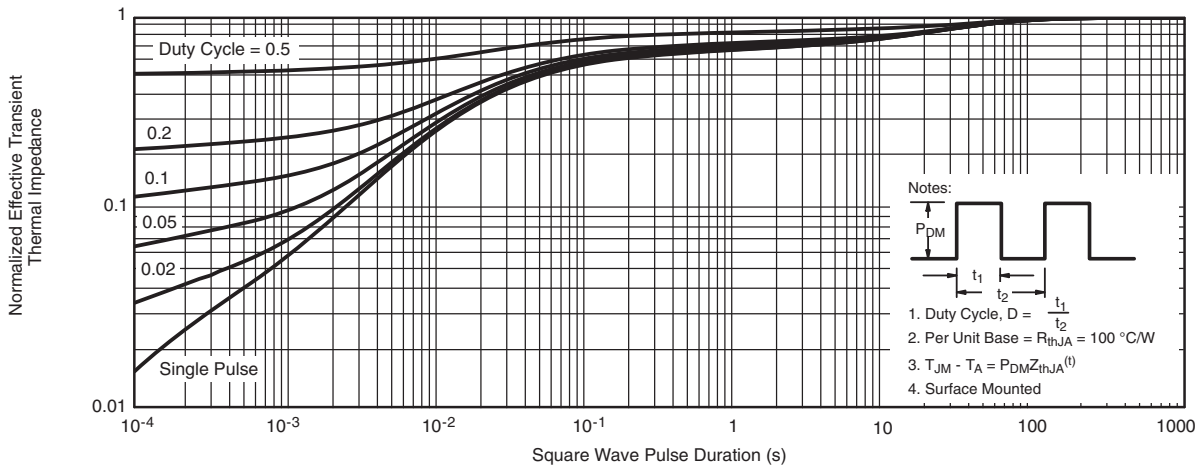

Normalized Thermal Transient Impedance, Junction-to-Ambient (1" x 1" FR4 Board with Full Copper)

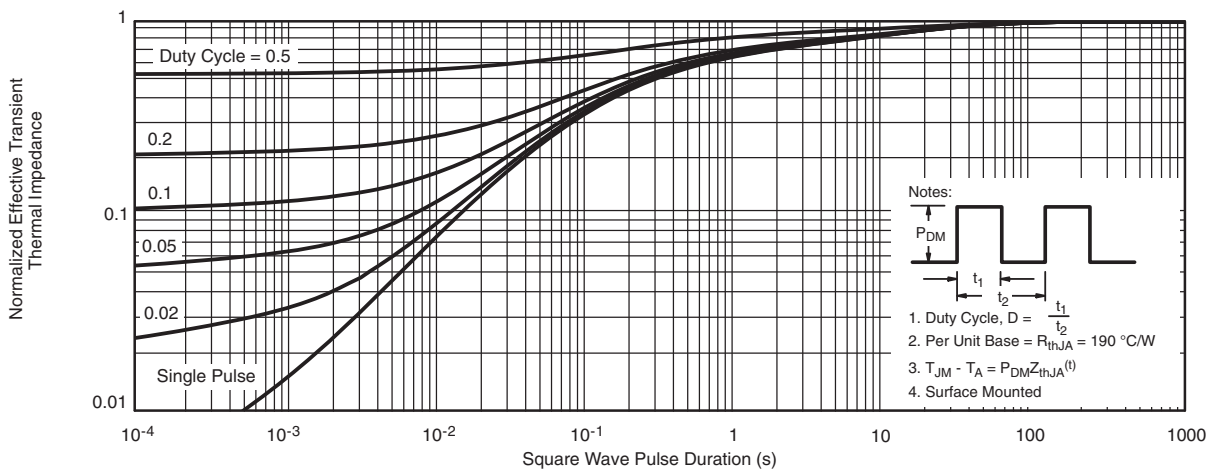

Normalized Thermal Transient Impedance, Junction-to-Ambient (1" x 1" FR4 Board with Minimum Copper)

PACKAGE OUTLINE

MICRO FOOT 1 mm x 1 mm: 4-Bump (0.5 mm pitch)

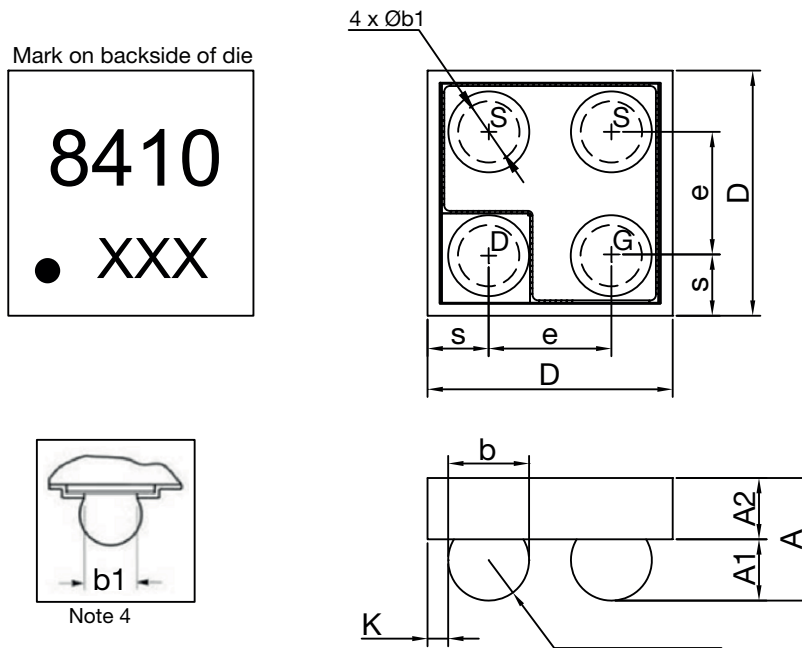

Notes

- (1) Laser mark on the backside surface of die.
- (2) Bumps are 95.5 % Sn, 3.8 % Ag, 0.7 % Cu.
- (3) • is location of pin 1.
- (4) “b1” is the diameter of the solderable substrate surface, defined by an opening in the solder resist layer solder mask defined.
- (5) Non-solder mask defined copper landing pad.

| DIMENSION | MILLIMETERS ^a | | | INCHES | | |
|-----------|--------------------------|---------|---------|---------|---------|---------|
| | MINIMUM | NOMINAL | MAXIMUM | MINIMUM | NOMINAL | MAXIMUM |
| A | 0.460 | 0.500 | 0.540 | 0.0181 | 0.0196 | 0.0212 |
| A1 | 0.214 | 0.250 | 0.286 | 0.0084 | 0.0098 | 0.0112 |
| A2 | 0.244 | 0.254 | 0.264 | 0.0096 | 0.0100 | 0.0104 |
| b | 0.297 | 0.330 | 0.363 | 0.0116 | 0.0129 | 0.0142 |
| b1 | | 0.250 | | | 0.0098 | |
| e | | 0.500 | | | 0.0197 | |
| s | 0.210 | 0.230 | 0.250 | 0.0008 | 0.0090 | 0.0098 |
| D | 0.920 | 0.960 | 1.000 | 0.0362 | 0.0377 | 0.0393 |
| K | 0.028 | 0.065 | 0.101 | 0.0011 | 0.0025 | 0.0039 |

Note

- a. Use millimeters as the primary measurement.

Vishay Siliconix maintains worldwide manufacturing capability. Products may be manufactured at one of several qualified locations. Reliability data for Silicon Technology and Package Reliability represent a composite of all qualified locations. For related documents such as package/tape drawings, part marking, and reliability data, see www.vishay.com/ppg?62961.



Disclaimer

ALL PRODUCT, PRODUCT SPECIFICATIONS AND DATA ARE SUBJECT TO CHANGE WITHOUT NOTICE TO IMPROVE RELIABILITY, FUNCTION OR DESIGN OR OTHERWISE.

Vishay Intertechnology, Inc., its affiliates, agents, and employees, and all persons acting on its or their behalf (collectively, "Vishay"), disclaim any and all liability for any errors, inaccuracies or incompleteness contained in any datasheet or in any other disclosure relating to any product.

Vishay makes no warranty, representation or guarantee regarding the suitability of the products for any particular purpose or the continuing production of any product. To the maximum extent permitted by applicable law, Vishay disclaims (i) any and all liability arising out of the application or use of any product, (ii) any and all liability, including without limitation special, consequential or incidental damages, and (iii) any and all implied warranties, including warranties of fitness for particular purpose, non-infringement and merchantability.

Statements regarding the suitability of products for certain types of applications are based on Vishay's knowledge of typical requirements that are often placed on Vishay products in generic applications. Such statements are not binding statements about the suitability of products for a particular application. It is the customer's responsibility to validate that a particular product with the properties described in the product specification is suitable for use in a particular application. Parameters provided in datasheets and/or specifications may vary in different applications and performance may vary over time. All operating parameters, including typical parameters, must be validated for each customer application by the customer's technical experts. Product specifications do not expand or otherwise modify Vishay's terms and conditions of purchase, including but not limited to the warranty expressed therein.

Except as expressly indicated in writing, Vishay products are not designed for use in medical, life-saving, or life-sustaining applications or for any other application in which the failure of the Vishay product could result in personal injury or death. Customers using or selling Vishay products not expressly indicated for use in such applications do so at their own risk. Please contact authorized Vishay personnel to obtain written terms and conditions regarding products designed for such applications.

No license, express or implied, by estoppel or otherwise, to any intellectual property rights is granted by this document or by any conduct of Vishay. Product names and markings noted herein may be trademarks of their respective owners.

Material Category Policy

Vishay Intertechnology, Inc. hereby certifies that all its products that are identified as RoHS-Compliant fulfill the definitions and restrictions defined under Directive 2011/65/EU of The European Parliament and of the Council of June 8, 2011 on the restriction of the use of certain hazardous substances in electrical and electronic equipment (EEE) - recast, unless otherwise specified as non-compliant.

Please note that some Vishay documentation may still make reference to RoHS Directive 2002/95/EC. We confirm that all the products identified as being compliant to Directive 2002/95/EC conform to Directive 2011/65/EU.

Vishay Intertechnology, Inc. hereby certifies that all its products that are identified as Halogen-Free follow Halogen-Free requirements as per JEDEC JS709A standards. Please note that some Vishay documentation may still make reference to the IEC 61249-2-21 definition. We confirm that all the products identified as being compliant to IEC 61249-2-21 conform to JEDEC JS709A standards.

Mouser Electronics

Authorized Distributor

Click to View Pricing, Inventory, Delivery & Lifecycle Information:

[Vishay:](#)

[Si8410DB-T2-E1](#)