



3.3V 128K×32/36 SRAM with NTD™

Features

- Organization: 131,072 words × 32 or 36 bits NTD™¹ architecture for efficient bus operation
- Fast clock speeds to 166 MHz in LVTTTL/LVCMOS
- Fast clock to data access: 3.5/4.0/5.0 ns
- Fast OE access time: 3.5/4.0/5.0 ns
- Fully synchronous operation
- Flow-through or pipelined mode
- Asynchronous output enable control

- Economical 100-pin TQFP package
- Byte write enables
- Clock enable for operation hold
- Multiple chip enables for easy expansion
- 3.3V core power supply
- 2.5V or 3.3V I/O operation with separate V_{DDQ}
- 30 mW typical standby power
- Self-timed write cycles
- Interleaved or linear burst modes
- Snooze mode for standby operation

1. NTD™ is a trademark of Alliance Semiconductor Corporation.

Logic block diagram

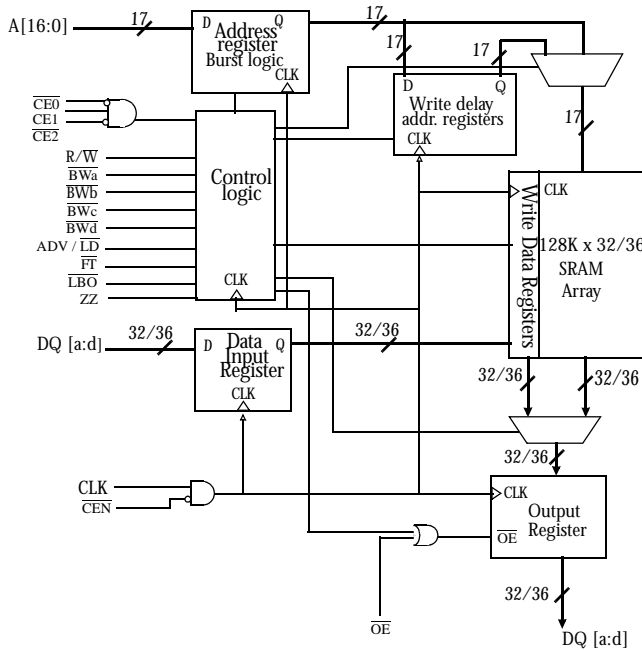

Pin arrangement for TQFP (top view)

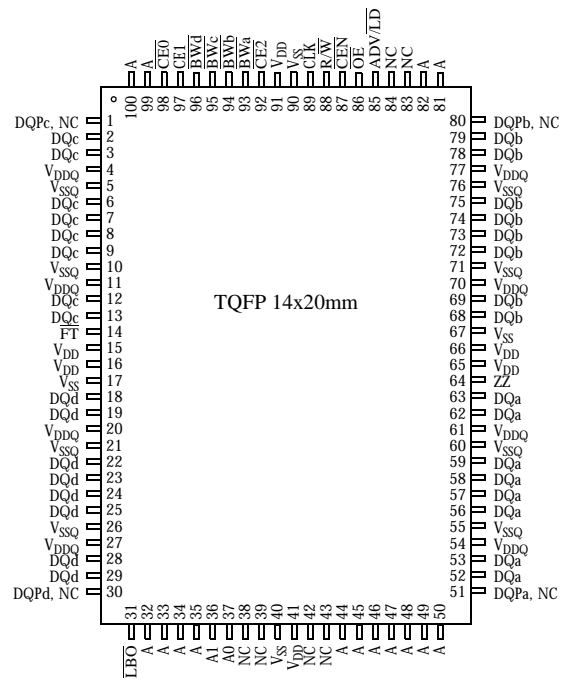

Note: Pins 1,30,51,80 are NC for ×32

Selection Guide

	-166	-133	-100	Units
Minimum cycle time	6	7.5	10	ns
Maximum pipelined clock frequency	166	133	100	MHz
Maximum pipelined clock access time	3.5	4	5	ns
Maximum operating current	475	425	325	mA
Maximum standby current	130	100	90	mA
Maximum CMOS standby current (DC)	30	30	30	mA



Functional description

The AS7C33128NTD36A family is a high performance CMOS 4-Mbit synchronous Static Random Access Memory (SRAM) device organized as 131,072 words \times 32 or 36 bits that incorporates a LATE LATE Write.

This variation of the 4Mb synchronous SRAM uses the No Turnaround Delay (NTD) architecture, featuring an enhanced write operation that improves bandwidth over pipelined burst devices. In a normal pipelined burst device, the write data, command, and address are all applied to the device on the same clock edge. If a read command follows this write command, the system must wait for two dead cycles for valid data to become available. These dead cycles can significantly reduce overall bandwidth for applications requiring random access or read-modify-write operations.

NTD devices use the memory bus more efficiently by introducing a write latency that matches the two-cycle pipelined or one-cycle flow-through read latency. Write data is applied two cycles after the write command and address, allowing the read pipeline to clear. With NTD, write and read operations can be used in any order without producing dead bus cycles.

Assert $\overline{R/\overline{W}}$ low to perform write cycles. Byte write enable controls write access to specific bytes, or can be tied low for full 32/36 bit writes. Write enable signals, along with the write address, are registered on a rising edge of the clock. Write data is applied to the device two clock cycles later. Unlike some asynchronous SRAMs, output enable \overline{OE} does not need to be toggled for write operations. It can be tied low for normal operations. Outputs go to a high impedance state when the device is deselected by any of the three chip enable inputs. (Refer to synchronous truth table on page 4.) In pipelined mode, a two-cycle deselect latency allows pending read or write operations to be completed.

Use the $\overline{ADV/\overline{LD}}$ (burst advance) input to perform burst read, write, and deselect operations. When $\overline{ADV/\overline{LD}}$ is high, external addresses, chip select, and $\overline{R/\overline{W}}$ pins are ignored, and internal address counters increment in the count sequence specified by the LBO control. Any device operations, including burst, can be stalled using the clock enable input, $\overline{CEN} = 1$.

The AS7C33128NTD36A and AS7C33128NTD32A operate with a $3.3V \pm 5\%$ power supply for the device core (V_{DD}). DQ circuits use a separate power supply (V_{DDQ}) that operates across 3.3V or 2.5V ranges. These devices are available in a 100-pin 14 \times 20 mm TQFP package.

Capacitance

Parameter	Symbol	Signals	Test conditions	Max	Unit
Input capacitance	C_{IN}	Address and control pins	$V_{in} = 0V$	5	pF
I/O capacitance	$C_{I/O}$	I/O pins	$V_{in} = V_{out} = 0V$	7	pF

Burst order

	Interleaved burst order LBO = 1				Linear burst order LBO = 0				
Starting address	00	01	10	11	Starting address	00	01	10	11
First increment	01	00	11	10	First increment	01	00	11	10
Second increment	10	11	00	01	Second increment	10	11	00	01
Third increment	11	10	01	10	Third increment	11	10	01	10



Signal descriptions

Signal	I/O	Properties	Description
CLK	I	CLOCK	Clock. All inputs except \overline{OE} , FT, \overline{LBO} , and ZZ are synchronous to this clock.
\overline{CEN}	I	SYNC	Clock enable. When de-asserted high, the clock input signal is masked.
A, A0, A1	I	SYNC	Address. Sampled when all chip enables are active and $\overline{ADV}/\overline{LD}$ is asserted.
DQ[a,b,c,d]	I/O	SYNC	Data. Driven as output when the chip is enabled and \overline{OE} is active.
$\overline{CE0}$, CE1, CE2	I	SYNC	Synchronous chip enables. Sampled at the rising edge of CLK, when $\overline{ADV}/\overline{LD}$ is asserted. Are ignored when $\overline{ADV}/\overline{LD}$ is high.
$\overline{ADV}/\overline{LD}$	I	SYNC	Advance or Load. When sampled high, the internal burst address counter will increment in the order defined by the \overline{LBO} input value. (refer to table on page 2) When low, a new address is loaded.
R/W	I	SYNC	A high during LOAD initiates a READ operation. A low during LOAD initiates a WRITE operation. Is ignored when $\overline{ADV}/\overline{LD}$ is high.
$\overline{BW}[a,\overline{b},c,d]$	I	SYNC	Byte write enables. Used to control write on individual bytes. Sampled along with WRITE command and BURST WRITE.
\overline{OE}	I	ASYNC	Asynchronous output enable. I/O pins are not driven when \overline{OE} is inactive.
\overline{LBO}	I	STATIC	Count mode. When driven high, count sequence follows Intel XOR convention. When driven low, count sequence follows linear convention. This input should be static when the device is in operation.
FT	I	STATIC	Flow-through mode. When low, enables single register flow-through mode. Connect to V_{DD} if unused or for pipelined operation.
ZZ	I	ASYNC	Snooze. Places device in low power mode. Data is retained. Connect to VSS if unused.
NC	-	-	No connects. Note that pin 83 & 84 will be used for future address expansion to 8 Mb and 16Mb density.

Absolute maximum ratings

Parameter	Symbol	Min	Max	Unit
Power supply voltage relative to VSS	V_{DD}, V_{DDQ}	-0.5	+4.6	V
Input voltage relative to VSS (input pins)	V_{IN}	-0.5	$V_{DD} + 0.5$	V
Input voltage relative to VSS (I/O pins)	V_{IN}	-0.5	$V_{DDQ} + 0.5$	V
Power dissipation	P_D	-	1.8	W
DC output current	I_{OUT}	-	50	mA
Storage temperature (plastic)	T_{stg}	-65	+150	°C
Temperature under bias (Junction)	T_{bias}	-65	+135	°C

Stresses greater than those listed under Absolute Maximum Ratings may cause permanent damage to the device. This is a stress rating only and functional operation of the device at these or any other conditions outside those indicated in the operational sections of this specification is not implied. Exposure to absolute maximum rating conditions may affect reliability.



Synchronous truth table

CE0	CE1	CE2	ADV/ LD	R/W	BW[a:d]	OE	CEN	Address source	CLK	Operation
H	X	X	L	X	X	X	L	NA	L to H	Deselect, high-Z
X	L	X	L	X	X	X	L	NA	L to H	Deselect, high-Z
X	X	H	L	X	X	X	L	NA	L to H	Deselect, high-Z
L	H	L	L	H	X	X	L	External	L to H	Begin read
L	H	L	L	L	L	X	L	External	L to H	Begin write
X	X	X	H	X	X ¹	X	L	Burst counter	L to H	Burst ²
X	X	X	X	X	X	X	H	Stall	L to H	Inhibit the CLK

Key: X = don't care, L = low, H = high.

1. Should be low for burst write, unless specific bytes need to be inhibited.

2. Refer to state diagram below.

State Diagram for NTD SRAM

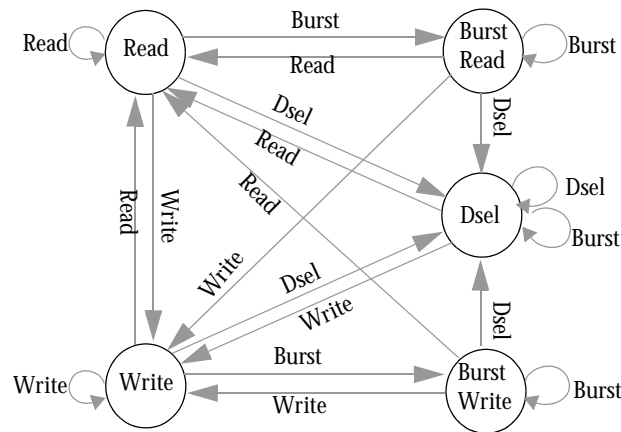

TQFP thermal resistance

Description	Conditions	Symbol	Typical	Units
Thermal resistance (Junction to Ambient) ¹	Test conditions follow standard test methods and procedures for measuring thermal impedance, per EIA/JESD51.	θ_{JA}	40	°C/W
Thermal resistance (Junction to Top of Case) ¹		θ_{JC}	8	°C/W

¹ This parameter is sampled.



Recommended operating conditions

Parameter		Symbol	Min	Nominal	Max	Unit
Supply voltage		V_{DD}	3.135	3.3	3.465	V
		V_{SS}	0.0	0.0	0.0	V
3.3V I/O supply voltage		V_{DDQ}	3.135	3.3	3.465	V
		V_{SSQ}	0.0	0.0	0.0	
2.5V I/O supply voltage		V_{DDQ}	2.35	2.5	2.65	V
		V_{SSQ}	0.0	0.0	0.0	
Input voltages ¹	Address and control pins	V_{IH}	2.0	–	$V_{DD} + 0.3$	V
		V_{IL}	-0.5^2	–	0.8	V
	I/O pins	V_{IH}	2.0	–	$V_{DDQ} + 0.3$	V
		V_{IL}	-0.5^2	–	0.8	
Ambient operating temperature		T_A	0	–	70	°C

¹ Input voltage ranges apply to 3.3V I/O operation. For 2.5V operation, contact factory for input specifications.

² V_{IL} min. = $-2.0V$ for pulse width less than $0.2 \times t_{RC}$.

DC electrical characteristics for 3.3V I/O operation

Parameter	Sym	Test conditions	166		133		100		Unit
			Min	Max	Min	Max	Min	Max	
Input leakage current ¹	$ I_{LI} $	$V_{DD} = \text{Max}, V_{in} = V_{SS} \text{ to } V_{DD}$	–	2	–	2	–	2	μA
Output leakage current	$ I_{LO} $	$\overline{OE} \geq V_{IH}, V_{DD} = \text{Max}, V_{out} = V_{SS} \text{ to } V_{DD}$	–	2	–	2	–	2	μA
Operating power supply current	I_{CC}	$\overline{CE} = V_{IL}, CE = V_{IH}, \overline{CE} = V_{IL}, f = f_{max}, I_{out} = 0 \text{ mA}$	–	475	–	425	–	325	mA
Standby power supply current	I_{SB}	Deselected, $f = f_{max}$	–	130	–	100	–	90	mA
	I_{SB1}	Deselected, $f = 0$, all $V_{IN} \leq 0.2V$ or $\geq V_{DD} - 0.2V$	–	30	–	30	–	30	mA
	I_{SB2}	Deselected, $f = f_{max}, ZZ \geq V_{DD} - 0.2V$ All $V_{IN} \leq V_{IL}$ or $\geq V_{IH}$	–	30	–	30	–	30	mA
Output voltage	V_{OL}	$I_{OL} = 8 \text{ mA}, V_{DDQ} = 3.6V$	–	0.4	–	0.4	–	0.4	V
	V_{OH}	$I_{OH} = -4 \text{ mA}, V_{DDQ} = 3.0V$	2.4	–	2.4	–	2.4	–	V

¹ LBO pin has an internal pull-up, and input leakage = $\pm 10 \mu\text{A}$.

Note: ICC given with no output loading. ICC increases with faster cycle times and greater output loading.



DC electrical characteristics for 2.5V I/O operation

Parameter	Sym	Test conditions	166		133		100		Unit
			Min	Max	Min	Max	Min	Max	
Output leakage current	$ I_{LO} $	$\overline{OE} \geq V_{IH}$, $V_{DD} = \text{Max}$, $V_{out} = V_{SS}$ to V_{DD}	-1	1	-1	1	-1	1	μA
Output voltage	V_{OL}	$I_{OL} = 2 \text{ mA}$, $V_{DDQ} = 2.65\text{V}$	-	0.7	-	0.7	-	0.7	V
	V_{OH}	$I_{OH} = -2 \text{ mA}$, $V_{DDQ} = 2.35\text{V}$	1.7	-	1.7	-	1.7	-	

Timing characteristics over operating range

Parameter	Sym	166		133		100		Unit	Notes
		Min	Max	Min	Max	Min	Max		
Clock frequency	F_{MAX}	-	166	-	133	-	100	MHz	
Cycle time (pipelined mode)	t_{CYC}	6	-	7.5	-	10	-	ns	
Cycle time (flow-through mode)	t_{CYCF}	10	-	12	-	12	-	ns	
Clock access time (pipelined mode)	t_{CD}	-	3.5	-	4.0	-	5.0	ns	
Clock access time (flow-through mode)	t_{CDF}	-	9	-	10	-	12	ns	
Output enable low to data valid	t_{OE}	-	3.5	-	4.0	-	5.0	ns	
Clock high to output low Z	t_{LZC}	0	-	0	-	0	-	ns	2,3,4
Data output invalid from clock high	t_{OH}	1.5	-	1.5	-	1.5	-	ns	4
Output enable low to output low Z	t_{LZOE}	0	-	0	-	0	-	ns	2,3,4
Output enable high to output high Z	t_{HZOE}	-	3.5	-	4.0	-	4.5	ns	2,3,4
Clock high to output high Z	t_{HZC}	-	3.5	-	4.0	-	4.5	ns	2,3,4
Clock high to output high Z	t_{HZCN}	-	1.5	-	2.0	-	2.5	ns	5
Clock high pulse width	t_{CH}	2.4	-	2.5	-	3.0	-	ns	6
Clock low pulse width	t_{CL}	2.2	-	2.5	-	3.0	-	ns	6
Address setup to clock high	t_{AS}	1.5	-	1.5	-	2.0	-	ns	7
Data setup to clock high	t_{DS}	1.5	-	1.5	-	2.0	-	ns	7
Write setup to clock high	t_{WS}	1.5	-	1.5	-	2.0	-	ns	7
Chip select setup to clock high	t_{CSS}	1.5	-	1.5	-	2.0	-	ns	7
Clock enable setup to clock high	t_{CENS}	1.5	-	1.5	-	2.0	-	ns	7
ADV/ \overline{LD} setup to clock high	t_{ADVS}	1.5	-	1.5	-	2.0	-	ns	7
Address hold from clock high	t_{AH}	0.5	-	0.5	-	0.5	-	ns	7
Data hold from clock high	t_{DH}	0.5	-	0.5	-	0.5	-	ns	7
Write hold from clock high	t_{WH}	0.5	-	0.5	-	0.5	-	ns	7
ADV/ \overline{LD} hold from clock high	t_{ADVH}	0.5	-	0.5	-	0.5	-	ns	7
Clock enable hold from clock high	t_{CENH}	0.5	-	0.5	-	0.5	-	ns	7
Output rise time (0 pF load)	t_R	1.5	-	1.5	-	1.5	-	V/ns	
Output fall time (0 pF load)	t_F	1.5	-	1.5	-	1.5	-	V/ns	

See "Notes" on page 9.



Timing waveform of read/write cycle

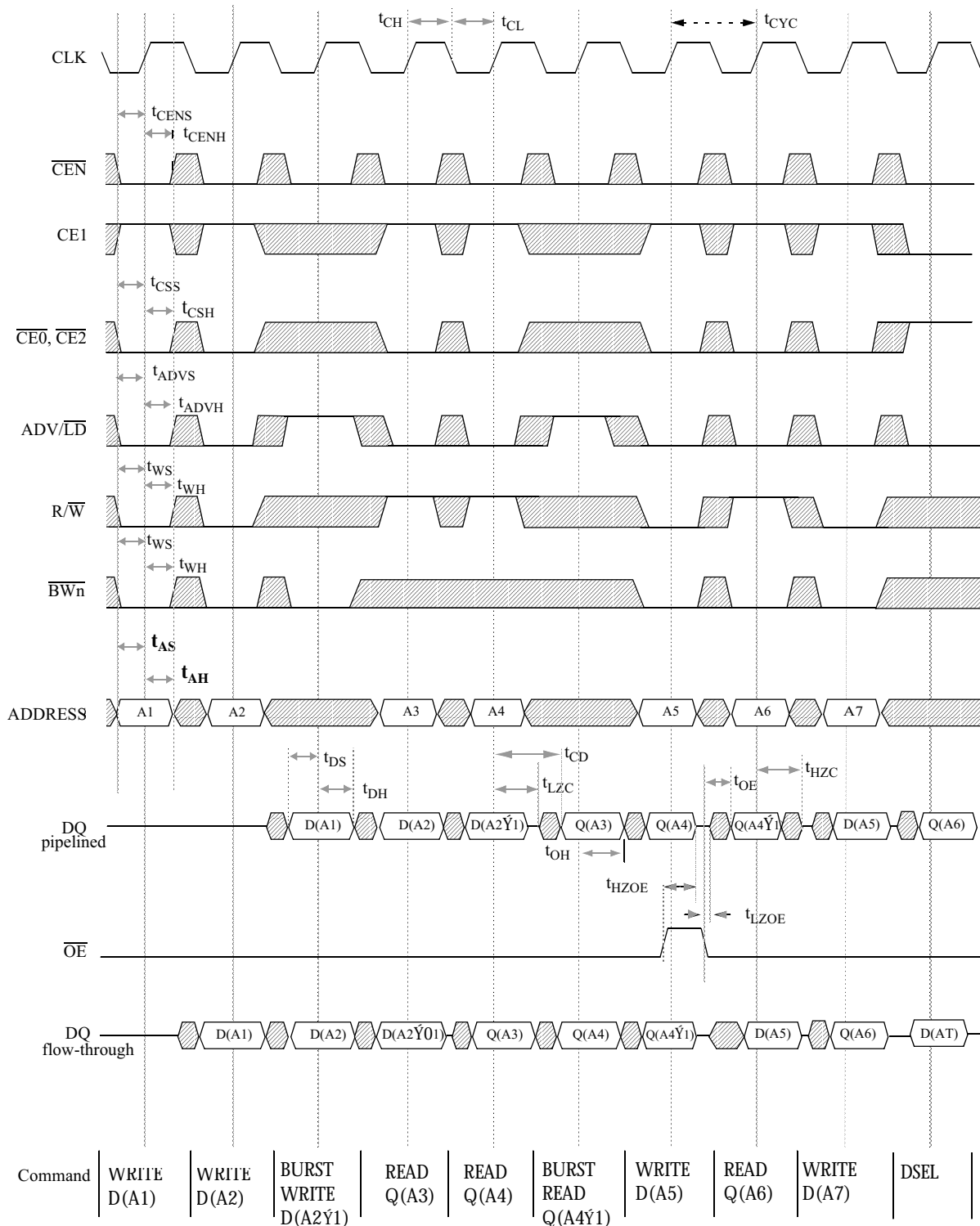

Note: \bar{Y} = XOR when $\overline{LB0}$ = high/no connect. \bar{Y} = ADD when $\overline{LB0}$ = low.
 $\overline{BW[a:b]}$ is don't care.



NOP, stall and deselect cycles

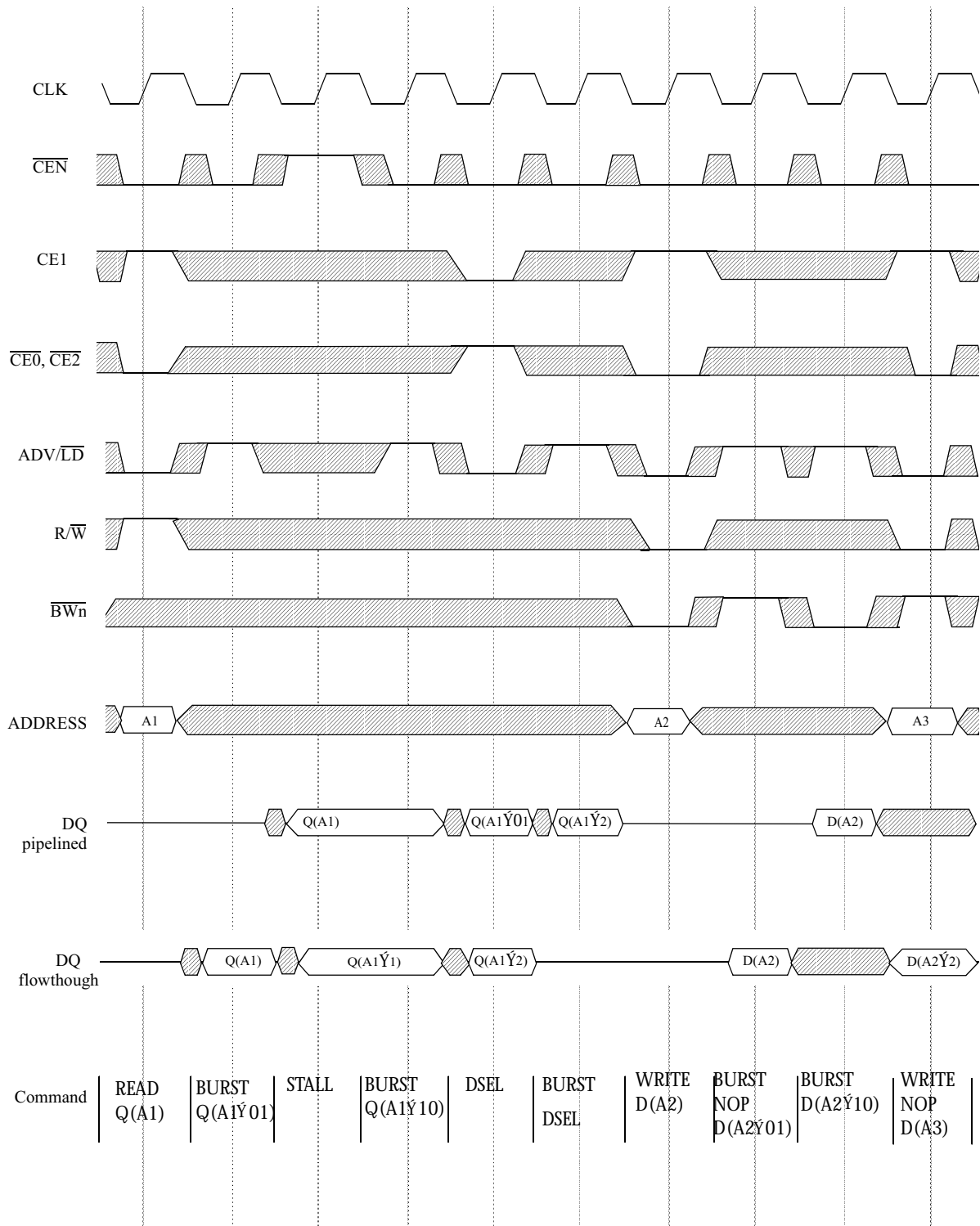

Notes: \overline{OE} is low.
 \dot{Y} = XOR when \overline{LBW} = high/no connect. \dot{Y} = ADD when \overline{LBW} = low



AC test conditions

- Output Load: For t_{LZC} , t_{LZOE} , t_{HZOE} , t_{HZC} , see Figure C. For all others, see Figure B.
- Input pulse level: VSS to 3V. See Figure A.
- Input rise and fall time (measured at 0.3V and 2.7V): 2 ns. See Figure A.
- Input and output timing reference levels: 1.5V.

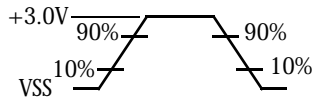

Figure A: Input waveform

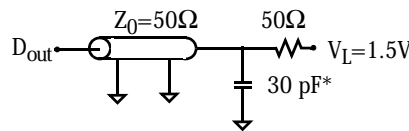

Figure B: Output load (A)

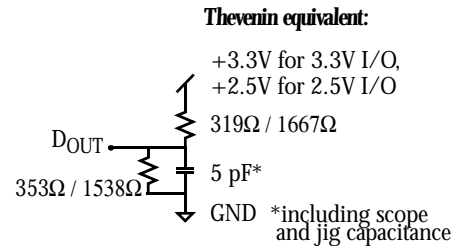

Figure C: Output load (B)

Notes

- 1 For test conditions, see AC Test Conditions, Figures A, B, and C.
- 2 This parameter measured with output load condition in Figure C
- 3 This parameter is sampled and not 100% tested.
- 4 t_{HZOE} is less than t_{LZOE} , and t_{HZC} is less than t_{LZC} at any given temperature and voltage.
- 5 t_{HZCN} is a no-load parameter to indicate exactly when SRAM outputs have stopped driving
- 6 t_{CH} measured as high above V_{IH} , and t_{CL} measured as low below V_{IL}
- 7 This is a synchronous device. All addresses must meet the specified setup and hold times for all rising edges of CLK. All other synchronous inputs must meet the setup and hold times with stable logic levels for all rising edges of CLK when chip is enabled.

Package dimensions

100-pin quad flat pack (TQFP)

	TQFP	
	Min	Max
A1	0.05	0.15
A2	1.35	1.45
b	0.22	0.38
c	0.09	0.20
D	13.90	14.10
E	19.90	20.10
e	0.65 nominal	
Hd	15.90	16.10
He	21.90	22.10
L	0.45	0.75
L1	1.00 nominal	
α	0°	7°
Dimensions in millimeters		

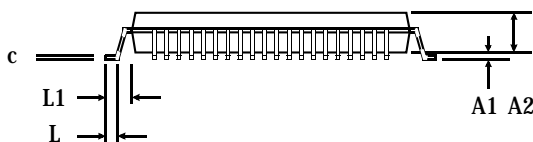
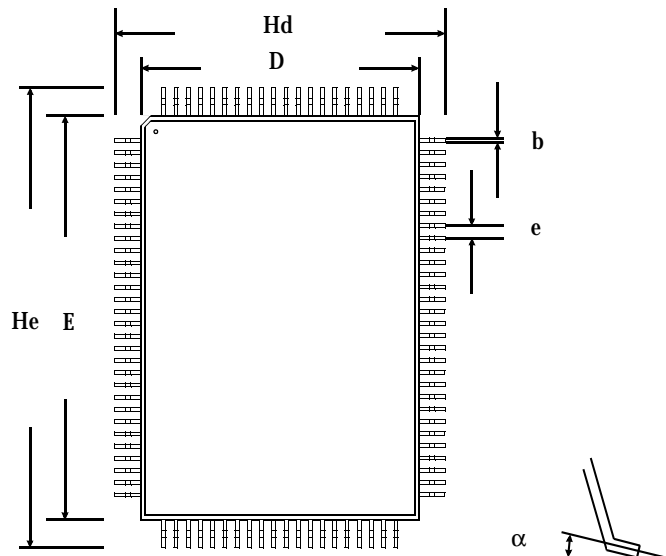



Ordering information

Package	Width	166 MHz	133 MHz	100 MHz
TQFP	×32	AS7C33128NTD32A-166TQC	AS7C33128NTD32A-133TQC	AS7C33128NTD32A-100TQC
TQFP	×36	AS7C33128NTD36A-166TQC	AS7C33128NTD36A-133TQC	AS7C33128NTD36A-100TQC
FBGA	×32	AS7C33128NTD32A-166BC	AS7C33128NTD32A-133BC	AS7C33128NTD32A-100BC
FBGA	×36	AS7C33128NTD36A-166BC	AS7C33128NTD36A-133BC	AS7C33128NTD36A-100BC

Part numbering guide

AS7C	33	128	NTD	32/36	A	-XXX	TQ	C/I
1	2	3	4	5	6	7	8	9

- Alliance Semiconductor SRAM prefix
- Operating voltage: 33 = 3.3V
- Organization: 128 = 128K
- NTD = No Turnaround Delay
- Organization: 32 = x32, 36 = x36
- Production version: A = first production version
- Clock speed (MHz)
- Package type: TQ = TQFP
- Operating temperature: C = commercial (0° C to 70° C), I = industrial (-40° C to 85° C)