

NTMFS4H013NF

Power MOSFET

25 V, 269 A, Single N-Channel, SO-8FL

Features

- Integrated Schottky Diode
- Optimized Design to Minimize Conduction and Switching Losses
- Optimized Package to Minimize Parasitic Inductances
- Optimized material for improved thermal performance
- These Devices are Pb-Free, Halogen Free/BFR Free and are RoHS Compliant

Applications

- High Performance DC-DC Converters
- System Voltage Rails
- Netcom, Telecom
- Servers & Point of Load

MAXIMUM RATINGS (T_J = 25°C unless otherwise stated)

Parameter	Symbol	Value	Units
Drain-to-Source Voltage	V _{DSS}	25	V
Gate-to-Source Voltage	V _{GS}	±20	V
Continuous Drain Current R _{θJA} (T _A = 25°C, Note 1)	I _D	43	A
Power Dissipation R _{θJA} (T _A = 25°C, Note 1)	P _D	2.70	W
Continuous Drain Current R _{θJC} (T _C = 25°C, Note 1)	I _D	269	A
Power Dissipation R _{θJC} (T _C = 25°C, Note 1)	P _D	104	W
Pulsed Drain Current (t _p = 10 μs)	I _{DM}	505	A
Single Pulse Drain-to-Source Avalanche Energy (Note 1) (I _L = 51 A _{pk} , L = 0.3 mH)	E _{AS}	390	mJ
Drain to Source dV/dt	dV/dt	7	V/ns
Maximum Junction Temperature	T _{J(max)}	150	°C
Storage Temperature Range	T _{STG}	-55 to 150	°C
Lead Temperature Soldering Reflow (SMD Styles Only), Pb-Free Versions (Note 2)	T _{SLD}	260	°C

Stresses exceeding those listed in the Maximum Ratings table may damage the device. If any of these limits are exceeded, device functionality should not be assumed, damage may occur and reliability may be affected.

1. Values based on copper area of 645 mm² (or 1 in²) of 2 oz copper thickness and FR4 PCB substrate.
2. For more information, please refer to our Soldering and Mounting Techniques Reference Manual, SOLDERRM/D.
3. This is the absolute maximum rating. Parts are 100% UIS tested at T_J = 25°C, V_{GS} = 10 V, I_L = 33 A, E_{AS} = 164 mJ.

THERMAL CHARACTERISTICS

Parameter	Symbol	Max	Units
Thermal Resistance, Junction-to-Ambient (Note 1 and 4)	R _{θJA}	40.0	°C/W
Junction-to-Case (Note 1 and 4)	R _{θJC}	1.5	

4. Thermal Resistance R_{θJA} and R_{θJC} as defined in JESD51-3.



ON Semiconductor®

www.onsemi.com

V _{GS}	MAX R _{DS(on)}	TYP Q _{GTOT}
4.5 V	1.4 mΩ	26 nC
10 V	0.9 mΩ	56 nC

PIN CONNECTIONS

SO8-FL (5 x 6 mm)

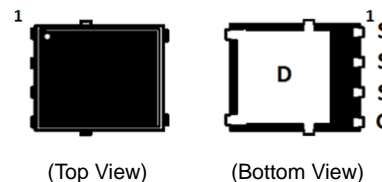

N-CHANNEL MOSFET

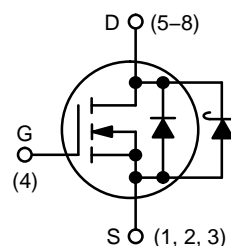

ORDERING INFORMATION

See detailed ordering and shipping information on page 5 of this data sheet.

NTMFS4H013NF

ELECTRICAL CHARACTERISTICS ($T_J = 25^\circ\text{C}$ unless otherwise specified)

Parameter	Symbol	Test Condition	Min	Typ	Max	Unit
OFF CHARACTERISTICS						
Drain-to-Source Breakdown Voltage	$V_{(BR)DSS}$	$V_{GS} = 0\text{ V}, I_D = 250\ \mu\text{A}$	25			V
Drain-to-Source Breakdown Voltage Temperature Coefficient	$V_{(BR)DSS}/T_J$			34.5		mV/°C
Zero Gate Voltage Drain Current	I_{DSS}	$V_{GS} = 0\text{ V}, V_{DS} = 20\text{ V}$			500	μA
Gate-to-Source Leakage Current	I_{GSS}	$V_{DS} = 0\text{ V}, V_{GS} = +20\text{ V}$			+100	nA

ON CHARACTERISTICS (Note 5)

Gate Threshold Voltage	$V_{GS(TH)}$	$V_{GS} = V_{DS}, I_D = 250\ \mu\text{A}$	1.2		2.1	V
Negative Threshold Temperature Coefficient	$V_{GS(TH)}/T_J$			4.6		mV/°C
Drain-to-Source On Resistance	$R_{DS(on)}$	$V_{GS} = 10\text{ V}, I_D = 30\text{ A}$		0.72	0.9	m Ω
		$V_{GS} = 4.5\text{ V}, I_D = 30\text{ A}$		1.1	1.4	
Forward Transconductance	g_{FS}	$V_{DS} = 12\text{ V}, I_D = 15\text{ A}$		119		S

CHARGES, CAPACITANCES & GATE RESISTANCE

Input Capacitance	C_{ISS}	$V_{GS} = 0\text{ V}, f = 1\text{ MHz}, V_{DS} = 12\text{ V}$		3923		pF
Output Capacitance	C_{OSS}			2537		
Reverse Transfer Capacitance	C_{RSS}			114		
Total Gate Charge	$Q_{G(TOT)}$	$V_{GS} = 4.5\text{ V}, V_{DS} = 12\text{ V}; I_D = 30\text{ A}$		26		nC
Threshold Gate Charge	$Q_{G(TH)}$			2.9		
Gate-to-Source Charge	Q_{GS}			10.7		
Gate-to-Drain Charge	Q_{GD}			5.8		
Total Gate Charge	$Q_{G(TOT)}$	$V_{GS} = 10\text{ V}, V_{DS} = 12\text{ V}; I_D = 30\text{ A}$		56		nC
Gate Resistance	R_G	$T_A = 25^\circ\text{C}$		1.0		Ω

SWITCHING CHARACTERISTICS, $V_{GS} = 4.5\text{ V}$ (Note 5)

Turn-On Delay Time	$t_{d(ON)}$	$V_{GS} = 4.5\text{ V}, V_{DD} = 12\text{ V}, I_D = 15\text{ A}, R_G = 3.0\ \Omega$		17.6		ns
Rise Time	t_r			55.1		
Turn-Off Delay Time	$t_{d(OFF)}$			29.4		
Fall Time	t_f			9.96		

SWITCHING CHARACTERISTICS, $V_{GS} = 10\text{ V}$ (Note 5)

Turn-On Delay Time	$t_{d(ON)}$	$V_{GS} = 10\text{ V}, V_{DD} = 12\text{ V}, I_D = 15\text{ A}, R_G = 3.0\ \Omega$		11.3		ns
Rise Time	t_r			44.2		
Turn-Off Delay Time	$t_{d(OFF)}$			39.2		
Fall Time	t_f			7.1		

DRAIN-SOURCE DIODE CHARACTERISTICS

Forward Diode Voltage	V_{SD}	$V_{GS} = 0\text{ V}, I_S = 2.0\text{ A}$	$T_J = 25^\circ\text{C}$		0.38	0.6	V
			$T_J = 125^\circ\text{C}$		0.297		
Reverse Recovery Time	t_{RR}	$V_{GS} = 0\text{ V}, dI_S/dt = 100\text{ A}/\mu\text{s}, I_S = 30\text{ A}$		61.3		ns	
Charge Time	t_a			30.4			
Discharge Time	t_b			30.9			
Reverse Recovery Charge	Q_{RR}			66			nC

Product parametric performance is indicated in the Electrical Characteristics for the listed test conditions, unless otherwise noted. Product performance may not be indicated by the Electrical Characteristics if operated under different conditions.

5. Pulse Test: pulse width $\leq 300\ \mu\text{s}$, duty cycle $\leq 2\%$.

6. Switching characteristics are independent of operating junction temperatures.

NTMFS4H013NF

TYPICAL CHARACTERISTICS

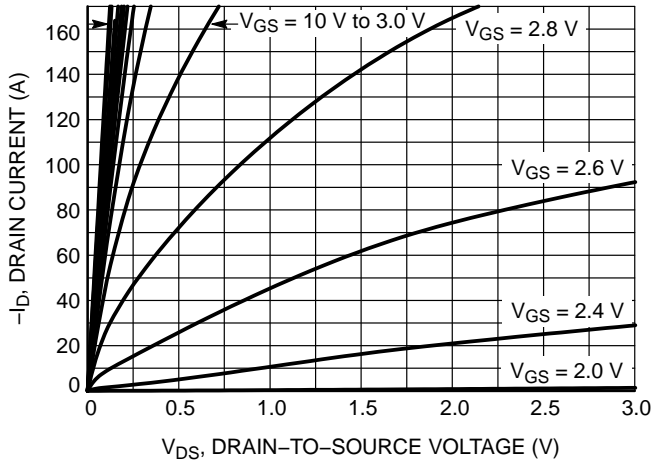

Figure 1. On-Region Characteristics

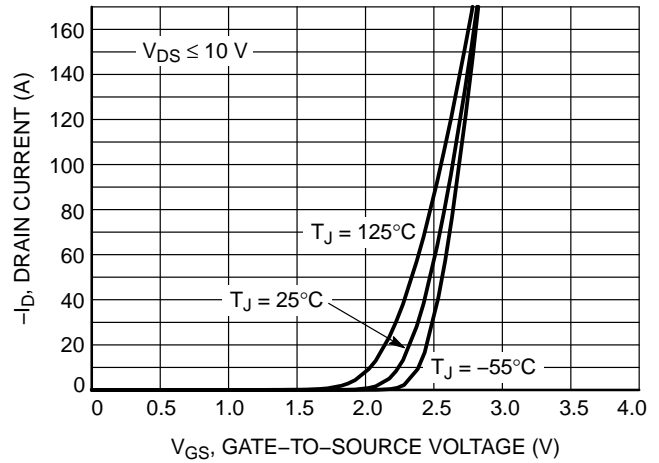

Figure 2. Transfer Characteristics

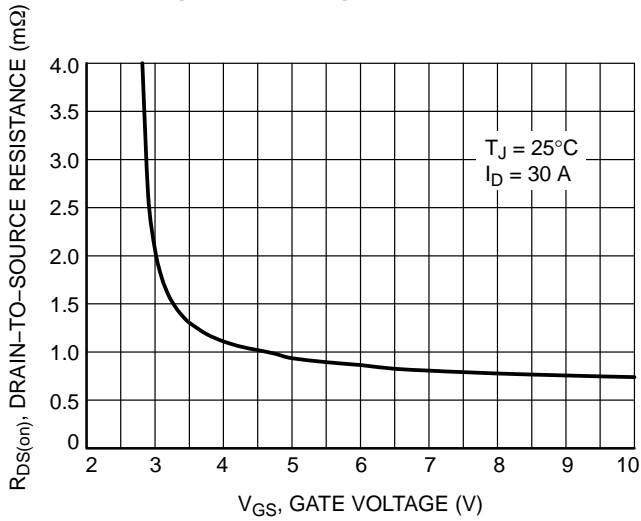

Figure 3. On-Resistance vs. Gate-to-Source Voltage

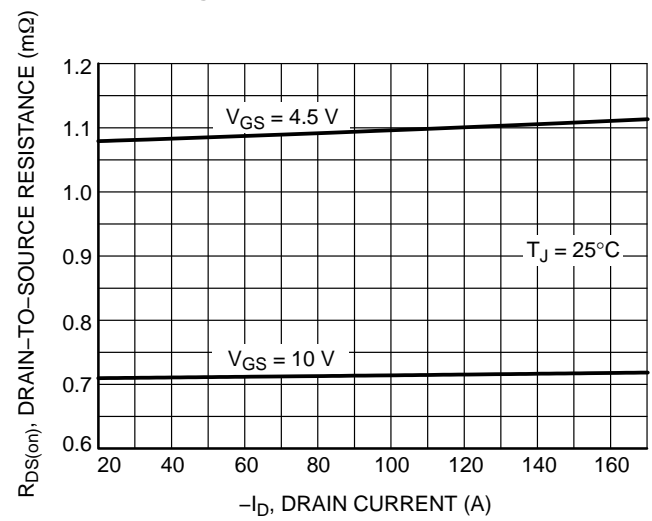

Figure 4. On-Resistance vs. Drain Current and Gate Voltage

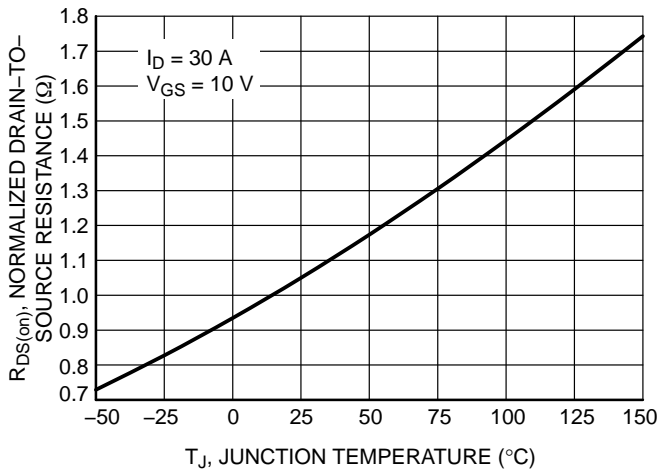

Figure 5. On-Resistance Variation with Temperature

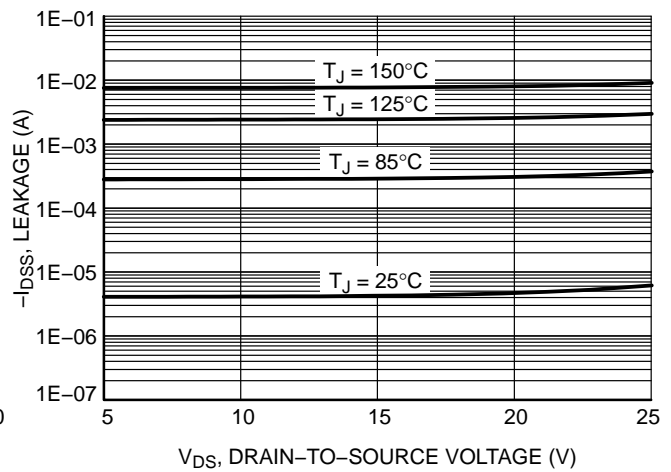

Figure 6. Drain-to-Source Leakage Current vs. Voltage

NTMFS4H013NF

TYPICAL CHARACTERISTICS

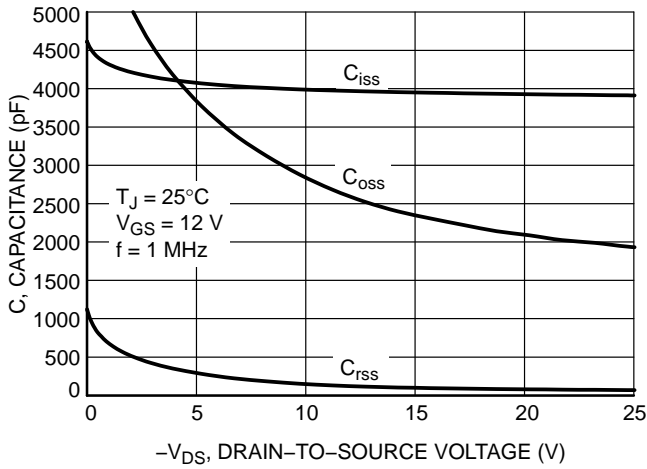

Figure 7. Capacitance Variation

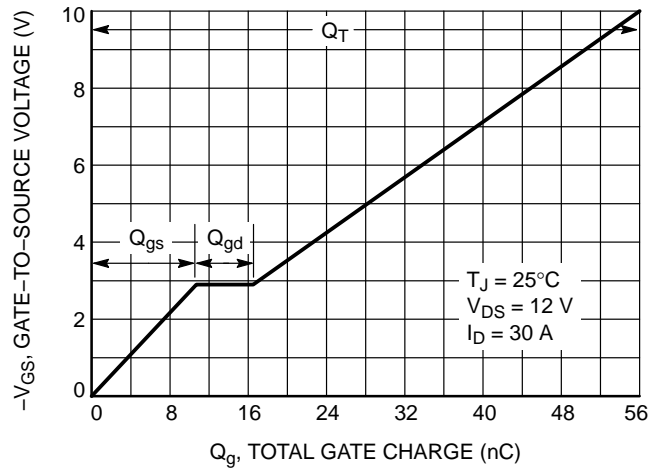

Figure 8. Gate-to-Source and Drain-to-Source Voltage vs. Total Charge

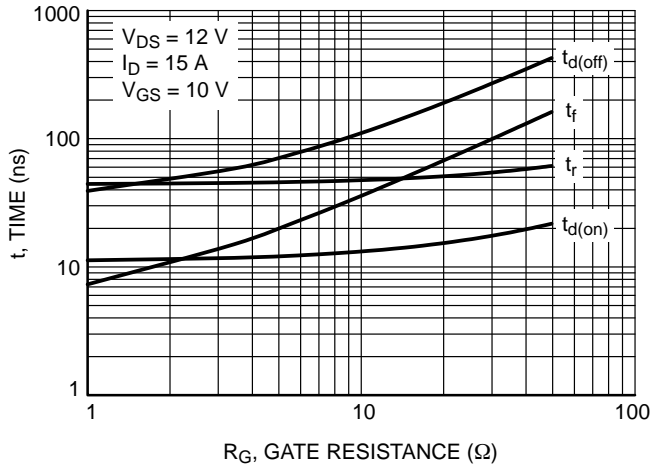

Figure 9. Resistive Switching Time Variation vs. Gate Resistance

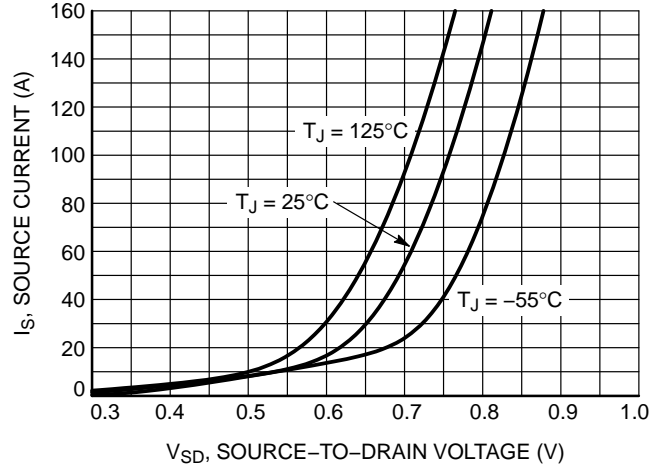

Figure 10. Diode Forward Voltage vs. Current

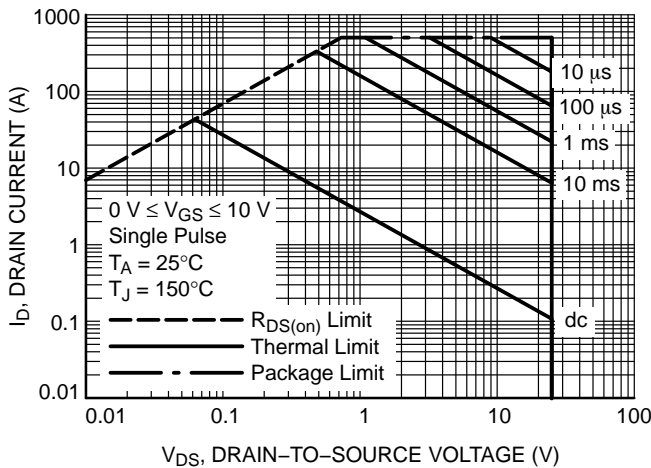

Figure 11. Maximum Rated Forward Biased Safe Operating Area

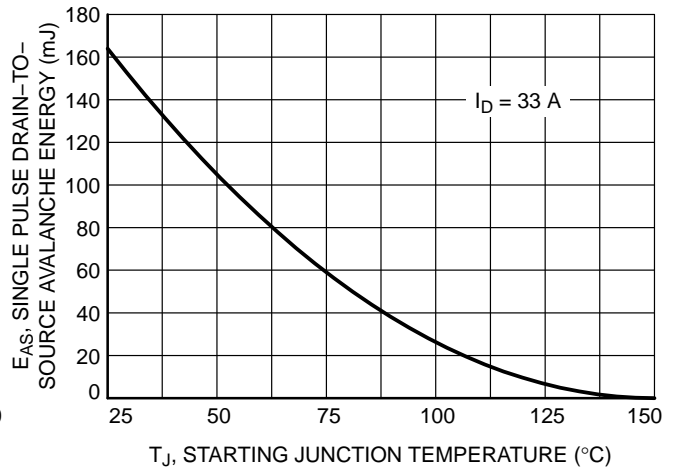

Figure 12. Maximum Avalanche Energy vs. Starting Junction Temperature

NTMFS4H013NF

TYPICAL CHARACTERISTICS

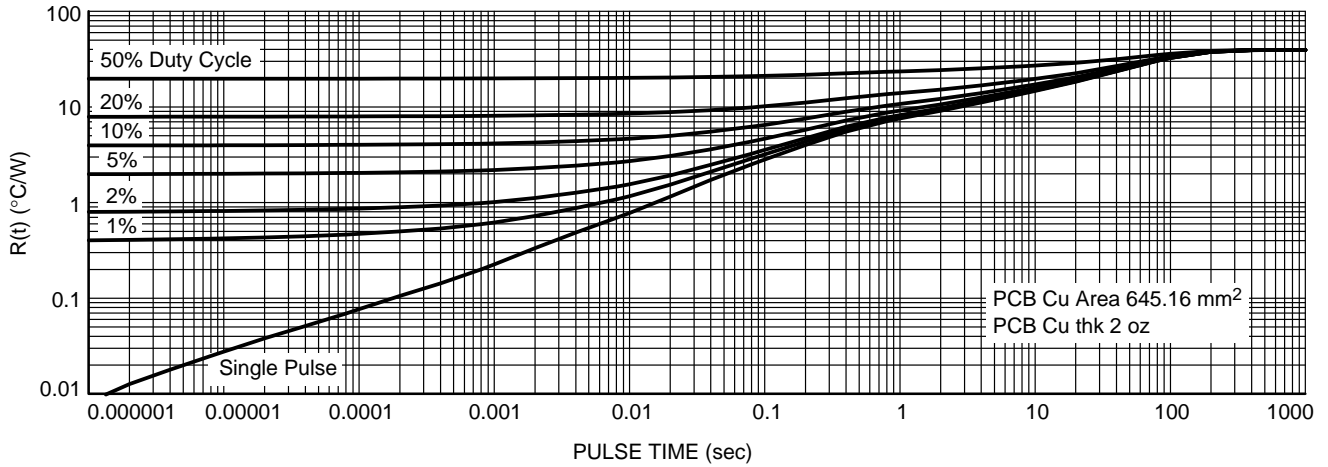

Figure 13. Thermal Characteristics

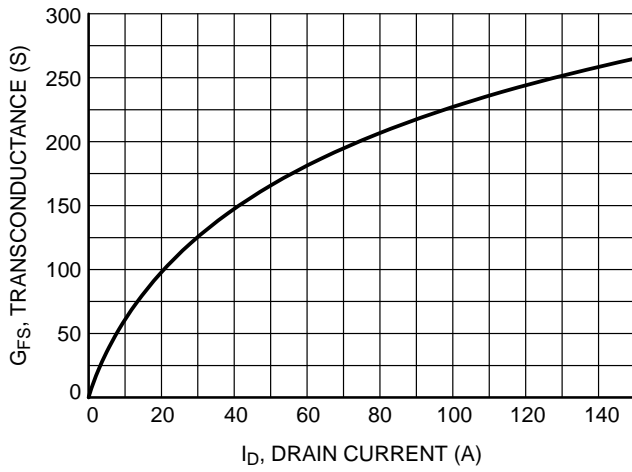

Figure 14. GFS vs. I_D

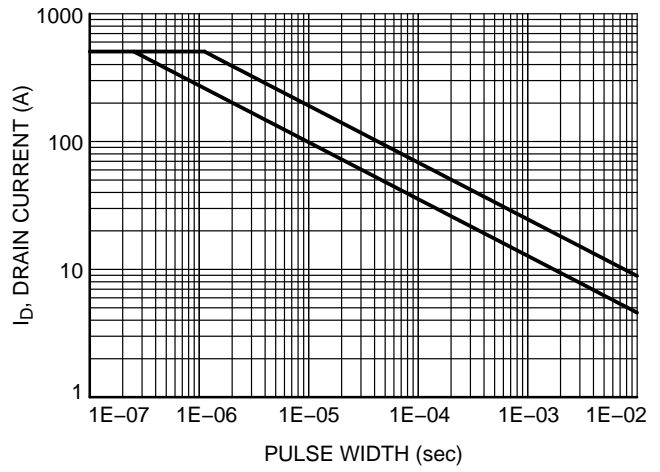

Figure 15. Avalanche Characteristics

ORDERING INFORMATION

Device	Package	Shipping†
NTMFS4H013NFT1G	SO8-FL (Pb-Free)	1500 / Tape & Reel
NTMFS4H013NFT3G	SO8-FL (Pb-Free)	5000 / Tape & Reel

†For information on tape and reel specifications, including part orientation and tape sizes, please refer to our Tape and Reel Packaging Specifications Brochure, BRD8011/D.



MARKING DIAGRAM

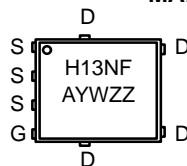

- A = Assembly Location
- Y = Year
- W = Work Week
- ZZ = Lot Traceability

NTMFS4H013NF

PACKAGE DIMENSIONS

DFN5 5x6, 1.27P
(SO-8FL)
CASE 488AA
ISSUE K

NOTES:

1. DIMENSIONING AND TOLERANCING PER ASME Y14.5M, 1994.
2. CONTROLLING DIMENSION: MILLIMETER.
3. DIMENSION D1 AND E1 DO NOT INCLUDE MOLD FLASH PROTRUSIONS OR GATE BURRS.

DIM	MILLIMETERS		
	MIN	NOM	MAX
A	0.90	1.00	1.10
A1	0.00	---	0.05
b	0.33	0.41	0.51
c	0.23	0.28	0.33
D	5.00	5.15	5.30
D1	4.70	4.90	5.10
D2	3.80	4.00	4.20
E	6.00	6.15	6.30
E1	5.70	5.90	6.10
E2	3.45	3.65	3.85
e	1.27 BSC		
G	0.51	0.61	0.71
K	1.20	1.35	1.50
L	0.51	0.61	0.71
L1	0.125 REF		
M	3.00	3.40	3.80
θ	0°	---	12°

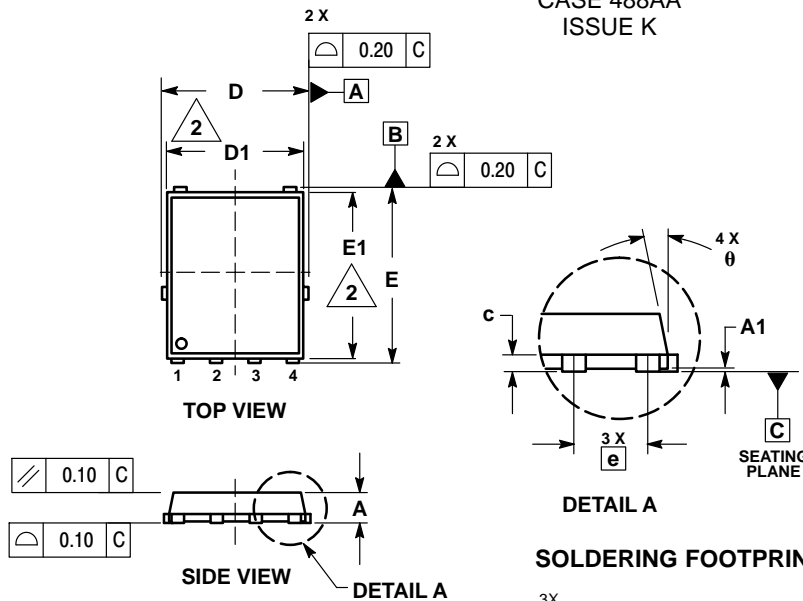

SOLDERING FOOTPRINT*

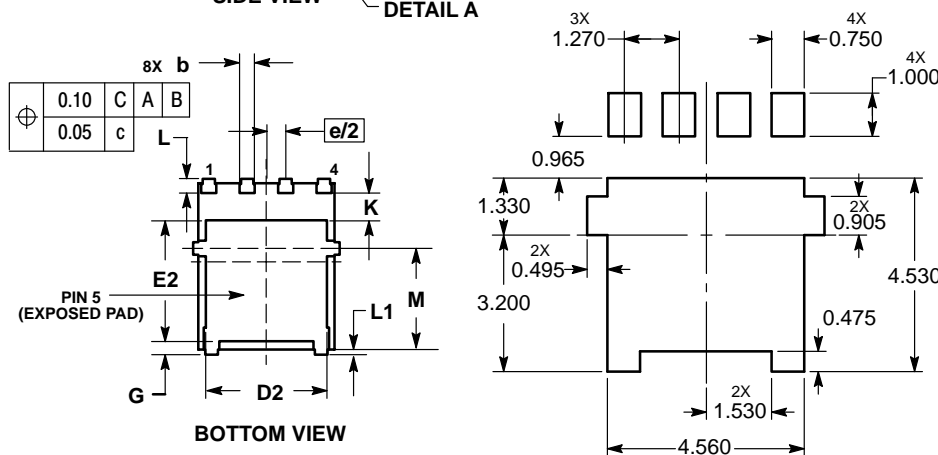

STYLE 1:

1. SOURCE
2. SOURCE
3. SOURCE
4. GATE
5. DRAIN

*For additional information on our Pb-Free strategy and soldering details, please download the ON Semiconductor Soldering and Mounting Techniques Reference Manual, SOLDERRM/D.

ON Semiconductor and the are registered trademarks of Semiconductor Components Industries, LLC (SCILLC) or its subsidiaries in the United States and/or other countries. SCILLC owns the rights to a number of patents, trademarks, copyrights, trade secrets, and other intellectual property. A listing of SCILLC's product/patent coverage may be accessed at www.onsemi.com/site/pdf/Patent-Marking.pdf. SCILLC reserves the right to make changes without further notice to any products herein. SCILLC makes no warranty, representation or guarantee regarding the suitability of its products for any particular purpose, nor does SCILLC assume any liability arising out of the application or use of any product or circuit, and specifically disclaims any and all liability, including without limitation special, consequential or incidental damages. "Typical" parameters which may be provided in SCILLC data sheets and/or specifications can and do vary in different applications and actual performance may vary over time. All operating parameters, including "Typicals" must be validated for each customer application by customer's technical experts. SCILLC does not convey any license under its patent rights nor the rights of others. SCILLC products are not designed, intended, or authorized for use as components in systems intended for surgical implant into the body, or other applications intended to support or sustain life, or for any other application in which the failure of the SCILLC product could create a situation where personal injury or death may occur. Should Buyer purchase or use SCILLC products for any such unintended or unauthorized application, Buyer shall indemnify and hold SCILLC and its officers, employees, subsidiaries, affiliates, and distributors harmless against all claims, costs, damages, and expenses, and reasonable attorney fees arising out of, directly or indirectly, any claim of personal injury or death associated with such unintended or unauthorized use, even if such claim alleges that SCILLC was negligent regarding the design or manufacture of the part. SCILLC is an Equal Opportunity/Affirmative Action Employer. This literature is subject to all applicable copyright laws and is not for resale in any manner.

PUBLICATION ORDERING INFORMATION

LITERATURE FULFILLMENT:

Literature Distribution Center for ON Semiconductor
P.O. Box 5163, Denver, Colorado 80217 USA
Phone: 303-675-2175 or 800-344-3860 Toll Free USA/Canada
Fax: 303-675-2176 or 800-344-3867 Toll Free USA/Canada
Email: orderlit@onsemi.com

N. American Technical Support: 800-282-9855 Toll Free
USA/Canada
Europe, Middle East and Africa Technical Support:
Phone: 421 33 790 2910
Japan Customer Focus Center
Phone: 81-3-5817-1050

ON Semiconductor Website: www.onsemi.com

Order Literature: <http://www.onsemi.com/orderlit>

For additional information, please contact your local Sales Representative