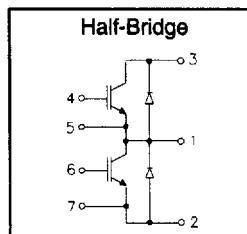


"HALF-BRIDGE" IGBT INT-A-PAK

Fast Speed IGBT

- Rugged Design
- Simple gate-drive
- Fast operation up to 10KHz hard switching, or 50KHz resonant
- Switching-Loss Rating includes all "tail" losses



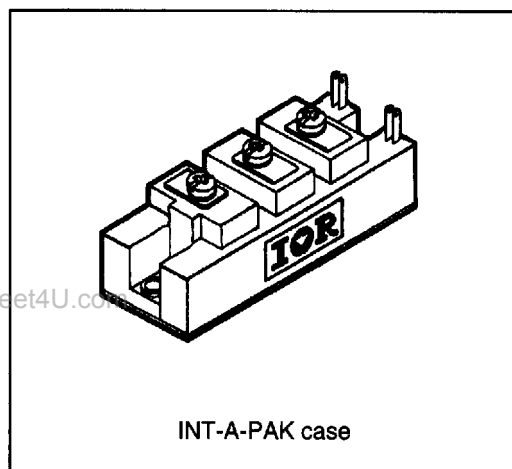
$$V_{CE} = 600V$$

$$I_C = 200A$$

$$V_{CE(ON)} < 2.3V$$

Description

IR's advanced IGBT technology is the key to this line of INT-A-pak Power Modules. The efficient geometry and unique processing of the IGBT allow higher current densities than comparable bipolar power module transistors, while at the same time requiring the simpler gate-drive of the familiar power MOSFET. This superior technology has now been coupled to state of the art assembly techniques to produce a higher current module that is highly suited to power applications such as motor drives, uninterruptible power supplies, welding, induction heating and ultrasonics.



Absolute Maximum Ratings

Parameter	Description	Value	Units
V_{CES}	Continuous collector to emitter voltage	600	V
$I_C @ T_C = 25^\circ C$	Continuous collector current	200	A
$I_C @ T_C = 85^\circ C$	Continuous collector current	130	
$I_C @ T_C = 100^\circ C$	Continuous collector current	110	
I_{LM}	Peak switching current	400	
I_{FM}	Peak diode forward current (1)	500	
V_{GE}	Gate to emitter voltage	± 20	V
V_{ISOL}	RMS isolation voltage, any terminal to case, $t = 1$ min	2500	
$P_D @ T_C = 25^\circ C$	Power dissipation	500	W
T_J	Operating junction temperature range	-40 to 150	$^\circ C$
T_{STG}	Storage temperature range	-40 to 125	

(1) Duration limited by max junction temperature.

Electrical Characteristics - $T_J = 25^\circ\text{C}$, unless otherwise stated

Parameter	Description	Min	Typ	Max	Units	Test Conditions
BV_{CES}	Collector-to-emitter breakdown voltage	600	—	—	v	$V_{GE} = 0V, I_C = 2mA$
$V_{CE(ON)}$	Collector-to-emitter voltage	—	—	2.3		$V_{GE} = 15V, I_C = 200A$
		—	2.2	—		$V_{GE} = 15V, I_C = 200A, T_J = 150^\circ\text{C}$
V_{FM}	Diode forward voltage - maximum	—	—	2.9		$I_F = 200A, V_{GE} = 0V$
		—	2.8	—		$I_F = 200A, V_{GE} = 0V, T_J = 150^\circ\text{C}$
V_{GEth}	Gate threshold voltage	3.0	—	5.5	$I_C = 1mA$	
ΔV_{GEth}	Threshold voltage temp. coefficient	—	-11	—	mV/°C	$V_{CE} = V_{GE}, I_C = 1mA$
g_{fe}	Forward transconductance	104	—	144	S(Ω)	$V_{CE} = 25V, I_C = 200A$
I_{CES}	Collector-to-emitter leakage current	—	—	2	mA	$V_{GE} = 0V, V_{CE} = 600V$
		—	—	20		$V_{GE} = 0V, V_{CE} = 600V, T_J = 150^\circ\text{C}$
I_{GES}	Gate-to-emitter leakage current	—	—	±2	μA	$V_{GE} = \pm 20V$

Dynamic Characteristics - $T_J = 150^\circ\text{C}$

Parameter	Description	Min	Typ	Max	Units	Test Conditions
E_{on}	Turn-on switching energy	—	0.05	—	mJ/A	$R_{G1} = 27\Omega, R_{G2} = 0\Omega$
E_{off} (1)	Turn-off switching energy	—	0.17	—		$I_C = 200A, L_S = 100nH$
E_{ts} (1)	Total switching energy	—	—	0.3		$V_{CC} = 360V, V_{GE} = \pm 15V$
$t_{d(on)}$	Turn-on delay time	—	80	—	ns	$R_{G1} = 27\Omega, R_{G2} = 0\Omega$
t_r	Rise time	—	150	—		$I_C = 200A$
$t_{d(off)}$	Turn-off delay time	—	450	—		$V_{CC} = 360V, V_{GE} = \pm 15V$
t_f	Fall time	—	900	—		$L_S = 100nH$
I_{rr}	Diode peak recovery current	—	108	—	A	$R_{G1} = 27\Omega, R_{G2} = 0\Omega$
t_{rr}	Diode recovery time	—	115	—	ns	$I_C = 200A$
Q_{rr}	Diode recovery charge	—	6.5	—	μC	$V_{CC} = 360V, V_{GE} = \pm 15V$
Q_{ge}	Gate-to-emitter charge (turn-on)	300	—	560	nC	$V_{CC} = 360V$
Q_{gc}	Gate-to-collector charge (turn-on)	140	—	280		$I_C = 108A$
Q_g	Total gate charge (turn-on)	52	—	84		$V_{GE} = 15V$
C_{ies}	Input capacitance	—	11600	—	pF	$V_{GE} = 0V$
C_{oes}	Output capacitance	—	1320	—		$V_{CC} = 30V$
C_{res}	Reverse transfer capacitance	—	160	—		$f = 1MHz$

(1) Includes tail losses

Thermal and Mechanical Characteristics

Parameter	Description	Typ	Max	Units
R_{thJC} (IGBT)	Thermal resistance, junction to case, each IGBT	—	0.25	°C/W
R_{thJC} (Diode)	Thermal resistance, junction to case, each diode	—	0.4	
R_{thCS} (Module)	Thermal resistance, case to sink	0.1	—	
Wt	Weight of module	140	—	g

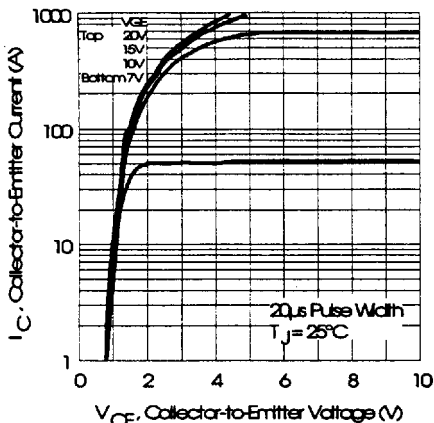


Fig. 1 - Typical Output Characteristics, $T_j = 25^\circ\text{C}$

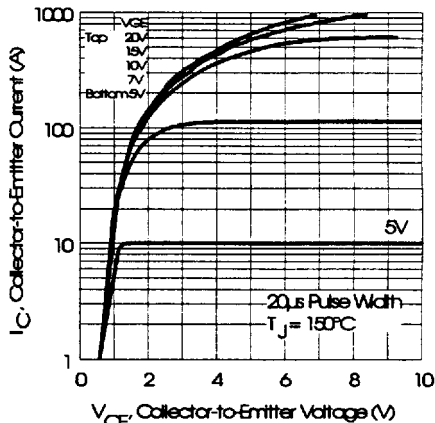


Fig. 2 - Typical Output Characteristics, $T_j = 150^\circ\text{C}$

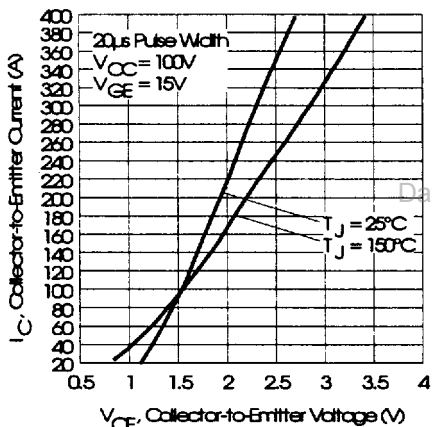


Fig. 3 - Typical Output Characteristics

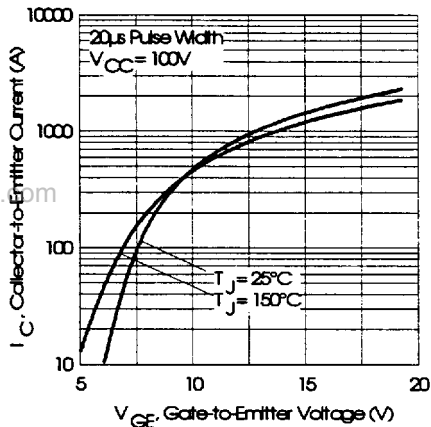


Fig. 4 - Typical Transfer Characteristics

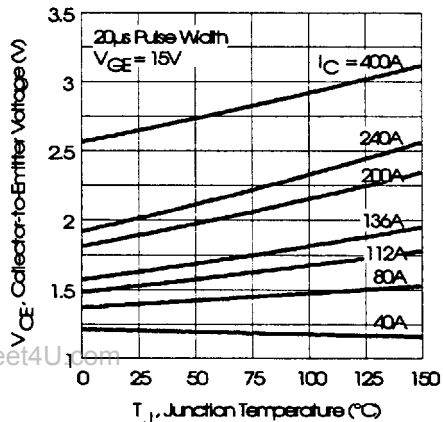


Fig. 5 - Collector-to-Emitter Saturation Typical Voltage vs. Junction Temperature

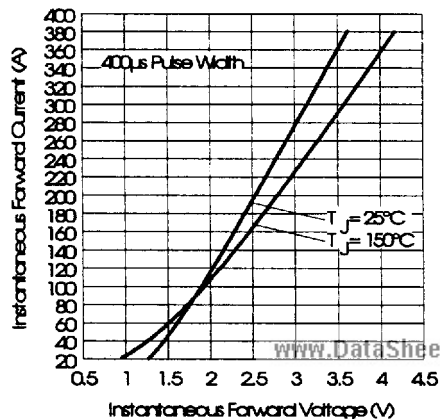


Fig. 6 - Forward Voltage Drop Characteristics

IRGT1200F06

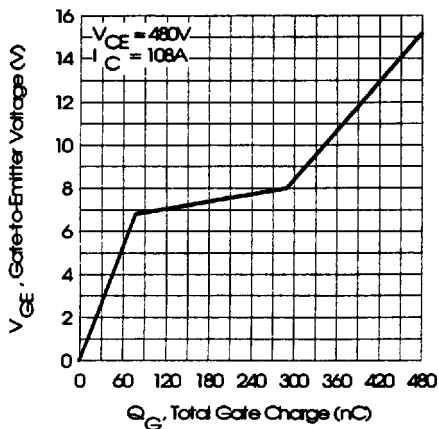


Fig. 7 - Typical Gate Charge vs. Gate-to-Emitter Voltage

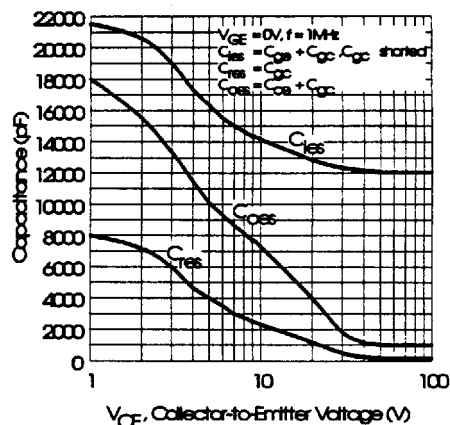


Fig. 8 - Typical Capacitance vs. Collector-to-Emitter Voltage

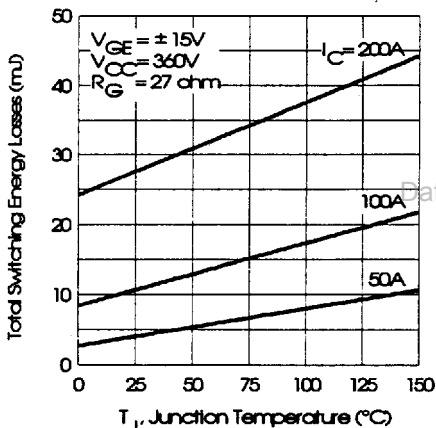


Fig. 9 - Typical Switching Losses vs. Junction Temperature

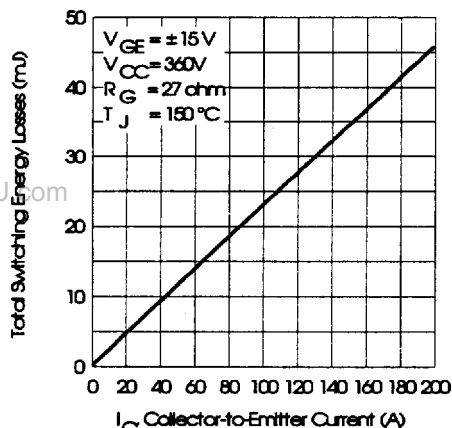


Fig. 10 - Typical Switching Losses vs. Collector-to-Emitter Current

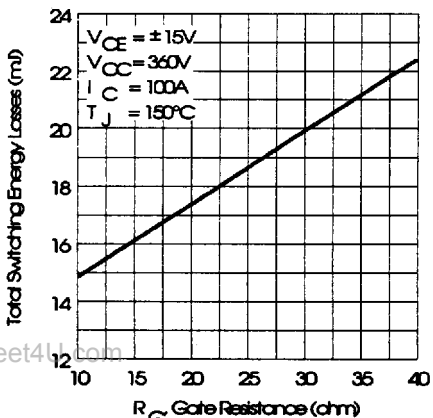


Fig. 11 - Typical Switching Losses vs. Gate Resistance

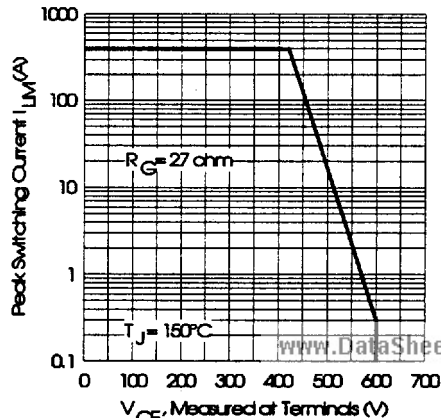


Fig. 12 - Reverse Bias Safe Operating Area

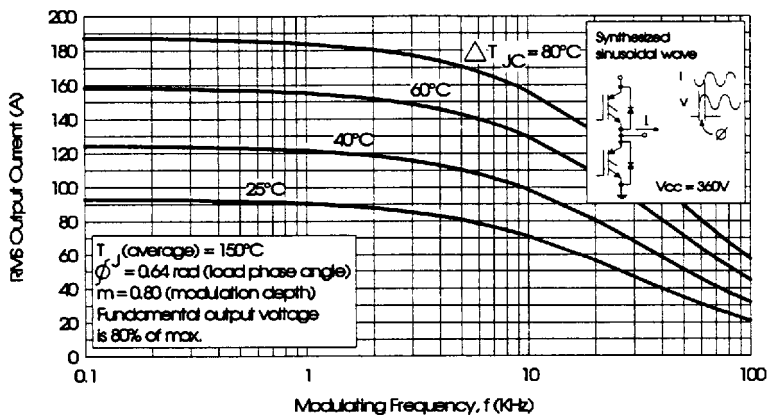


Fig. 13 - Typical RMS Output Current per phase vs. Frequency (Synthesized Sinusoidal Wave)

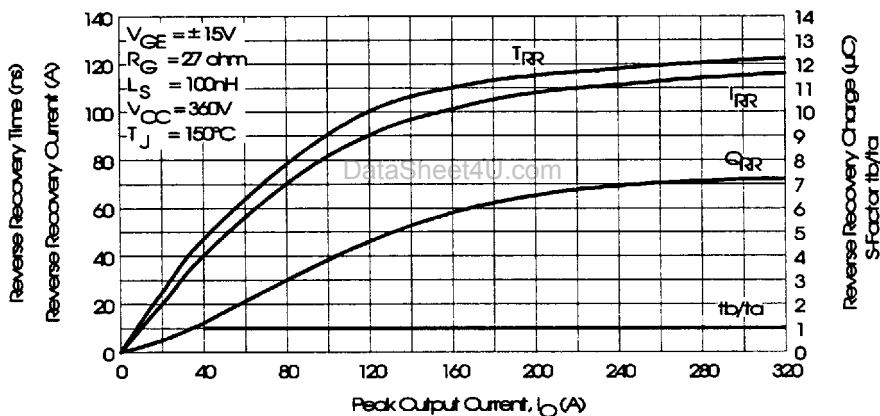
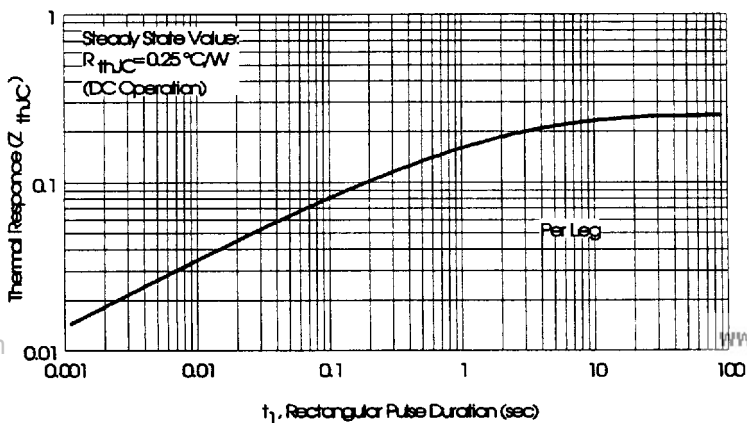
Fig. 14 - Typical Diode Recovery Characteristics as Function of Output Current I_o 

Fig. 15 - Maximum Effective Transient Thermal Impedance, Junction-to-Case

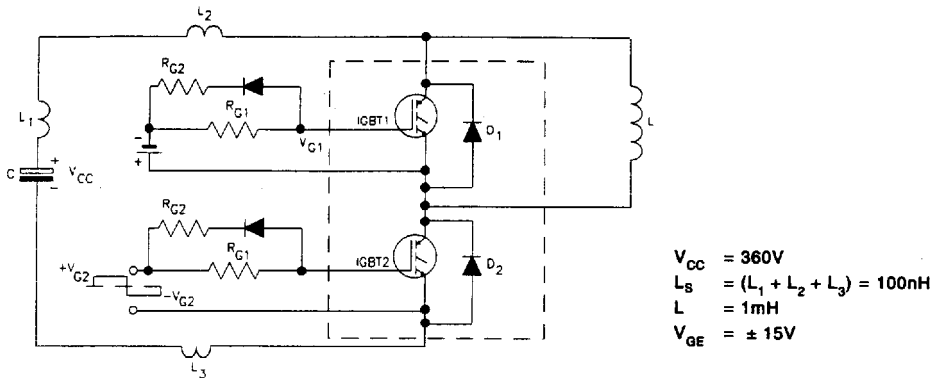


Fig. 16 - Test Circuit for Measurement of I_{LM} , E_{ON} , E_{OFF} , Q_{RR} , I_{RR} , $t_{D(ON)}$, t_r , $t_{D(OFF)}$, t_f

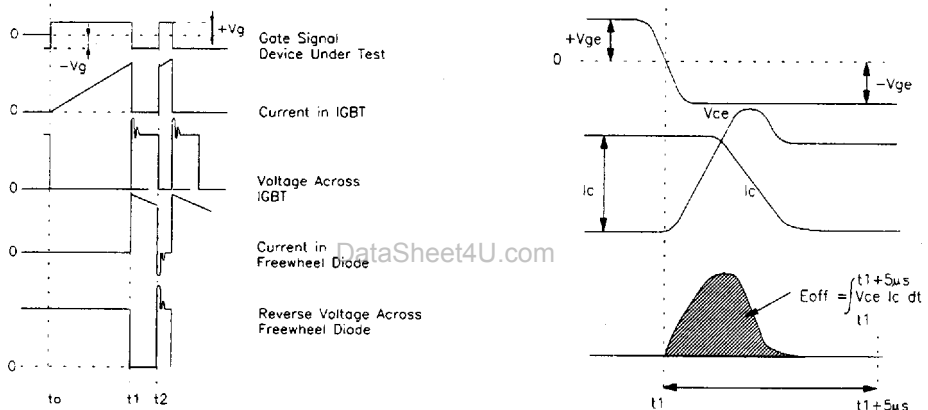


Fig. 17 - Test Waveforms for Circuit of Fig. 16

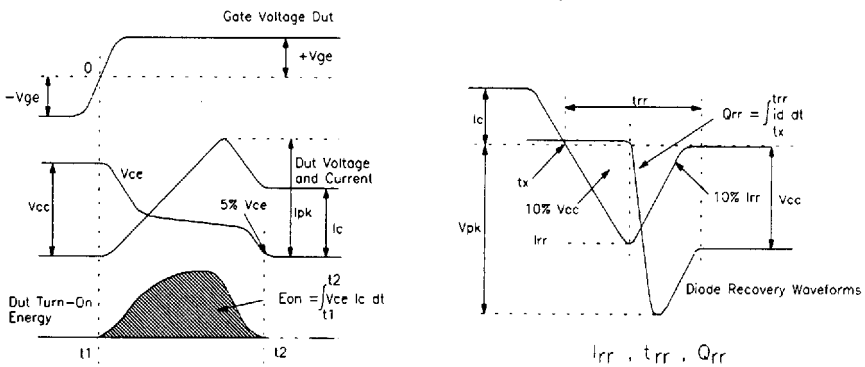


Fig. 18 - Test Waveforms for Circuit of Fig. 16, Defining E_{ON} , E_{REC} , $t_{D(ON)}$, t_r , I_{RR} , t_{RR} , Q_{RR}

Refer to Section D for the following:

Appendix E: Section D - page D-7 Fig. 19 - Waveforms for Switching Time
 Package Outline 10 - INT-A-PAK Half Bridge Section D - Page D-16