

TAD100 SERIES

2 X 3 Inch AC-DC POWER SUPPLIES

UNIVERSAL INPUT RANGE
 UP TO 100Watts

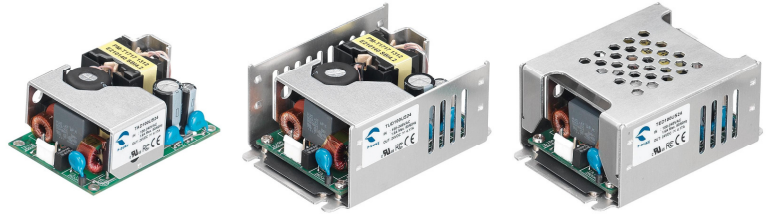

FEATURES

- LOW STANDBY POWER CONSUMPTION UNDER 0.3 WATT
- WIDE INPUT VOLTAGE RANGE 85 TO 264VAC, 47 TO 63HZ
- ACTIVE POWER FACTOR CORRECTION
- BUILT-IN EMI FILTER
- OUTPUT VOLTAGE ADJUSTABLE
- OPEN FRAME DIMENSIONS 2.00 X 3.00 X 1.16 INCH
- 3000VAC INPUT TO OUTPUT REINFORCED INSULATION
- PROTECTION TYPE CLASS I AND CLASS II
- LOW LEAKAGE CURRENT UNDER 300µA
- OPERATING ALTITUDE 5000M
- 3 YEAR WARRANTY
- UL60950-1, EN60950-1, & IEC60950-1 SAFETY APPROVALS
- CE MARKED
- COMPLIANT TO RoHS II & REACH

APPLICATIONS

- WIRELESS NETWORK
- TELECOM/DATACOM
- INDUSTRY CONTROL SYSTEM
- MEASUREMENT EQUIPMENT
- SEMICONDUCTOR EQUIPMENT

3000VAC ISOLATION	OCP	SCP	OVP	LOW STANDBY POWER
-------------------	-----	-----	-----	-------------------

TECHNICAL SPECIFICATION

All specifications are typical at 230VAC input, full load and 25°C otherwise noted

Model Number	Input Range	Output Voltage	Output Current @ Natural convection 50°C Ta	Input Power @ No Load	Efficiency
	VAC	VDC	A	W	%
TAD100US12	85 ~ 264	12	8.34	0.3	91
TAD100US15	85 ~ 264	15	6.67	0.3	92
TAD100US24	85 ~ 264	24	4.17	0.3	92
TAD100US28	85 ~ 264	28	3.58	0.3	92
TAD100US36	85 ~ 264	36	2.78	0.3	91
TAD100US48	85 ~ 264	48	2.09	0.3	91

PART NUMBER STRUCTURE

T	A	D	100	U	S	12	□
Application	Package Code	Dimension Code	Output Power (W)	Input Voltage (VAC)	Output Quantity	Output Voltage (VDC)	Protection Type
Industry Application	A: Open type U: U chassis type E: Enclosed type D: Din rail (E type only)			U: Universal 85 ~ 264VAC	S: Single	12: 12V 15: 15V 24: 24V 28: 28V 36: 36V 48: 48V	No suffix: CLASS I B: CLASS II

INPUT SPECIFICATIONS

Parameter	Conditions	Min.	Typ.	Max.	Unit
Operating input voltage range	AC input	85		264	VAC
	DC input	120		370	VDC
Input frequency	AC input	47		63	Hz
Input current	115VAC and Full Load			1.15	A
	230VAC and Full Load			0.55	A
No load input power	230VAC			0.3	Watts
Leakage current	264VAC			300	μA
Power Factor		0.95			
Start up time				1000	ms
Rise time			20		ms
Hold up time	115VAC and Full Load	22			ms
Input inrush current	230VAC			100	A
Input protection	Internal fuse			T3.15A/250VAC	

OUTPUT SPECIFICATIONS

Parameter	Conditions	Min.	Typ.	Max.	Unit
Output power	Open frame			100	Watts
Initial set voltage accuracy	230VAC and Full Load	-1.0		+1.0	%
Line regulation	Low Line to High Line at Full Load	-0.2		+0.2	%
Load regulation	No Load to Full Load	-0.5		+0.5	%
	10% Load to 90% Load	-0.4		+0.4	%
Voltage adjustability		-10		+10	%
Minimum load			0		%
Ripple and noise	Measured by 20MHz bandwidth				
	With a 10μF/25V 1206 X7R MLCC	12Vout	120		mVp-p
	With a 10μF/25V 1206 X7R MLCC	15Vout	150		
	With a 1μF/50V 1206 X7R MLCC	24Vout	160		
	With a 1μF/50V 1206 X7R MLCC	28Vout	180		
	With a 1μF/50V 1206 X7R MLCC	36Vout	190		
With a 0.1μF/100V 1206 X7R MLCC	48Vout	340			
Temperature coefficient		-0.02		+0.02	%/°C
Transient response	Load step form 50 ~ 75% change at 2.5A/μs	Peak deviation		3	% Vout
		Recovery time	500		μs
Over voltage protection	% of Vout(nom); Latch mode	115		135	%
Over load protection	% of Iout rated; Hiccup mode	115		150	%
Short circuit protection					Continuous, automatic recovery

GENERAL SPECIFICATIONS

Parameter	Conditions	Min.	Typ.	Max.	Unit
Isolation voltage	1 minute (Reinforced insulation)	3000			VAC
		1500			
Isolation resistance	500VDC	0.1			GΩ
Switching frequency			60		kHz
Safety approvals					UL60950-1 EN60950-1 IEC60950-1
Weight	TAD			156g (5.50oz)	
	TUD			194g (6.84oz)	
	TED			210g (7.41oz)	
	TDD			232g (8.18oz)	
MTBF	MIL-HDBK-217F Ta=25°C, Full load				7.903 x 10 ⁵ hrs

ENVIRONMENTAL SPECIFICATIONS

Parameter	Conditions	Min.	Typ.	Max.	Unit
Operating ambient temperature	Natural convection and Full load (with derating)				°C
	-40°C start up : 80% Load,max. @ Vin > 100VAC -40°C start up : 100% Load,max. @ Vin > 200VAC	-40		+80	
Storage temperature range		-40		+85	°C
Operating altitude				5000	m
Thermal shock					MIL-STD-810F
Shock					IEC68-2-27
Vibration					IEC68-2-6
Relative humidity	Non-condensing				5% to 95% RH

EMC SPECIFICATIONS

Parameter	Conditions	Level
EMI	EN55011, EN55022 and FCC Part 15	Conducted Class B Radiated Class A
Harmonic currents	EN61000-3-2 Full Load	Class A and D
Voltage flicker	EN61000-3-3	
ESD	EN61000-4-2 Air ± 8kV and Contact ± 6kV	Perf. Criteria A
Radiated immunity	EN61000-4-3 20 V/m	Perf. Criteria A
Fast transient	EN61000-4-4 ± 2kV	Perf. Criteria A
Surge	EN61000-4-5 DM ± 1kV and CM ± 2kV	Perf. Criteria A
Conducted immunity	EN61000-4-6 20 Vr.m.s	Perf. Criteria A
Dip and interruptions	EN61000-4-11 and EN55024	

CHARACTERISTIC CURVE

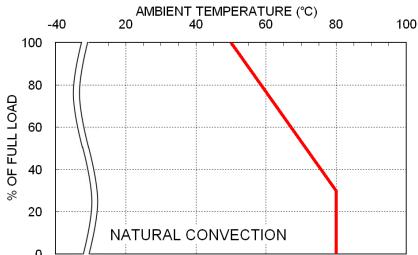

Derating Curve vs. Ambient Temperature
T□D100

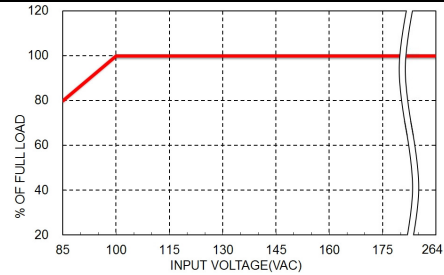

Derating Curve vs. Input Voltage
T□D100

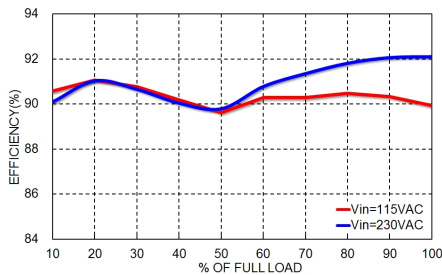

Efficiency vs. Output Load
T□D100US24

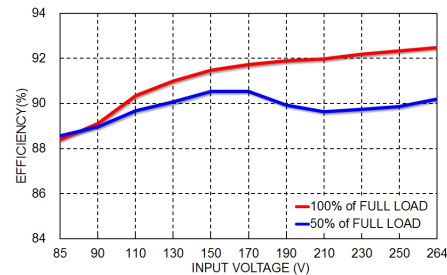

Efficiency vs. Input Voltage
T□D100US24

MECHANICAL DRAWING

TAD Open type mechanical drawing:

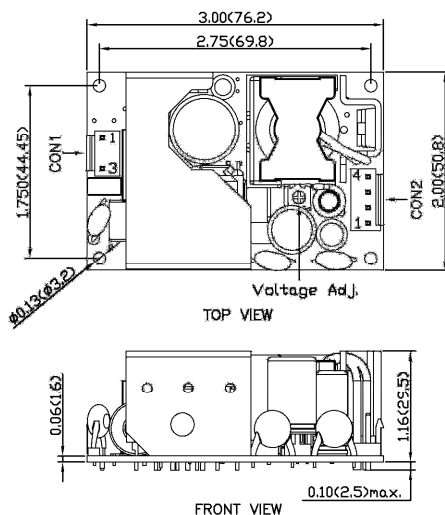

- All dimensions in inch (mm)
- Tolerance : x.xx±0.02 (x.x±0.5) x.xxx±0.01 (x.xx±0.25)
- M3×0.5 screw locked torque MAX 5Kgf.cm/0.49N.m

CON1 – Input Connector	
Pin 1	Line
Pin 3	Neutral
Mates with JST housing : VHR-3N JST crimp terminals : SVH-21T-P1.1	
Mounting holes marked with ⊕ must be connected to safety earth for CLASS I application	
CON2 – Output Connector	
Pin 1,2	-Vout
Pin 3,4	+Vout
Mates with JST housing : VHR-4N JST crimp terminals : SVH-21T-P1.1	

MECHANICAL DRAWING (CONTINUED)

TUD U chassis type mechanical drawing:

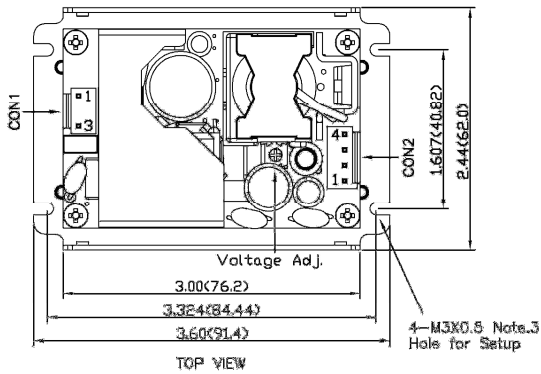

TED Enclosed type mechanical drawing:

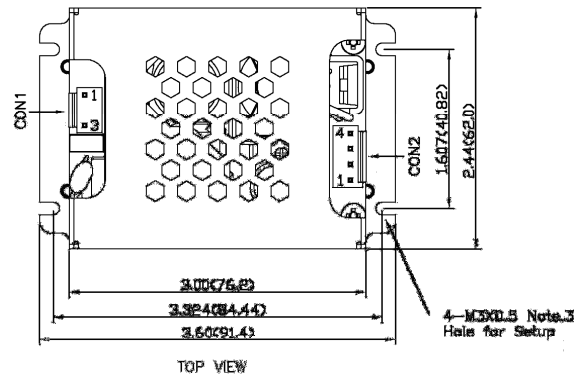

TDD Din rail type mechanical drawing:

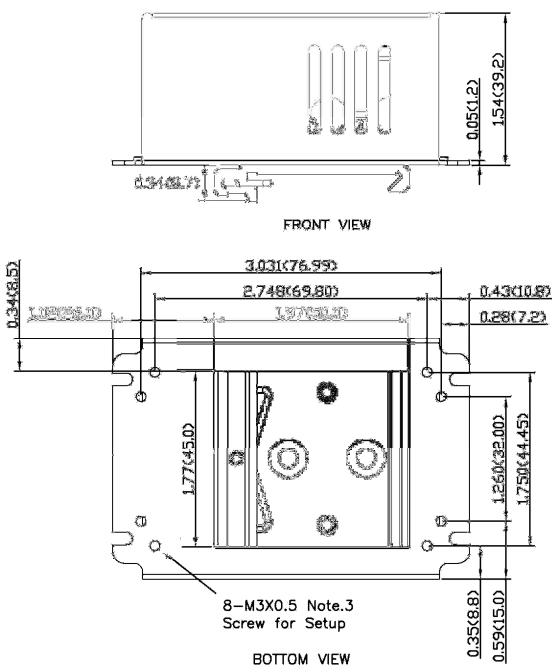

- Note:
1. All dimensions in inch (mm)
 2. Tolerance : x.xx±0.02 (x.x±0.5) x.xxx±0.01 (x.xx±0.25)
 3. M3×0.5 screw locked torque MAX 5Kgf.cm/0.49N.m