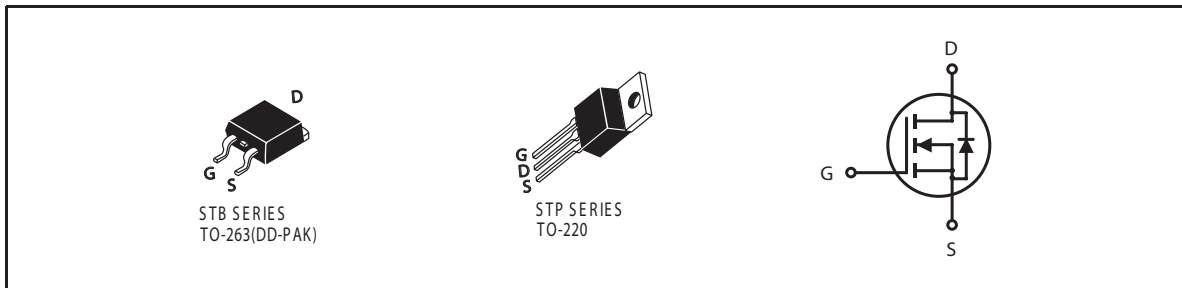

**N-Channel Logic Level Enhancement Mode Field Effect Transistor****PRODUCT SUMMARY**

V _{DS}	I _D	R _{DS(ON)} (mΩ) Typ
60V	80A	9.5 @ V _{GS} =10V
		13.5 @ V _{GS} =4.5V

FEATURES

- Super high dense cell design for extremely low R_{DS(ON)}.
- High power and current handling capability.
- TO-220 & TO-263 package.

**ABSOLUTE MAXIMUM RATINGS (T_A=25°C unless otherwise noted)**

Symbol	Parameter	Limit	Units
V _{DS}	Drain-Source Voltage	60	V
V _{GS}	Gate-Source Voltage	±20	V
I _D	Drain Current-Continuous ^a	T _C =25°C	80
		T _C =70°C	68
I _{DM}	-Pulsed ^b	250	A
E _{AS}	Single Pulse Avalanche Energy ^d	420	mJ
P _D	Maximum Power Dissipation ^a	T _C =25°C	130
		T _C =70°C	91
T _J , T _{STG}	Operating Junction and Storage Temperature Range	-55 to 175	°C

THERMAL CHARACTERISTICS

R _{θJC}	Thermal Resistance, Junction-to-Case ^a	1.15	°C/W
R _{θJA}	Thermal Resistance, Junction-to-Ambient ^a	62.5	°C/W

STB/P80L60

Ver2.0

ELECTRICAL CHARACTERISTICS (T_A=25°C unless otherwise noted)

Symbol	Parameter	Conditions	Min	Typ	Max	Units
OFF CHARACTERISTICS						
BV _{DSS}	Drain-Source Breakdown Voltage	V _{GS} =0V, I _D =250μA	60			V
I _{DSS}	Zero Gate Voltage Drain Current	V _{DS} =48V, V _{GS} =0V			1	μA
I _{GSS}	Gate-Body Leakage Current	V _{GS} = ±20V, V _{DS} =0V			±100	nA
ON CHARACTERISTICS						
V _{GS(th)}	Gate Threshold Voltage	V _{DS} =V _{GS} , I _D =250μA	1	2	3	V
R _{DS(ON)}	Drain-Source On-State Resistance	V _{GS} =10V, I _D =40A		9.5	12	m ohm
		V _{GS} =4.5V, I _D =35A		13.5	16	m ohm
g _{FS}	Forward Transconductance	V _{DS} =5V, I _D =40A		57		S
DYNAMIC CHARACTERISTICS °						
C _{ISS}	Input Capacitance	V _{DS} =25V, V _{GS} =0V f=1.0MHz		4300		pF
C _{OSS}	Output Capacitance			370		pF
C _{RSS}	Reverse Transfer Capacitance			235		pF
SWITCHING CHARACTERISTICS °						
t _{D(ON)}	Turn-On Delay Time	V _{DD} =30V I _D =1A V _{GS} =10V R _{GEN} =6 ohm		72		ns
t _r	Rise Time			74		ns
t _{D(OFF)}	Turn-Off Delay Time			152		ns
t _f	Fall Time			30		ns
Q _g	Total Gate Charge	V _{DS} =30V, I _D =25A, V _{GS} =10V		57.5		nC
		V _{DS} =30V, I _D =25A, V _{GS} =4.5V		26		nC
Q _{gs}	Gate-Source Charge	V _{DS} =30V, I _D =25A, V _{GS} =10V		7.2		nC
Q _{gd}	Gate-Drain Charge			17.5		nC
DRAIN-SOURCE DIODE CHARACTERISTICS AND MAXIMUM RATINGS						
V _{SD}	Diode Forward Voltage	V _{GS} =0V, I _S =8A		0.79	1.3	V

Notes

- Surface Mounted on FR4 Board, t ≤ 10sec.
- Pulse Test: Pulse Width ≤ 300us, Duty Cycle ≤ 2%.
- Guaranteed by design, not subject to production testing.
- Starting T_J=25°C, L=0.5mH, V_{DD} = 30V. (See Figure 13)

Sep, 17, 2010

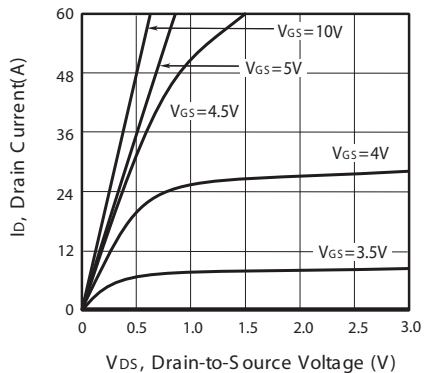

Figure 1. Output Characteristics

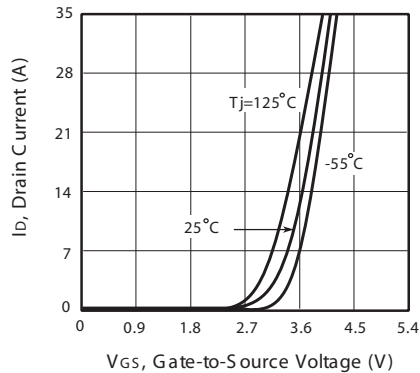

Figure 2. Transfer Characteristics

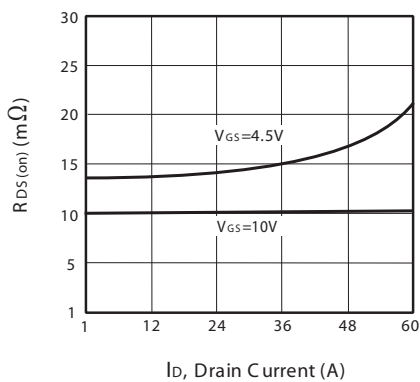

Figure 3. On-Resistance vs. Drain Current and Gate Voltage

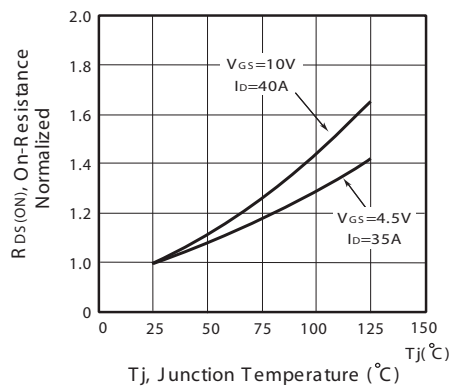

Figure 4. On-Resistance Variation with Drain Current and Temperature

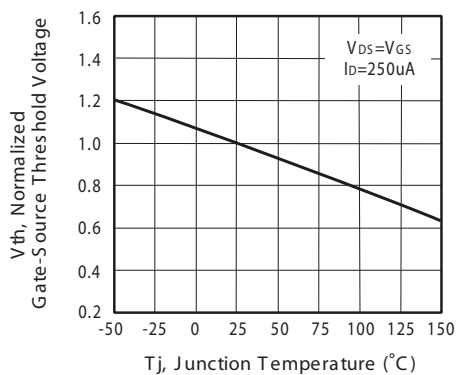

Figure 5. Gate Threshold Variation with Temperature

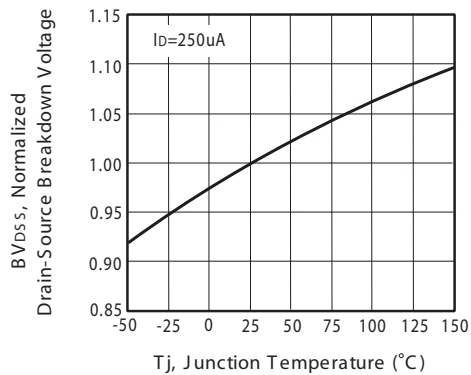

Figure 6. Breakdown Voltage Variation with Temperature

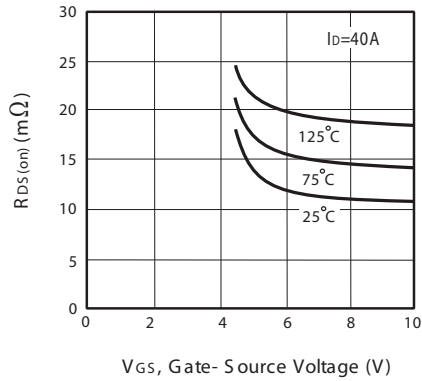

Figure 7. On-Resistance vs. Gate-Source Voltage

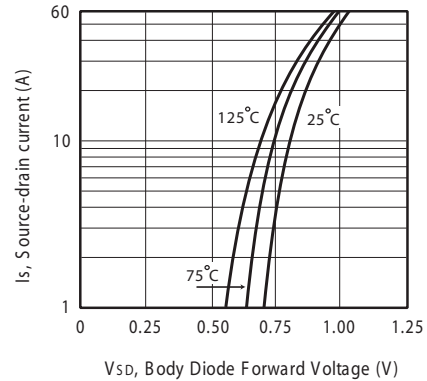

Figure 8. Body Diode Forward Voltage Variation with Source Current

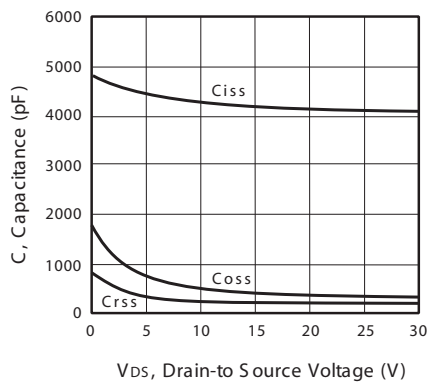

Figure 9. Capacitance

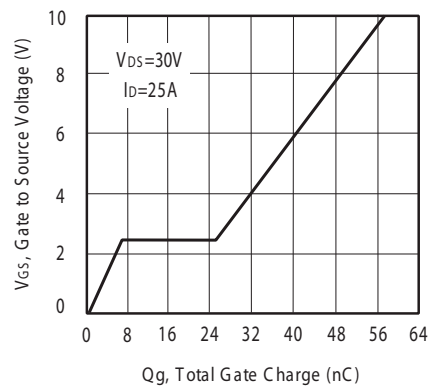

Figure 10. Gate Charge

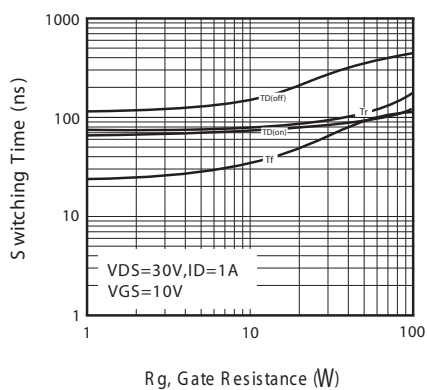

Figure 11. switching characteristics

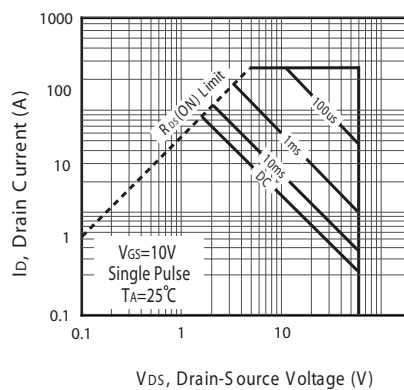
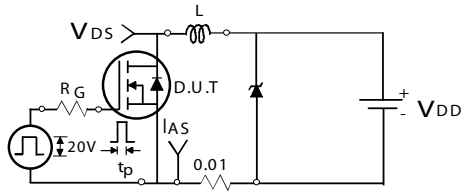
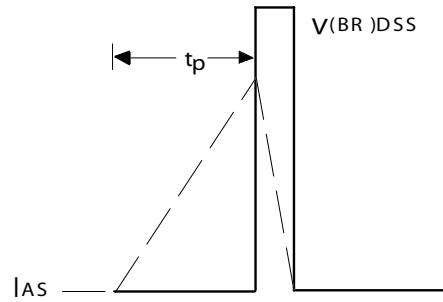

Figure 12. Maximum Safe Operating Area



Unclamped Inductive Test Circuit

Figure 13a.



Unclamped Inductive Waveforms

Figure 13b.

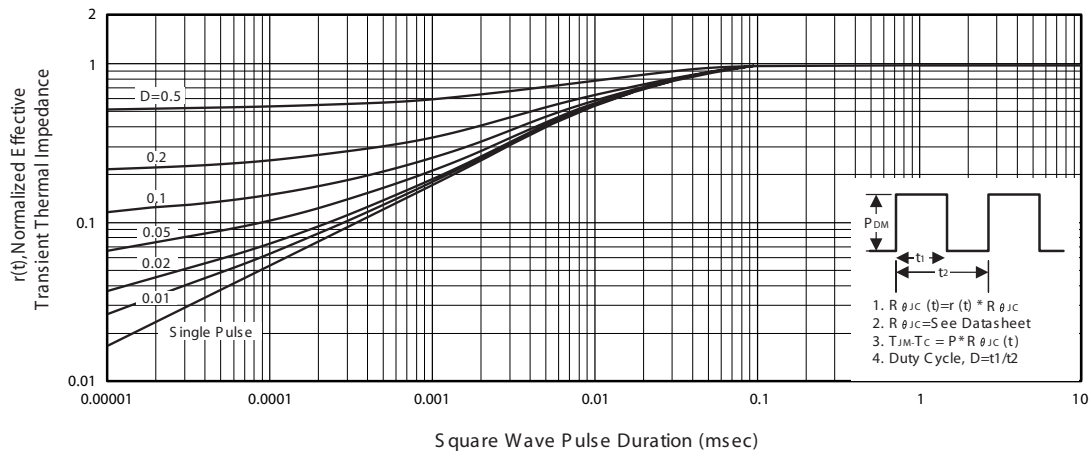

Figure 14. Normalized Thermal Transient Impedance Curve

STB/P80L60

Ver2.0

PACKAGE OUTLINE DIMENSIONS

TO-220

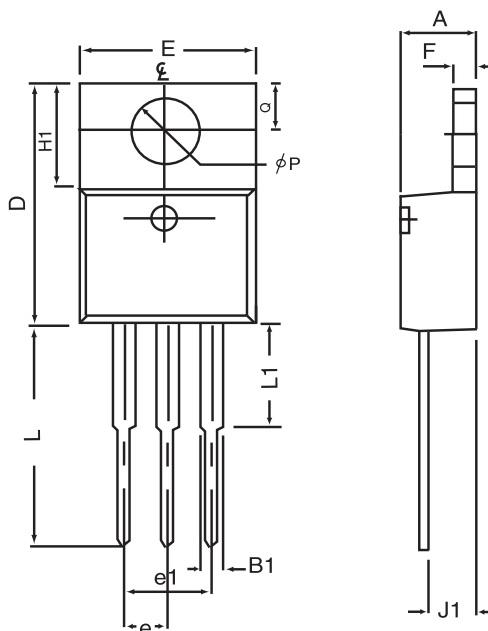

SYMBOLS	MILLIMETERS		INCHES	
	MIN	MAX	MIN	MAX
A	4.32	4.80	0.170	0.189
B1	1.27	1.65	0.050	0.630
D	14.6	16.00	0.575	0.610
E	9.70	10.41	0.382	0.410
e	2.34	2.74	0.092	0.108
e1	4.68	5.48	0.184	0.216
F	1.14	1.40	0.045	0.055
H1	5.97	6.73	0.235	0.265
J1	2.20	2.79	0.087	0.110
L	12.88	14.22	0.507	0.560
L1	3.00	6.35	0.120	0.250
ϕP	3.50	3.94	0.138	0.155
Q	2.54	3.05	0.100	0.120

Sep,17,2010

PACKAGE OUTLINE DIMENSIONS

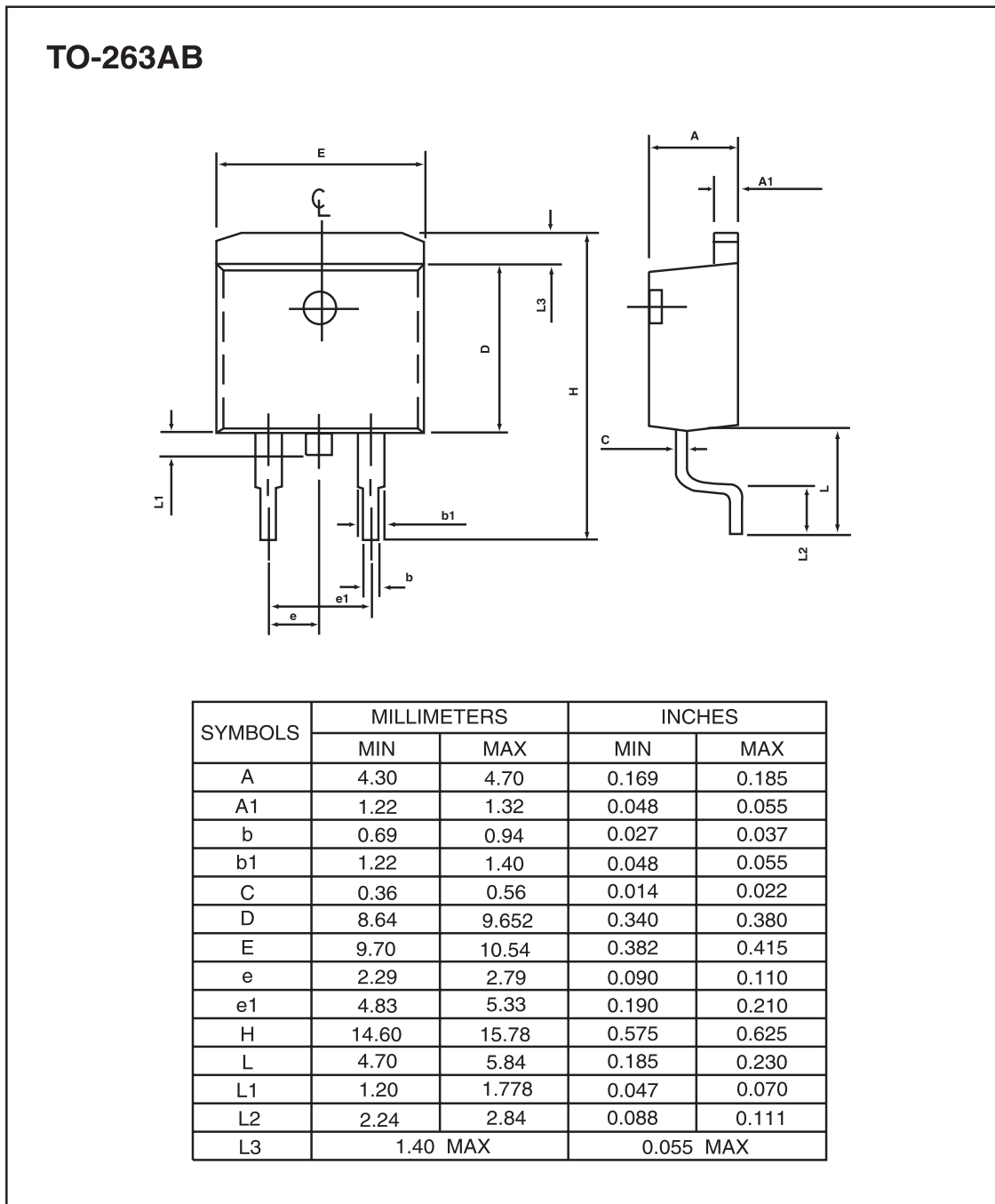

STB/P80L60

Ver2.0

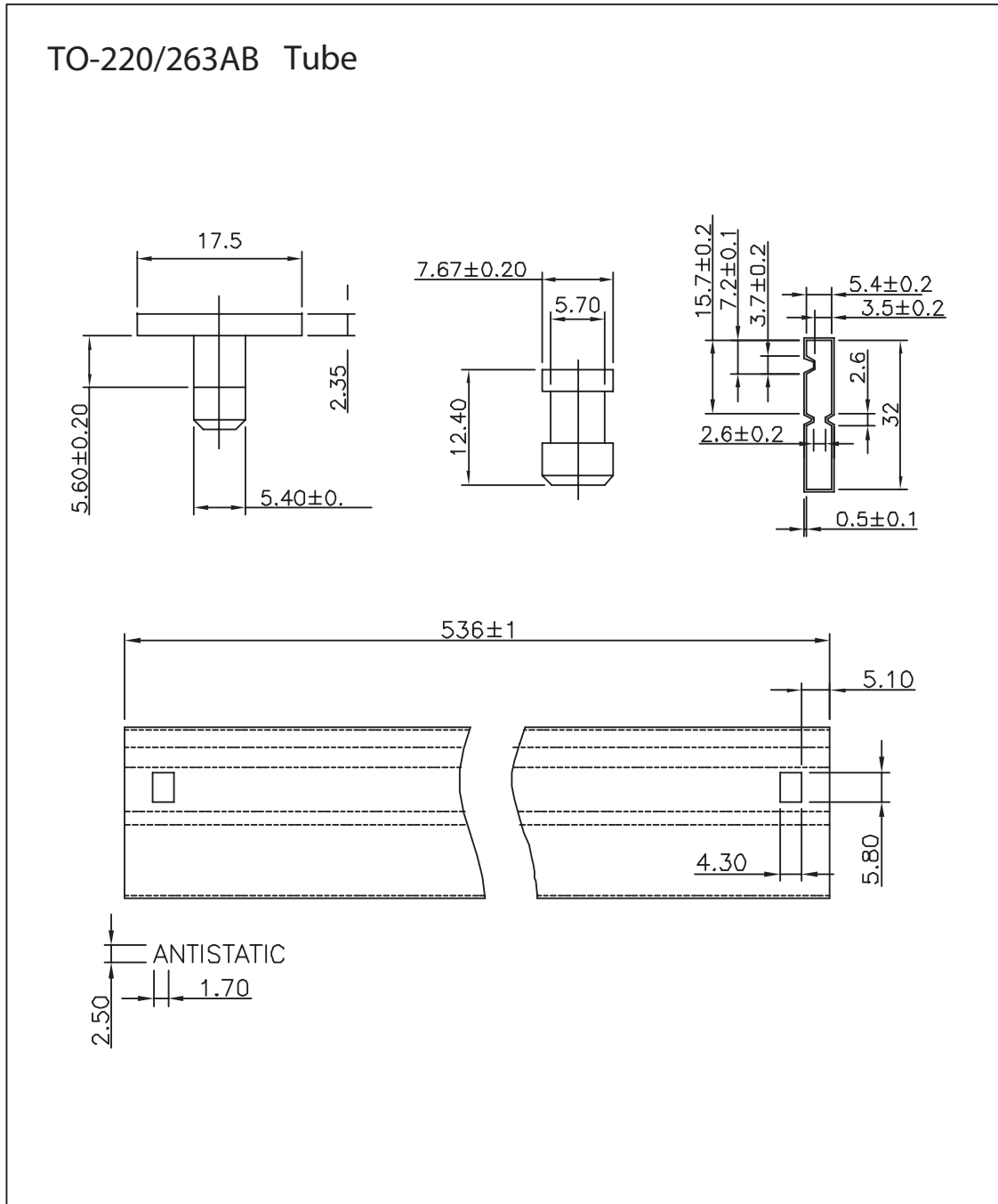

Sep,17,2010