

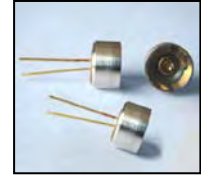

LED20-PR

TECHNICAL DATA



Mid-Infrared Light Emitting Diode

Light Emitting Diodes with central wavelength 2.05 µm series are based on heterostructures grown on GaSb substrates by MOCVD. GaInAsSb is used in the active layer. Wide band gap solid solutions AlGaAsSb are used for good electron confinement.

LED20-PR has a stable output power and a lifetime more than 80000 hours.

Specifications

- Structure: GaInAsSb/AlGaAsSb
- Peak Wavelength: typ. 2.05 µm
- Optical Output Power: typ. 1.0 mW qCW
- Package: TO-18 with PR and without window

Absolute Maximum Ratings ($T_A=25^\circ\text{C}$)

Item	Condition	Value			Unit
		Min.	Typ.	Max.	
Peak Wavelength	T=300 K	2.00	2.05	2.09	µm
FWHM	150 mA qCW	0.15	0.20	0.25	µm
Quasi-CW Optical Power	200 mA qCW	0.8	1.0	1.2	mW
Pulsed Optical Power	I=1 A, f=1 Hz, d.c. 0.1%	20	25	30	mW
Switching Time	T=300 K	10	20	30	ns
Operation Voltage	200 mA qCW	0.5	-	1.5	V
Operating Temperature		-200 ... +50			°C
Emitting Area		300 x 300			µm
Soldering Temperature		180			°C
Package	TO-18, with parabol reflector and without window				

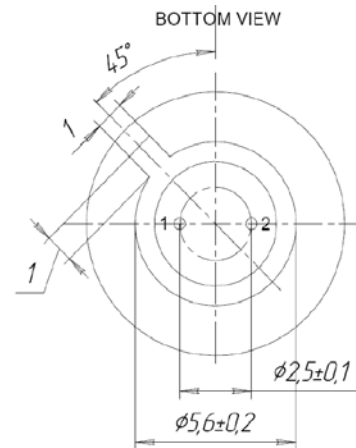
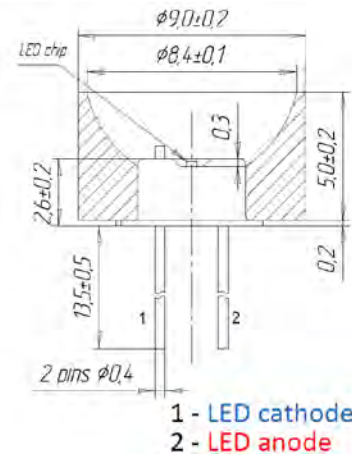

(Unit: mm)

Operation Instructions

- LED basic circuit connection

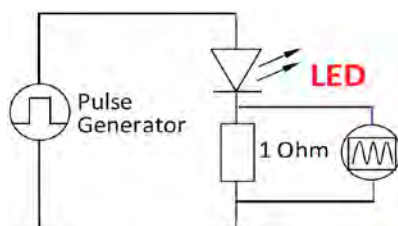

- We recommend to use one of our drivers and evaluation boards designed for those Mid-IR LEDs

D-11, D-31, D-31M

DLT-27, DLT-37

mD-1c, mD-1p



We recommend to use **Quasi Continuous Wave (qCW) mode** with duty cycle 50% or 25% to obtain maximum average optical power and short **Pulse mode** to obtain maximum peak power.

Hard CW (continues wave) mode is NOT recommended.

- **Quasi CW Mode**

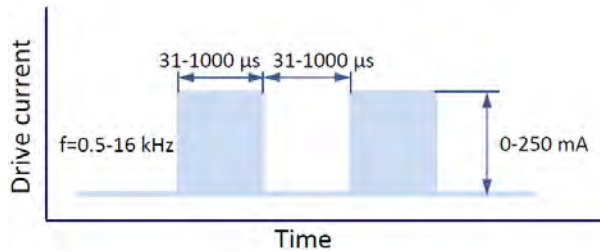

- **Pulsed Mode**

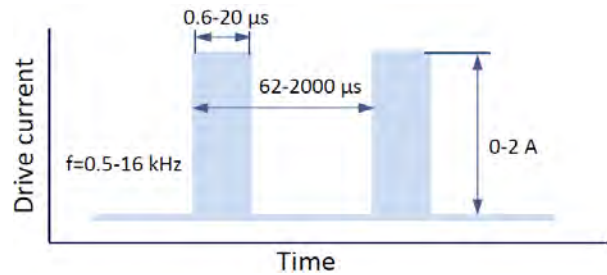

Typical Performance Curves

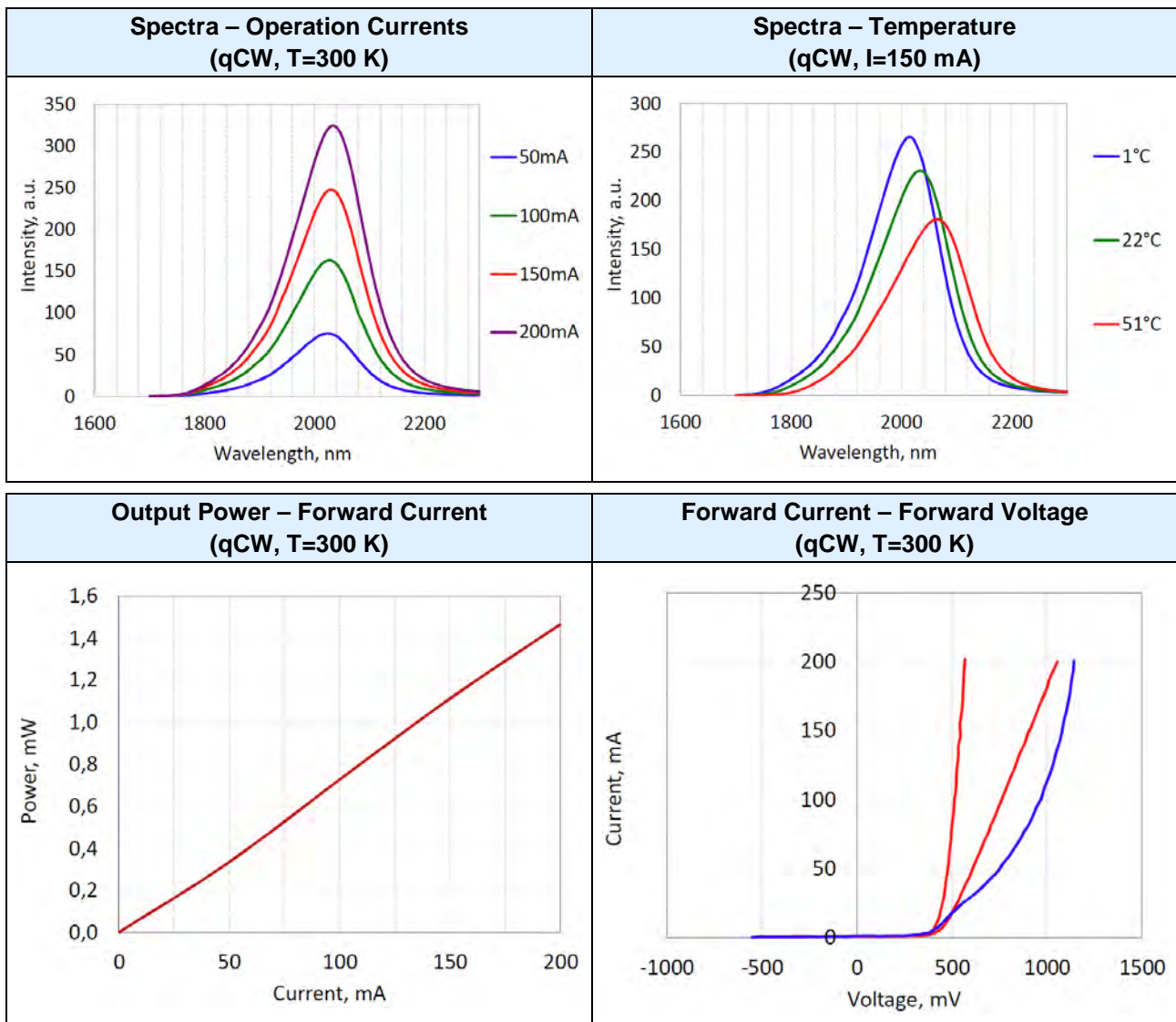



Beam Divergence (Far-Field Pattern)

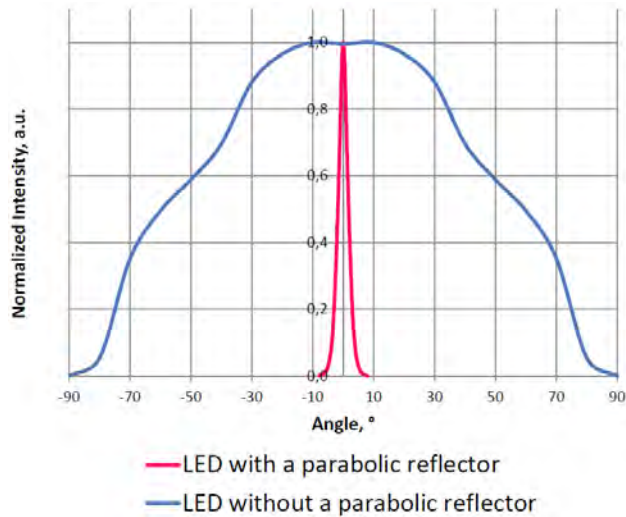

Note: The above specifications are for reference purpose only and subjected to change without prior notice.

Precaution for Use

1. Cautions

- Check your connection circuits before turning on the LED.
- Observe the LED polarity: LED anode is marked with a RED dot.
- **DO NOT** connect the LED to the multimeter!

2. Soldering Conditions

- DO NOT apply any stress to the lead particularly when heat.
- After soldering the LEDs should be protected from mechanical shock or vibration until the LEDs return to room temperature.
- When it is necessary to clamp the LEDs to prevent soldering failure, it is important to minimize the mechanical stress on the LEDs.

3. Static Electricity

- The LEDs are very sensitive to Static Electricity and surge voltage. So it is recommended that a wrist band and/or an anti-electrostatic glove be used when handling the LEDs.
- All devices, equipment and machinery must be grounded properly. It is recommended that precautions should be taken against surge voltage to the equipment that mounts the LEDs.



4. Heat Generation

- Thermal design of the end product is of paramount importance. Please consider the heat generation of the LED when making the system design. The coefficient of temperature increase per input electric power is affected by the thermal resistance of the circuit board and density of LED placement on the board, as well as other components. It is necessary to avoid intense heat generation and operate within the maximum ratings given in the specification.
- The operating current should be decided after considering the ambient maximum temperature of LEDs.