

## SWITCHING REGULATOR APPLICATION

### Features

- $BV_{DSS}=800V$  (Min.)
- Low gate charge:  $Q_g=19nC$  (Typ.)
- Low drain-source On resistance:  $R_{DS(on)}=4.2\Omega$  (Max.)
- RoHS compliant device
- 100% avalanche tested

### Ordering Information

Part Number	Marking	Package
SMN03T80F	SMN03T80	TO-220F-3L

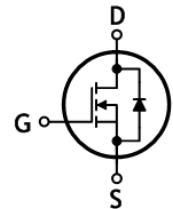
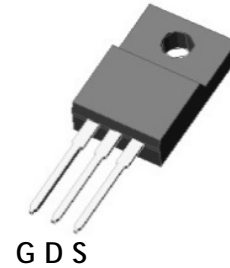

TO-220F-3L

### Marking Information

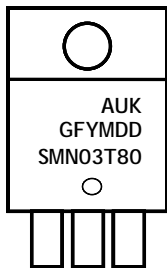

Column 1 : Manufacturer  
 Column 2 : Production Information  
 e.g.) GFYMDD  
 -. G : Option Code (H : Halogen Free)  
 -. F : Factory Management Code  
 -. YMDD : Date Code (Year, Month, Date)  
 Column 3 : Device Code

### Absolute maximum ratings ( $T_C=25^\circ C$ unless otherwise noted)

Characteristic	Symbol	Rating	Unit	
Drain-source voltage	$V_{DSS}$	800	V	
Gate-source voltage	$V_{GSS}$	$\pm 30$	V	
Drain current (DC) *	$I_D$	$T_C=25^\circ C$	3	A
		$T_C=100^\circ C$	1.83	A
Drain current (Pulsed) *	$I_{DM}$	12	A	
Single pulsed avalanche energy <sup>(Note 2)</sup>	$E_{AS}$	200	mJ	
Repetitive avalanche current <sup>(Note 1)</sup>	$I_{AR}$	3	A	
Repetitive avalanche energy <sup>(Note 1)</sup>	$E_{AR}$	2.8	mJ	
Power dissipation	$P_D$	28	W	
Junction temperature	$T_J$	150	$^\circ C$	
Storage temperature range	$T_{stg}$	-55~150	$^\circ C$	

\* Limited only maximum junction temperature

## Thermal Characteristics

Characteristic	Symbol	Rating	Unit
Thermal resistance, junction to case	$R_{th(j-c)}$	Max. 4.46	°C/W
Thermal resistance, junction to ambient	$R_{th(j-a)}$	Max. 62.5	

## Electrical Characteristics ( $T_C=25^\circ\text{C}$ unless otherwise noted)

Characteristic	Symbol	Test Condition	Min.	Typ.	Max.	Unit
Drain-source breakdown voltage	$BV_{DSS}$	$I_D=250\mu\text{A}, V_{GS}=0$	800	-	-	V
Gate threshold voltage	$V_{GS(th)}$	$I_D=250\mu\text{A}, V_{DS}=V_{GS}$	2	-	4	V
Drain-source cut-off current	$I_{DSS}$	$V_{DS}=800\text{V}, V_{GS}=0\text{V}$	-	-	10	$\mu\text{A}$
		$V_{DS}=640\text{V}, T_C=125^\circ\text{C}$	-	-	100	$\mu\text{A}$
Gate leakage current	$I_{GSS}$	$V_{DS}=0\text{V}, V_{GS}=\pm 30\text{V}$	-	-	$\pm 100$	nA
Drain-source on-resistance <sup>(Note 3)</sup>	$R_{DS(ON)}$	$V_{GS}=10\text{V}, I_D=1.5\text{A}$	-	3.36	4.2	$\Omega$
Forward transfer conductance <sup>(Note 3)</sup>	$g_{fs}$	$V_{DS}=30\text{V}, I_D=1.5\text{A}$	-	3.7	-	S
Internal gate resistance	$R_G$	$f=1\text{MHz}, V_{DS}=0\text{V}$	-	3	10	$\Omega$
Input capacitance	$C_{iss}$	$V_{DS}=25\text{V}, V_{GS}=0\text{V}, f=1.0\text{MHz}$	-	696	-	pF
Output capacitance	$C_{oss}$		-	65	-	
Reverse transfer capacitance	$C_{rss}$		-	10.2	-	
Turn-on delay time <sup>(Note 3,4)</sup>	$t_{d(on)}$	$V_{DD}=400\text{V}, I_D=3\text{A}, R_G=25\Omega$	-	48	-	ns
Rise time <sup>(Note 3,4)</sup>	$t_r$		-	36	-	
Turn-off delay time <sup>(Note 3,4)</sup>	$t_{d(off)}$		-	106	-	
Fall time <sup>(Note 3,4)</sup>	$t_f$		-	41	-	
Total gate charge <sup>(Note 3,4)</sup>	$Q_g$	$V_{DS}=640\text{V}, V_{GS}=10\text{V}, I_D=3\text{A}$	-	19	-	nC
Gate-source charge <sup>(Note 3,4)</sup>	$Q_{gs}$		-	4	-	
Gate-drain charge <sup>(Note 3,4)</sup>	$Q_{gd}$		-	7.6	-	

## Source-Drain Diode Ratings and Characteristics ( $T_C=25^\circ\text{C}$ unless otherwise noted)

Characteristic	Symbol	Test Condition	Min.	Typ.	Max.	Unit
Source current (DC)	$I_S$	Integral reverse diode in the MOSFET	-	-	3	A
Source current (Pulsed)	$I_{SM}$		-	-	12	A
Forward voltage	$V_{SD}$	$V_{GS}=0\text{V}, I_S=3\text{A}$	-	-	1.5	V
Reverse recovery time <sup>(Note 3,4)</sup>	$t_{rr}$	$I_S=3\text{A}, V_{GS}=0\text{V}, di_F/dt=100\text{A}/\mu\text{s}$	-	372	-	ns
Reverse recovery charge <sup>(Note 3,4)</sup>	$Q_{rr}$		-	1.8	-	$\mu\text{C}$

Note:

1. Repeated rating: Pulse width limited by safe operating area
2.  $L=42\text{mH}, I_{AS}=3\text{A}, V_{DD}=50\text{V}, R_G=25\Omega$ , Starting  $T_J=25^\circ\text{C}$
3. Pulse test: Pulse width  $\leq 300\mu\text{s}$ , Duty cycle  $\leq 2\%$
4. Essentially independent of operating temperature typical characteristics

## Electrical Characteristic Curves

Fig. 1  $I_D - V_{DS}$

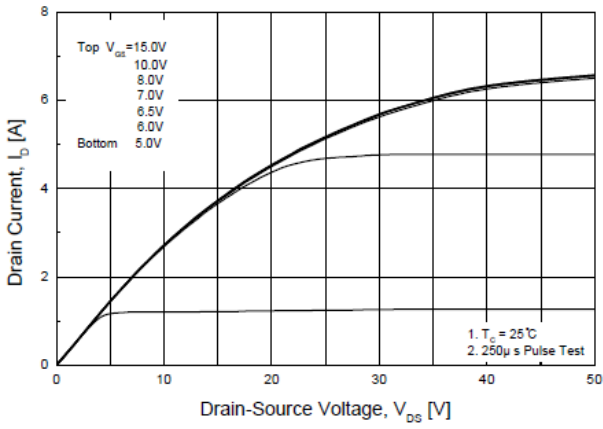

Fig. 2  $I_D - V_{GS}$

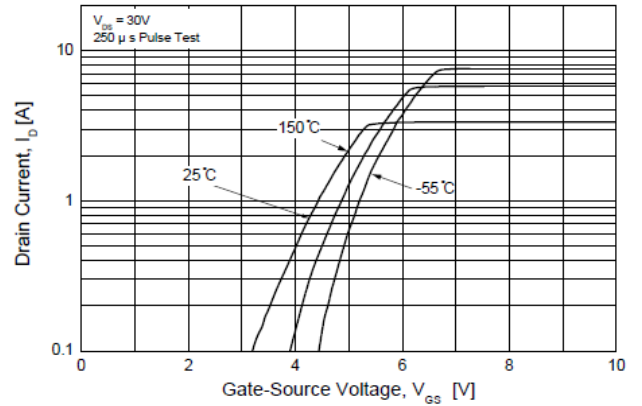

Fig. 3  $R_{DS(ON)} - I_D$

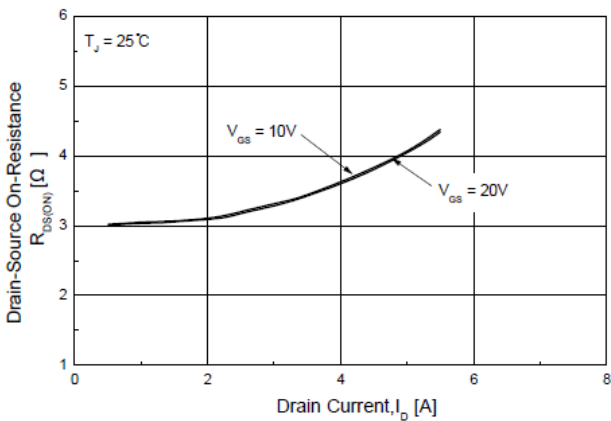

Fig. 4  $I_{DR} - V_{SD}$

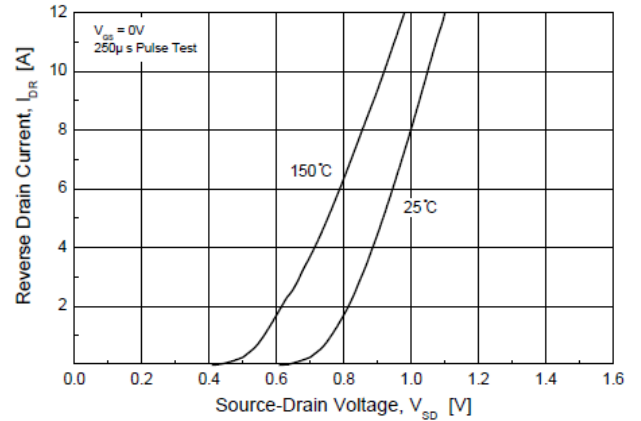

Fig. 5 Capacitance -  $V_{DS}$

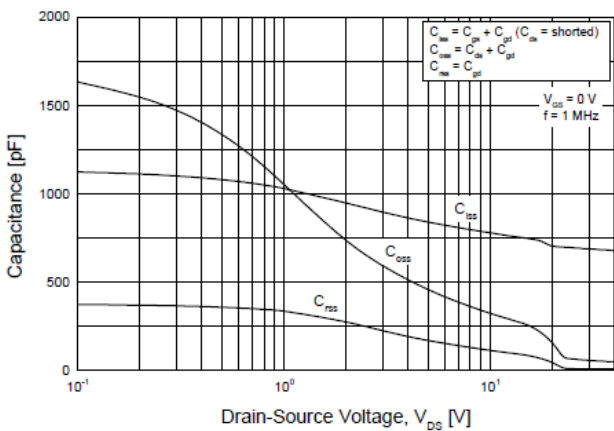
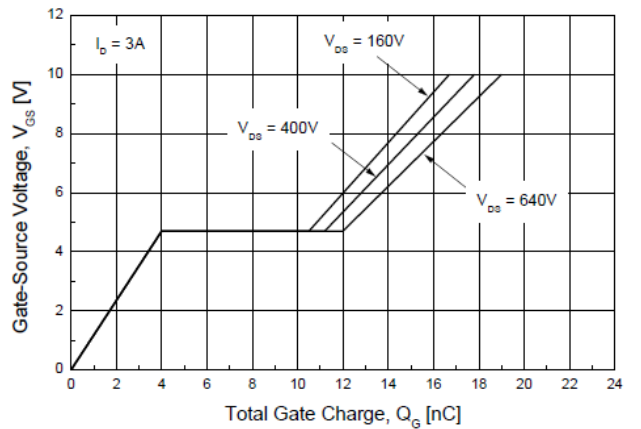

Fig. 6  $V_{GS} - Q_G$



Electrical Characteristic Curves (Continue)

Fig. 7  $BV_{DSS} - T_J$

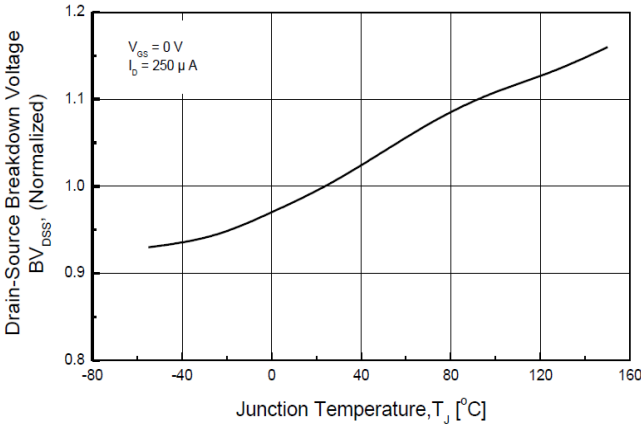

Fig. 8  $R_{DS(ON)} - T_J$

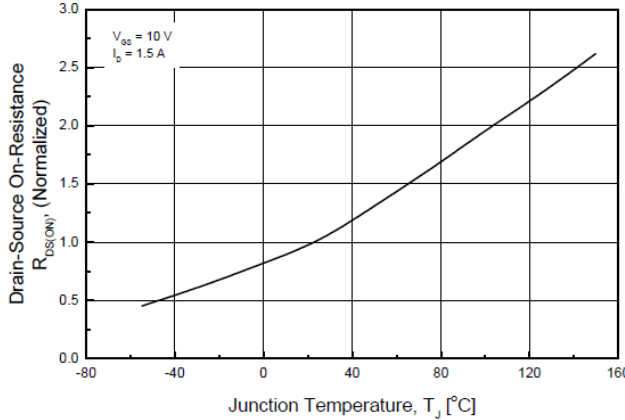

Fig. 9  $I_D - T_C$

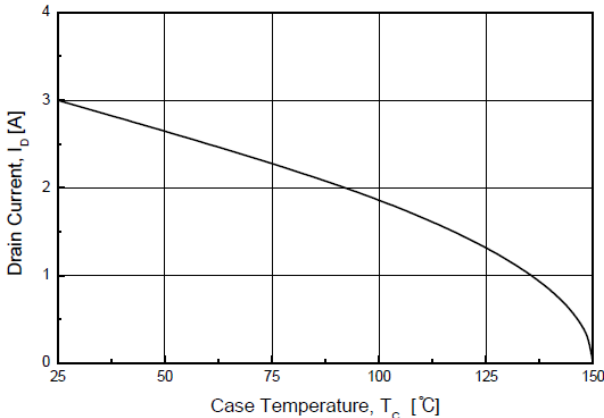

Fig. 10  $V_{GS(th)} - T_J$

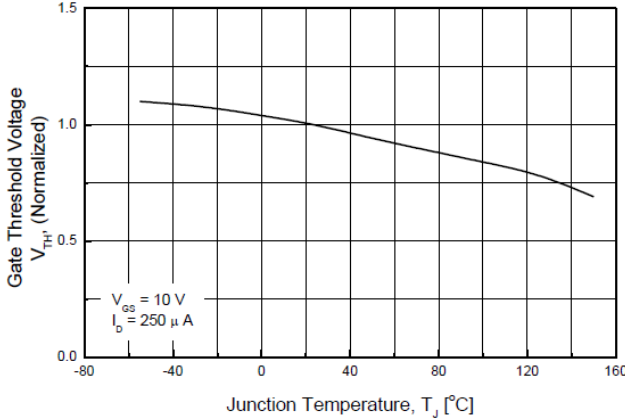

Fig. 11 Safe Operating Area

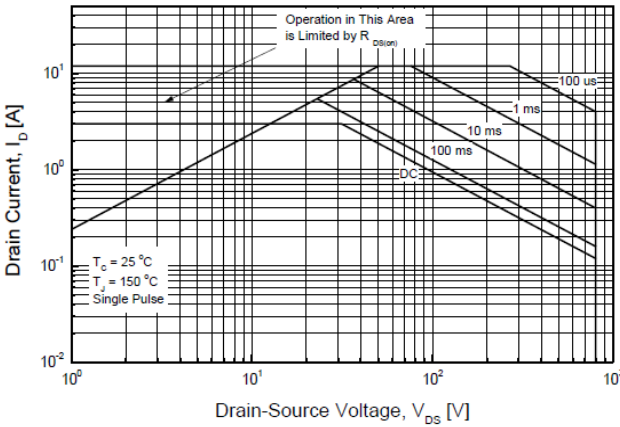

Fig. 12 Gate Charge Test Circuit & Waveform

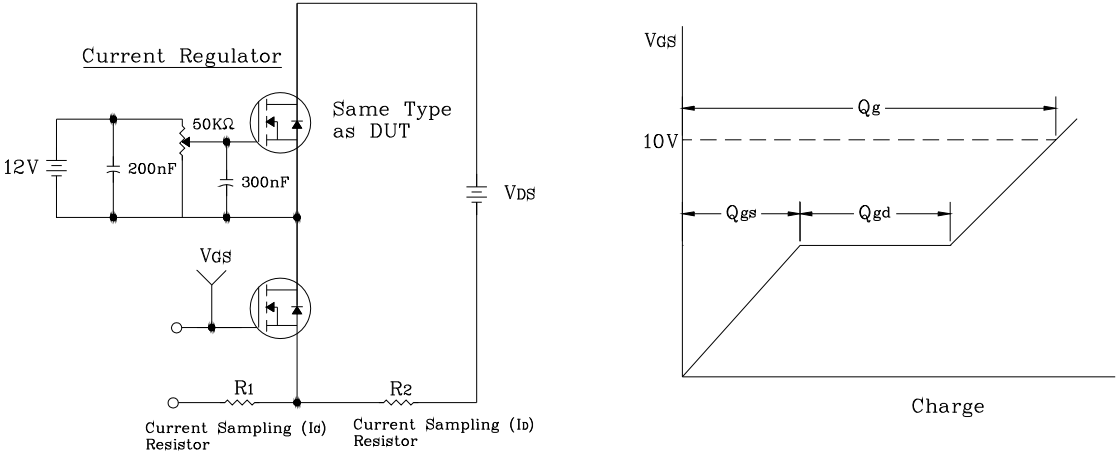

Fig. 13 Resistive Switching Test Circuit & Waveform

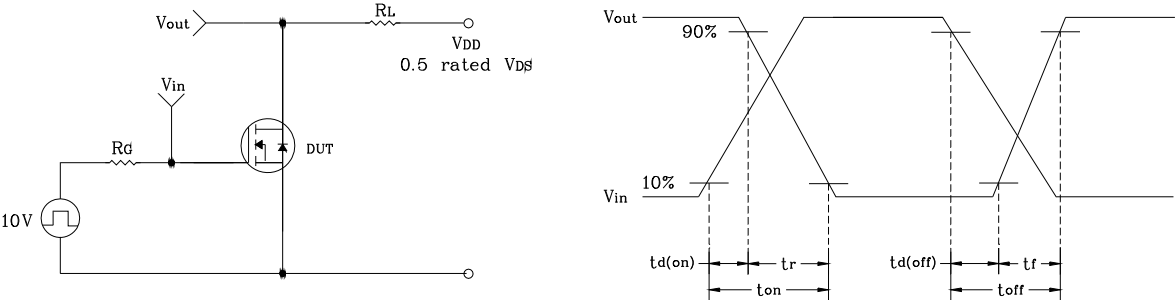

Fig. 14 E<sub>AS</sub> Test Circuit & Waveform

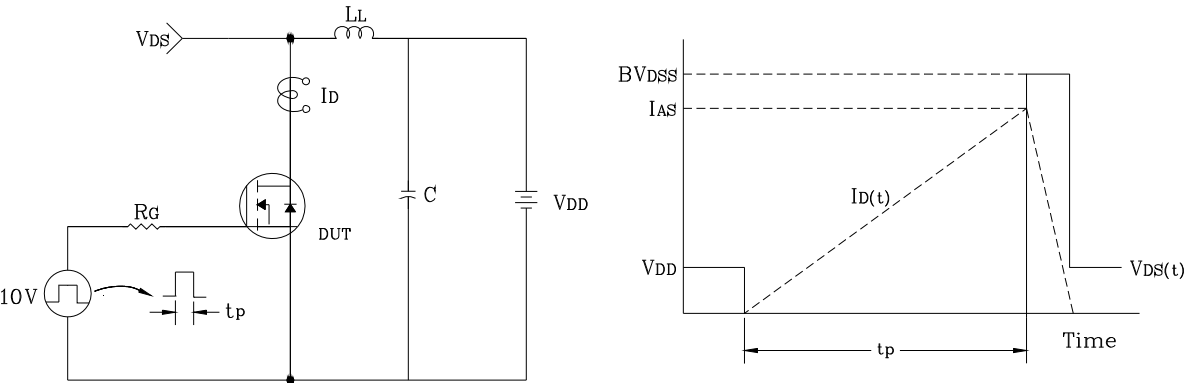
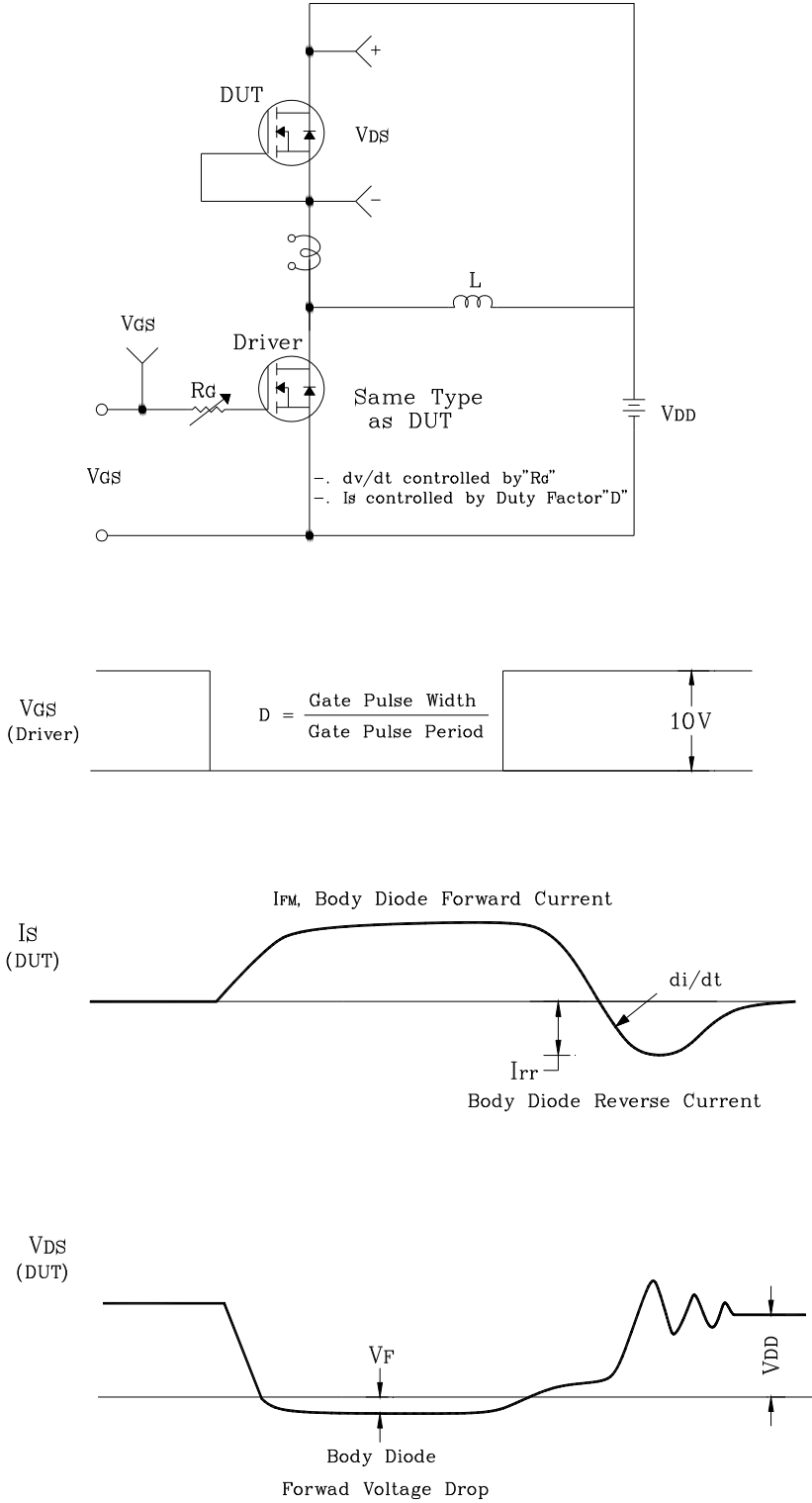
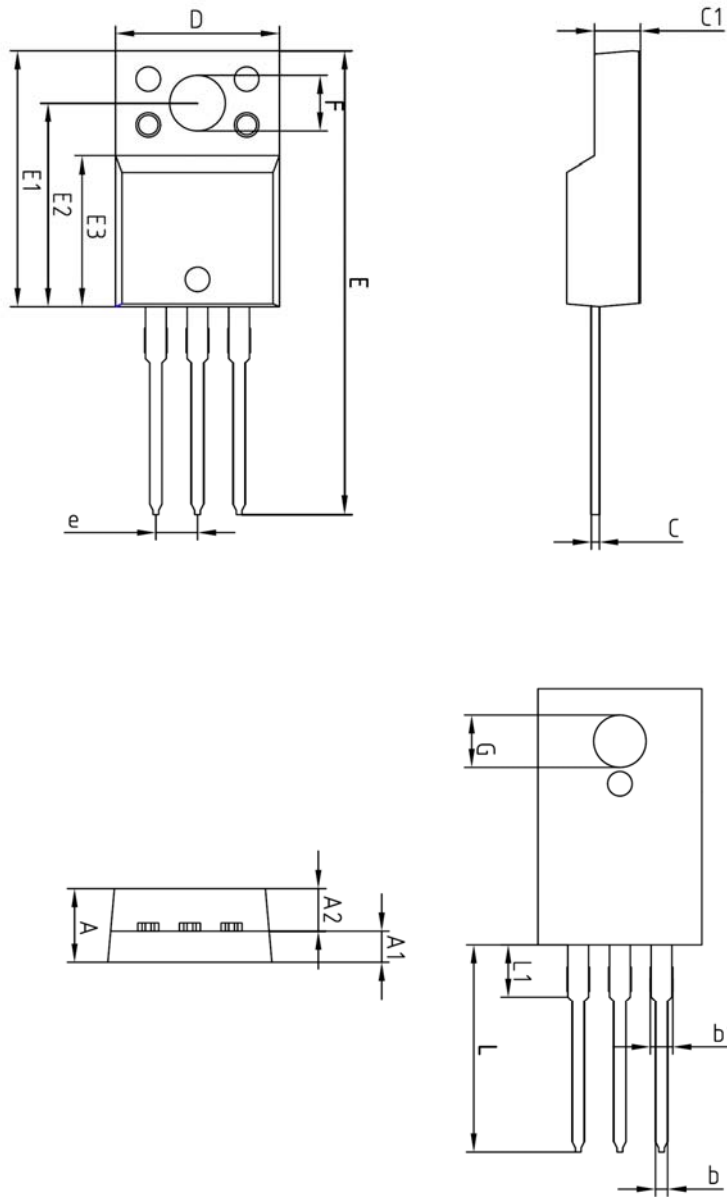

Fig. 15 Diode Reverse Recovery Time Test Circuit & Waveform



## Package Outline Dimensions



SYMBOL	MILLIMETERS			NOTE
	MINIMUM	NOMINAL	MAXIMUM	
A	-	-	4.60	
A1	2.45	2.50	2.55	
A2	1.95	2.00	2.05	
b	0.65	0.75	0.85	
b1	1.07	1.27	1.47	
C	0.40	0.50	0.60	
C1	2.70	2.80	2.90	
D	9.90	10.00	10.10	
E	28.00	-	28.60	
E1	15.50	15.60	15.70	
E2	12.30	12.40	12.50	
E3	9.15	9.20	9.25	
F	3.30	3.40	3.50	
G	3.10	3.20	3.30	
e	2.54 BSC			
L	12.40	-	13.00	
L1	3.46 BSC			

**The AUK Corp. products are intended for the use as components in general electronic equipment (Office and communication equipment, measuring equipment, home appliance, etc.).**

**Please make sure that you consult with us before you use these AUK Corp. products in equipments which require high quality and / or reliability, and in equipments which could have major impact to the welfare of human life(atomic energy control, airplane, spaceship, transportation, combustion control, all types of safety device, etc.). AUK Corp. cannot accept liability to any damage which may occur in case these AUK Corp. products were used in the mentioned equipments without prior consultation with AUK Corp..**

**Specifications mentioned in this publication are subject to change without notice.**