



PJU4NA65H / PJD4NA65H / PJP4NA65H / PJF4NA65H

650V N-Channel MOSFET

Voltage

650 V

Current

3 A

Features

- $R_{DS(ON)}$, $V_{GS}@10V, I_D@1.5A < 3.75\Omega$
- High switching speed
- Improved dv/dt capability
- Low Gate Charge
- Low reverse transfer capacitance
- Lead free in compliance with EU RoHS 2011/65/EU directive.
- Green molding compound as per IEC61249 Std.
(Halogen Free)

Mechanical Data

- Case : TO-251AB, TO-252, TO-220AB, ITO-220AB-F Package
- Terminals : Solderable per MIL-STD-750, Method 2026
- TO-251AB Approx. Weight : 0.0104 ounces, 0.297grams
- TO-252 Approx. Weight : 0.0104 ounces, 0.297grams
- TO-220AB Approx. Weight : 0.067 ounces, 1.89 grams
- ITO-220AB-F Approx. Weight : 0.068 ounces, 2 grams

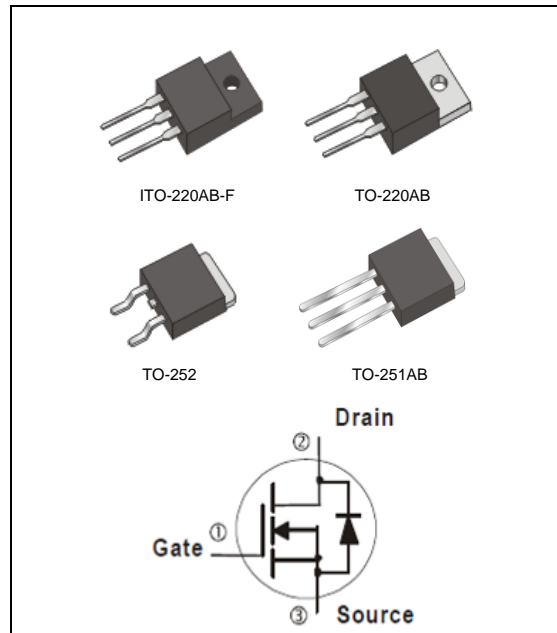

Maximum Ratings and Thermal Characteristics ($T_A=25^\circ\text{C}$ unless otherwise noted)

PARAMETER		SYMBOL	TO-251AB	TO-220AB	ITO-220AB-F	TO-252	UNITS
Drain-Source Voltage		V_{DS}	650				V
Gate-Source Voltage		V_{GS}	± 30				V
Continuous Drain Current		I_D	3				A
Pulsed Drain Current		I_{DM}	12				A
Single Pulse Avalanche Energy ^(Note 1)		E_{AS}	125				mJ
Power Dissipation	$T_C=25^\circ\text{C}$	P_D	34	44	23	34	W
	Derate above 25°C		0.27	0.35	0.18	0.27	W/ $^\circ\text{C}$
Operating Junction and Storage Temperature Range		T_J, T_{STG}	-55~150				$^\circ\text{C}$
Typical Thermal resistance							
- Junction to Case		$R_{\theta JC}$	3.68	2.84	5.43	3.67	$^\circ\text{C}/\text{W}$
- Junction to Ambient		$R_{\theta JA}$	110	62.5	120	110	

- Limited only By Maximum Junction Temperature



PJU4NA65H / PJD4NA65H / PJP4NA65H / PJF4NA65H

Electrical Characteristics ($T_A=25^\circ\text{C}$ unless otherwise noted)

PARAMETER	SYMBOL	TEST CONDITION	MIN.	TYP.	MAX.	UNITS
Static						
Drain-Source Breakdown Voltage	BV_{DSS}	$V_{GS}=0V, I_D=250\mu A$	650	-	-	V
Gate Threshold Voltage	$V_{GS(th)}$	$V_{DS}=V_{GS}, I_D=250\mu A$	2	-	4	V
Drain-Source On-State Resistance	$R_{DS(on)}$	$V_{GS}=10V, I_D=1.5A$	-	3.2	3.75	Ω
Zero Gate Voltage Drain Current	I_{DSS}	$V_{DS}=650V, V_{GS}=0V$	-	-	1.0	μA
Gate-Source Leakage Current	I_{GSS}	$V_{GS}=\pm 30V, V_{DS}=0V$	-	-	± 100	nA
Diode Forward Voltage	V_{SD}	$I_S=3A, V_{GS}=0V$	-	0.83	1.4	V
Dynamic (Note 4)						
Total Gate Charge	Q_g	$V_{DS}=520V, I_D=3A,$ $V_{GS}=10V$ (Note 2,3)	-	16.1	-	nC
Gate-Source Charge	Q_{gs}		-	2.5	-	
Gate-Drain Charge	Q_{gd}		-	7	-	
Input Capacitance	C_{iss}	$V_{DS}=25V, V_{GS}=0V,$ $f=1.0\text{MHz}$	-	423	-	pF
Output Capacitance	C_{oss}		-	55	-	
Reverse Transfer Capacitance	C_{rss}		-	3.6	-	
Turn-On Delay Time	$t_{d(on)}$	$V_{DD}=325V, I_D=3A,$ $R_G=25\Omega$ (Note 2,3)	-	8.6	-	ns
Turn-On Rise Time	t_r		-	29	-	
Turn-Off Delay Time	$t_{d(off)}$		-	42	-	
Turn-Off Fall Time	t_f		-	31	-	
Drain-Source Diode						
Maximum Continuous Drain-Source Diode Forward Current	I_S	---	-	-	3	A
Maximum Pulsed Drain-Source Diode Forward Current	I_{SM}	---	-	-	12	A
Reverse Recovery Time	t_{rr}	$V_{GS}=0V, I_S=3A$	-	224	-	ns
Reverse Recovery Charge	Q_{rr}	$di_f/dt=100A/\mu s$ (Note 2)	-	1.8	-	μC

NOTES :

1. $L=30\text{mH}, I_{AS}=2.8A, V_{DD}=50V, R_G=25\text{ohm}$, Starting $T_J=25^\circ\text{C}$
2. Pulse width $\leq 300\mu s$, Duty cycle $\leq 2\%$
3. Essentially independent of operating temperature typical characteristics.
4. Guaranteed by design, not subject to production testing



PJU4NA65H / PJD4NA65H / PJP4NA65H / PJF4NA65H

TYPICAL CHARACTERISTIC CURVES

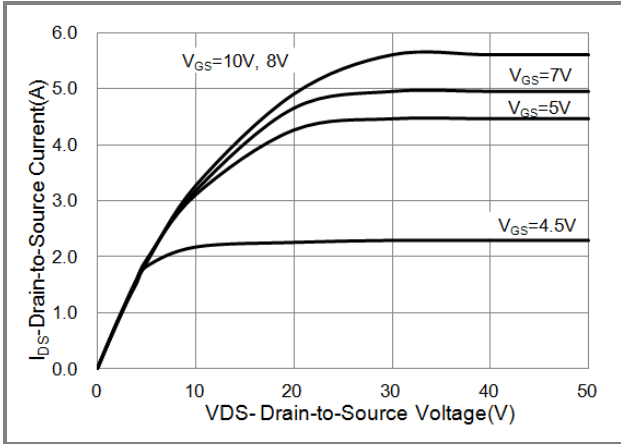

Fig.1 Output Characteristics

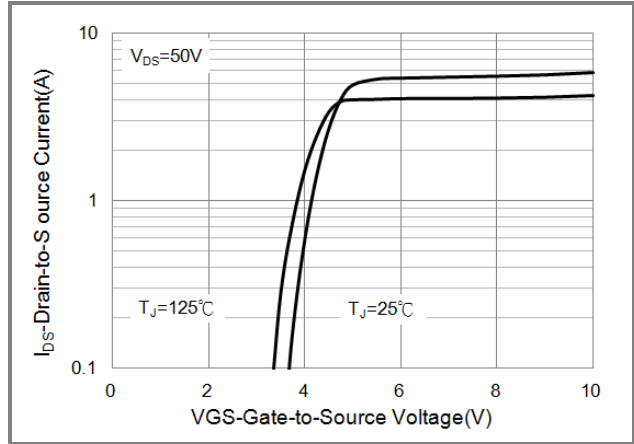

Fig.2 Transfer Characteristics

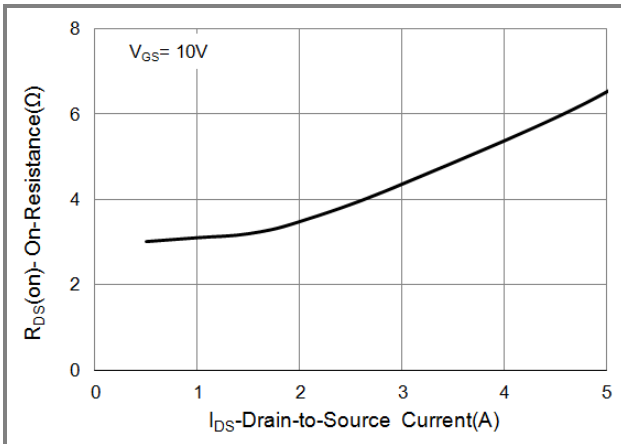

Fig.3 On-Resistance vs. Drain Current

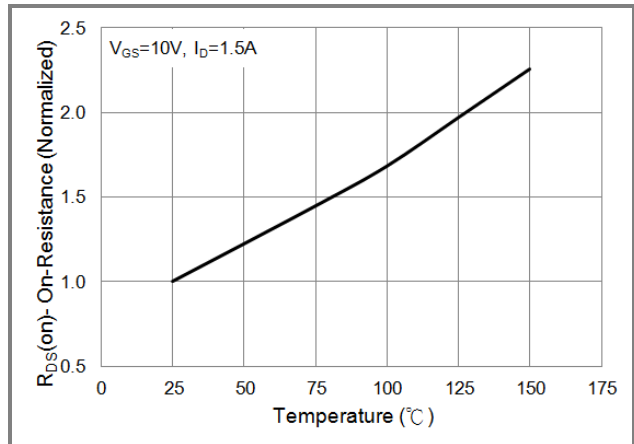

Fig.4 On-Resistance vs. Junction Temperature

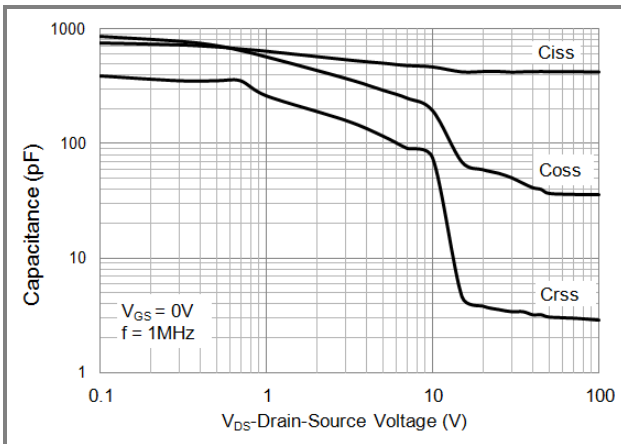

Fig.5 Capacitance vs. Drain-Source Voltage

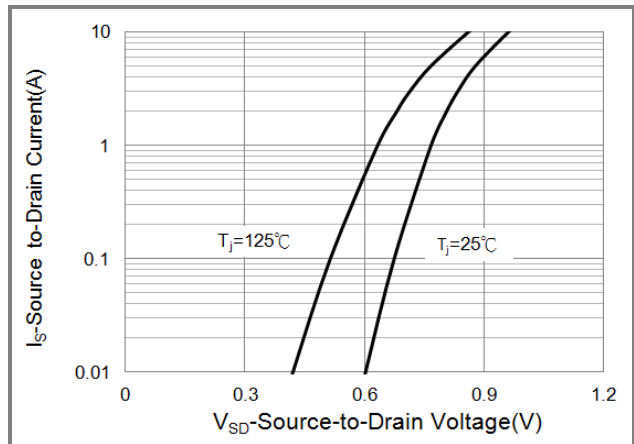

Fig.6 Source-Drain Diode Forward Voltage



PJU4NA65H / PJD4NA65H / PJP4NA65H / PJF4NA65H

TYPICAL CHARACTERISTIC CURVES

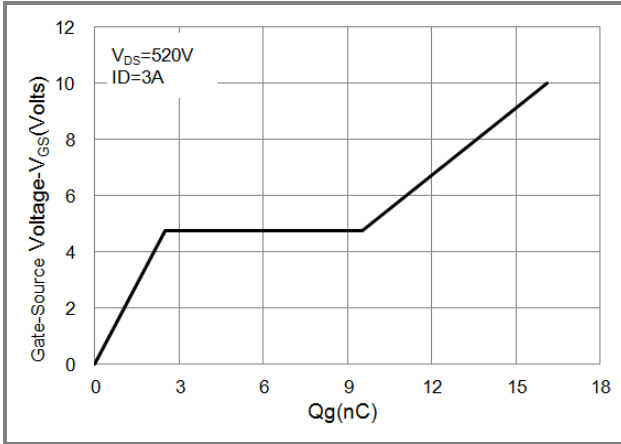

Fig.7 Gate Charge

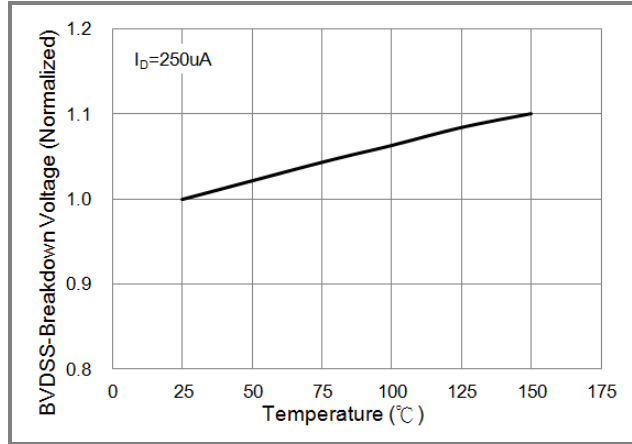

Fig.8 BV_{DSS} vs. Junction Temperature

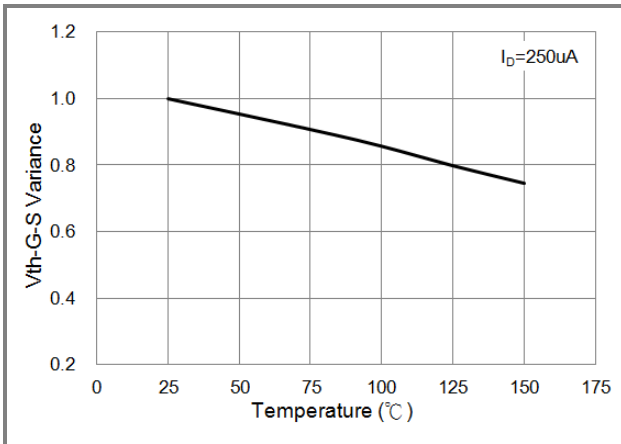

Fig.9 Threshold Voltage Variation with Temperature

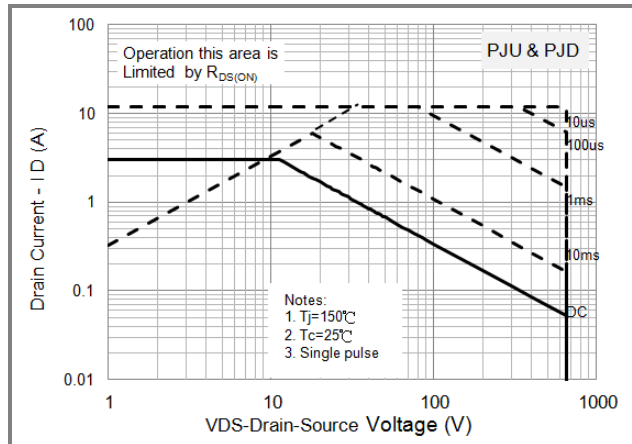

Fig.10 Maximum Safe Operating Area

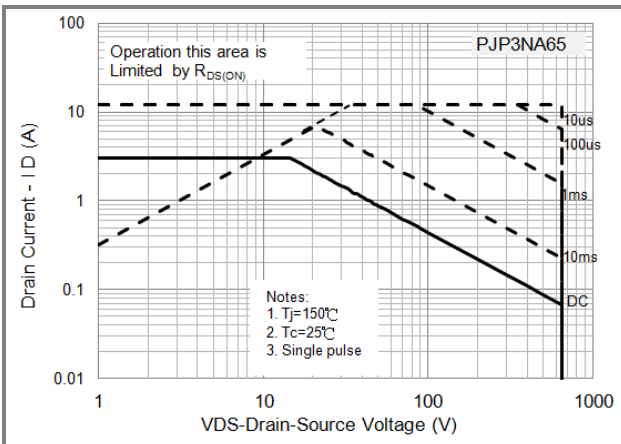

Fig.11 Maximum Safe Operating Area

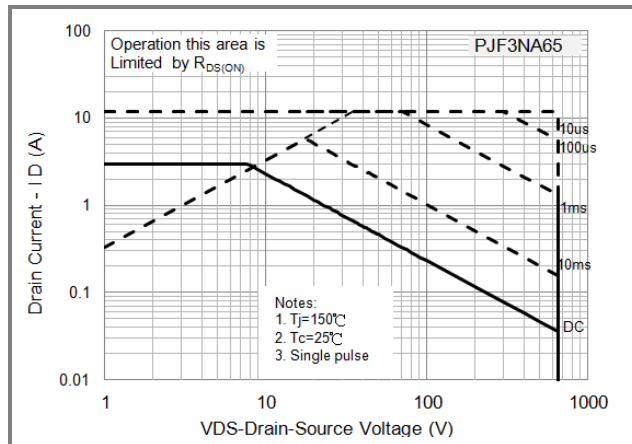

Fig.12 Maximum Safe Operating Area



PJU4NA65H / PJD4NA65H / PJP4NA65H / PJF4NA65H

TYPICAL CHARACTERISTIC CURVES

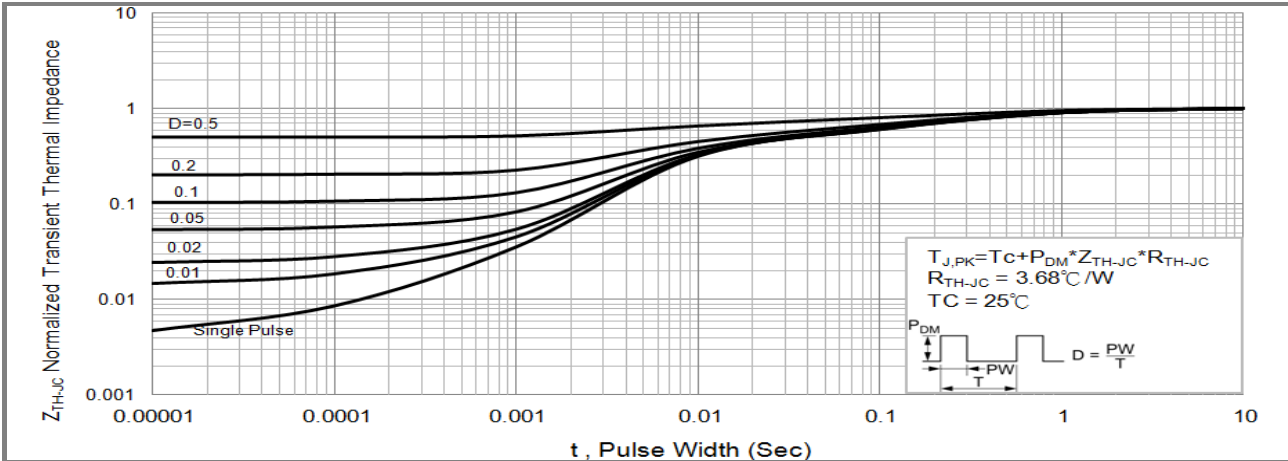

Fig.13 PJU/PJD Normalized Transient Thermal Impedance vs. Pulse Width

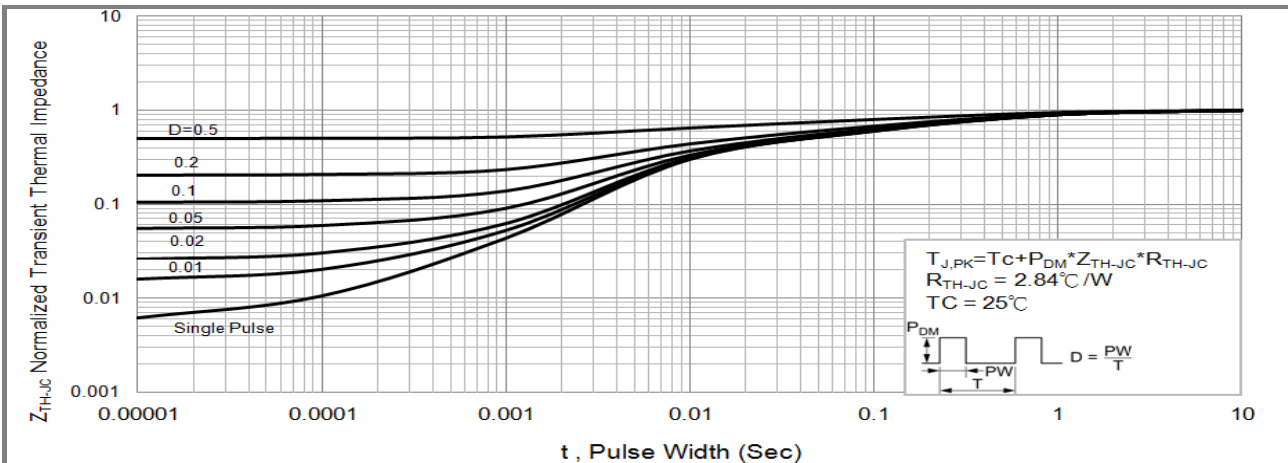

Fig.14 PJP Normalized Transient Thermal Impedance vs. Pulse Width

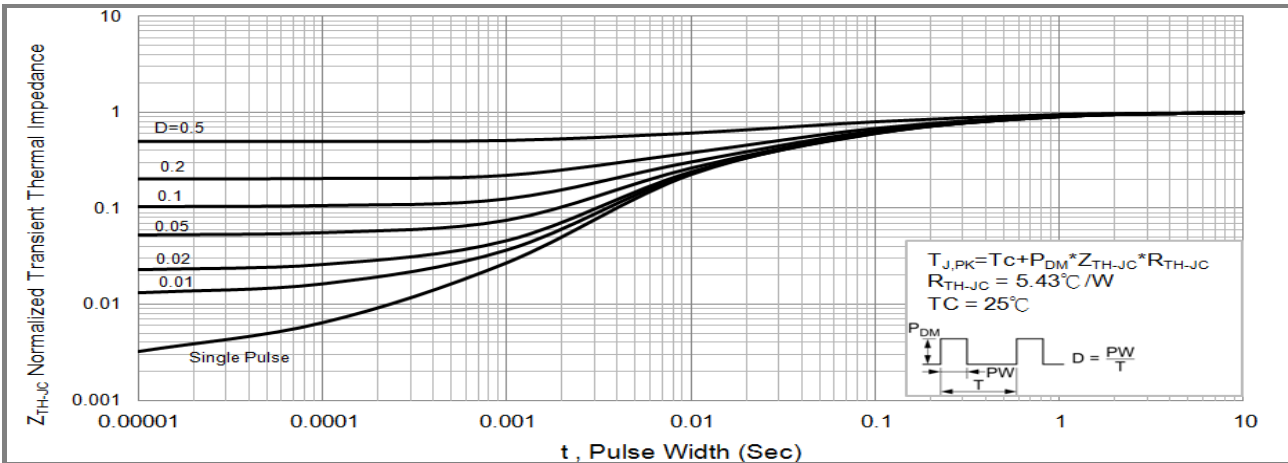
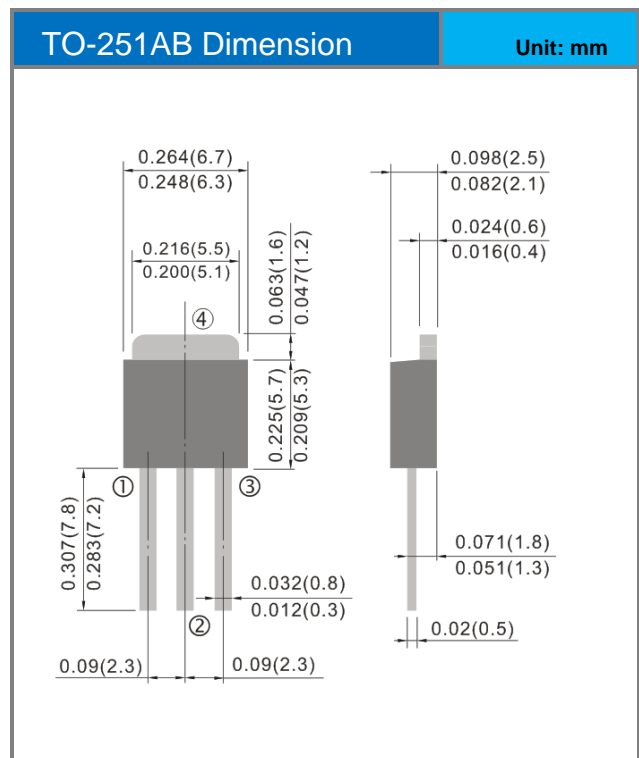
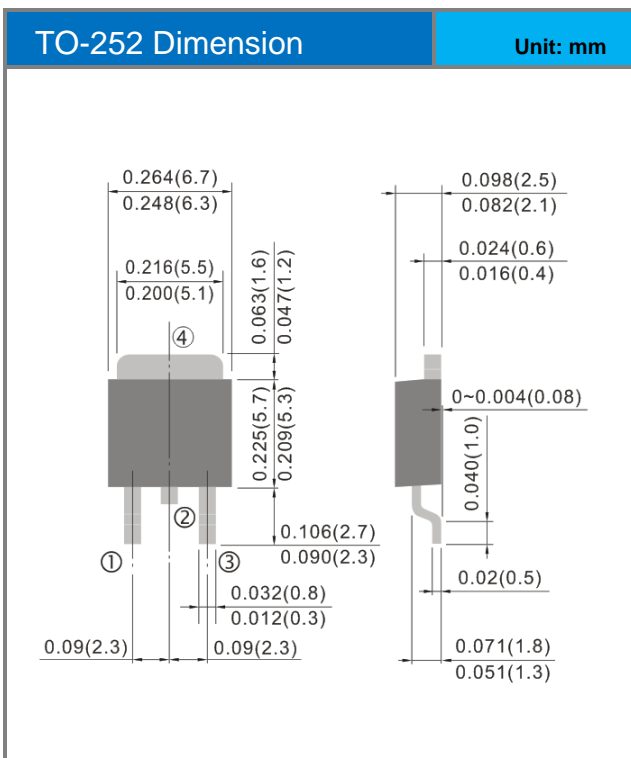
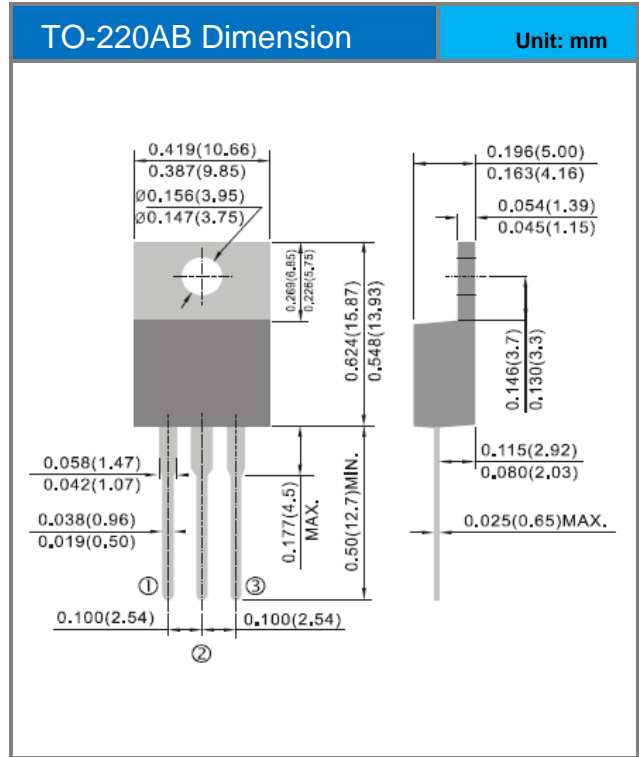
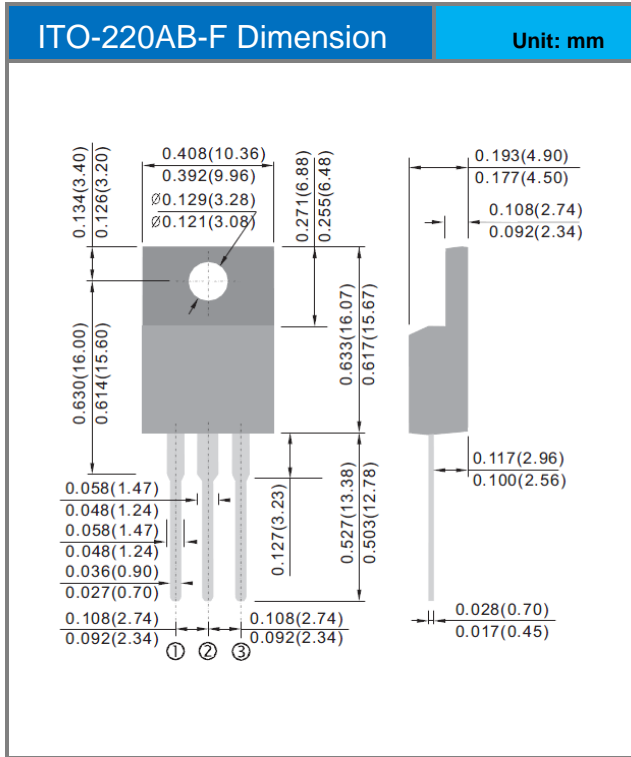

Fig.15 PJF Normalized Transient Thermal Impedance vs. Pulse Width



PJU4NA65H / PJD4NA65H / PJP4NA65H / PJF4NA65H

Packaging Information





PJU4NA65H / PJD4NA65H / PJP4NA65H / PJF4NA65H

PART NO PACKING CODE VERSION

Part No Packing Code	Package Type	Packing type	Marking	Version
PJU4NA65H_T0_00001	TO-251AB	80pcs / Tube	U4NA65H	Halogen free
PJD4NA65H_L2_00001	TO-252	3,000pcs / 13" reel	D4NA65H	Halogen free
PJP4NA65H_T0_00001	TO-220AB	50pcs / Tube	P4NA65H	Halogen free
PJF4NA65H_T0_00001	ITO-220AB-F	50pcs / Tube	F4NA65H	Halogen free



PJU4NA65H / PJD4NA65H / PJP4NA65H / PJF4NA65H

Disclaimer

- Reproducing and modifying information of the document is prohibited without permission from Panjit International Inc..
- Panjit International Inc. reserves the rights to make changes of the content herein the document anytime without notification. Please refer to our website for the latest document.
- Panjit International Inc. disclaims any and all liability arising out of the application or use of any product including damages incidentally and consequentially occurred.
- Panjit International Inc. does not assume any and all implied warranties, including warranties of fitness for particular purpose, non-infringement and merchantability.
- Applications shown on the herein document are examples of standard use and operation. Customers are responsible in comprehending the suitable use in particular applications. Panjit International Inc. makes no representation or warranty that such applications will be suitable for the specified use without further testing or modification.
- The products shown herein are not designed and authorized for equipments requiring high level of reliability or relating to human life and for any applications concerning life-saving or life-sustaining, such as medical instruments, transportation equipment, aerospace machinery et cetera. Customers using or selling these products for use in such applications do so at their own risk and agree to fully indemnify Panjit International Inc. for any damages resulting from such improper use or sale.
- Since Panjit uses lot number as the tracking base, please provide the lot number for tracking when complaining.