

## 6-Bit Windowed Volatile DAC with Command Code

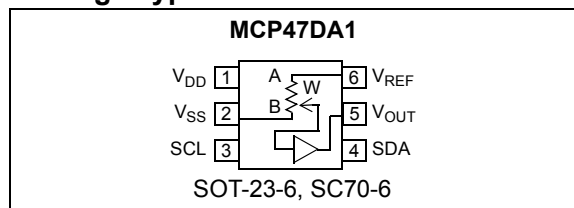
### Features:

- 6-Bit DAC:
  - 65 Taps: 64 Resistors with Taps to Full Scale and Zero Scale (Wiper Code 00h to 40h)
  - 7-bit Serial Data (00h to 7Fh, 00h - 20h = Zero Scale and 60h-7Fh = Full Scale)
- $V_{REF}$  Pull-down Resistance: 30 k $\Omega$  (typical)
- $V_{OUT}$  Voltage Range:
  - $1/3 * V_{REF}$  to  $2/3 * V_{REF}$
- I<sup>2</sup>C™ Protocol:
  - Supports SMBus 2.0 Write Byte/Word Protocol Formats
  - Supports SMBus 2.0 Read Byte/Word Protocol Formats
  - Slave Addresses: 5Ch and 7Ch
- Brown-out Reset Protection (1.5V, typical)
- Power-on Default Wiper Setting (Mid-scale)
- Low-Power Operation: 100  $\mu$ A Static Current (typ.)
- Wide Operating Voltage Range:
  - 2.7V to 5.5V – Device Characteristics Specified
  - 1.8V to 2.7V – Device Operation
- Low Tempco: 15 ppm (typical)
- 100 kHz (typical) Bandwidth (-3 dB) Operation
- Extended Temperature Range (-40°C to +125°C)
- Small Packages, SOT-23-6, SC70-6
- Lead Free (Pb-free) Package

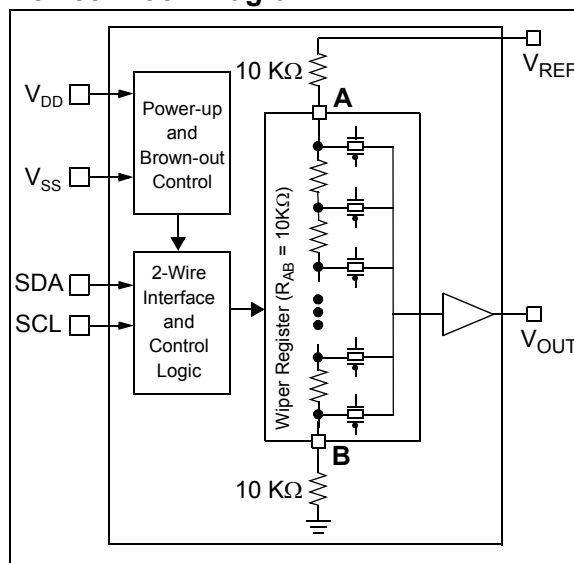
### Applications:

- PC Servers (I<sup>2</sup>C Protocol with Command Code)
- Set Point or Offset Trimming
- Cost-sensitive Mechanical Trim Pot Replacement

### Package Types



### Device Block Diagram



### Description:

The MCP47DA1 devices are volatile, 6-Bit digital potentiometers with a buffered output. The wiper setting is controlled through an I<sup>2</sup>C serial interface. The MCP47DA1. I<sup>2</sup>C slave addresses of "010 1110" and "011 1110" are supported. The MCP47DA1 has a windowed output ( $1/3$  to  $2/3$  of  $V_{REF}$ ).

### Device Features

| Device   | Interface         | # of Taps | # of Resistors | $V_{REF}$ Resistance | Data Value Range | POR/BOR Value | I <sup>2</sup> C™ Slave Address | $V_{DD}$ Operating Range (1) | $V_{OUT}$ Range                | Package(s)       |
|----------|-------------------|-----------|----------------|----------------------|------------------|---------------|---------------------------------|------------------------------|--------------------------------|------------------|
| MCP47DA1 | I <sup>2</sup> C™ | 65        | 64             | 30.0                 | 00h - 7Fh        | 40h           | 5Ch, 7Ch                        | 1.8V to 5.5V                 | $1/3 V_{REF}$ to $2/3 V_{REF}$ | SOT-23-6, SC70-6 |

**Note 1:** Analog characteristics only tested from 2.7V to 5.5V.

# MCP47DA1

---

NOTES:

## 1.0 ELECTRICAL CHARACTERISTICS

### Absolute Maximum Ratings †

|  |   |
|--|---|
| Voltage on $V_{DD}$ with respect to $V_{SS}$ .....                                   | 0.6V to +7.0V                               |
| Voltage on SCL, and SDA with respect to $V_{SS}$ .....                               | -0.6V to $V_{DD} + 0.3V$                    |
| Voltage on all other pins ( $V_{OUT}$ and $V_{REF}$ ) with respect to $V_{SS}$ ..... | -0.3V to $V_{DD} + 0.3V$                    |
| Input clamp current, $I_{IK}$ ( $V_I < 0$ , $V_I > V_{DD}$ ) .....                   | $\pm 20$ mA                                 |
| Output clamp current, $I_{OK}$ ( $V_O < 0$ or $V_O > V_{DD}$ ) .....                 | $\pm 20$ mA                                 |
| Maximum output current sunk by any Output pin .....                                  | 25 mA                                       |
| Maximum output current sourced by any Output pin .....                               | 25 mA                                       |
| Maximum current out of $V_{SS}$ pin .....  | 100 mA                                      |
| Maximum current into $V_{DD}$ pin .....  | 100 mA                                      |
| Maximum current into $V_{REF}$ pin .....   | 250 $\mu$ A                                 |
| Maximum current sourced by $V_{OUT}$ pin .....                                       | 40 mA                                       |
| Maximum current sunk by $V_{REF}$ pin .....  | 40 mA                                       |
| Package power dissipation ( $T_A = +50^\circ\text{C}$ , $T_J = +150^\circ\text{C}$ ) |   |
| SOT-23-6 .....   | 525 mW                                      |
| SC70-6 .....   | 480 mW                                      |
| Storage temperature .....  | $-65^\circ\text{C}$ to $+150^\circ\text{C}$ |
| Ambient temperature with power applied .....   | $-40^\circ\text{C}$ to $+125^\circ\text{C}$ |
| ESD protection on all pins .....   | $\geq 6$ kV (HBM)                           |
| .....  | $\geq 400$ V (MM)                           |
| .....  | $\geq 1.5$ kV (CDM) (for SOT-23)            |
| .....  | $\geq 1.5$ kV (CDM) (for SC-70)             |
| Latch-up (JEDEC JESD78A) at $+125^\circ\text{C}$ .....                               | $\pm 100$ mA                                |
| Soldering temperature of leads (10 seconds) .....                                    | $+300^\circ\text{C}$                        |
| Maximum Junction Temperature ( $T_J$ ) .....   | $+150^\circ\text{C}$                        |

† **Notice:** Stresses above those listed under “Maximum Ratings” may cause permanent damage to the device. This is a stress rating only and functional operation of the device at those or any other conditions above those indicated in the operational listings of this specification is not implied. Exposure to maximum rating conditions for extended periods may affect device reliability.

# MCP47DA1

## AC/DC CHARACTERISTICS

| DC Characteristics  |            | Standard Operating Conditions (unless otherwise specified)<br>Operating Temperature $-40^{\circ}\text{C} \leq T_A \leq +125^{\circ}\text{C}$ (extended)<br>All parameters apply across the specified operating ranges unless noted.<br>$V_{DD} = +2.7\text{V}$ to $+5.5\text{V}$ . $C_L = 1\text{ nF}$ , $R_L = 5\text{ k}\Omega$ .<br>Typical specifications represent values for $V_{DD} = 5.5\text{V}$ , $T_A = +25^{\circ}\text{C}$ . |      |          |               |  |
|---|------------|---|------|----------|---------------|--|
| Parameters  | Sym.       | Min.  | Typ. | Max.     | Units         | Conditions   |
| Supply Voltage  | $V_{DD}$   | 2.7   | —    | 5.5      | V             | Analog Characteristics specified   |
|   |            | 1.8   | —    | 5.5      | V             | Digital Characteristics specified  |
| $V_{DD}$ Start Voltage to ensure wiper to default Reset state                               | $V_{BOR}$  | —   | —    | 1.65     | V             | RAM retention voltage ( $V_{RAM}$ ) < $V_{BOR}$  |
| $V_{DD}$ Rise Rate to ensure Power-on Reset   | $V_{DDRR}$ | Note 5  |      |          | V/ms          |  |
| Delay after device exits the Reset state ( $V_{DD} > V_{BOR}$ ) to Digital Interface Active | $T_{BORD}$ | —   | —    | 1        | $\mu\text{S}$ |  |
| Delay after device exits the Reset state ( $V_{DD} > V_{BOR}$ ) to $V_{OUT}$ valid          | $T_{OUTV}$ |   |      | 20       | $\mu\text{S}$ | Within $\pm 0.5$ LSB of $V_{REF}/2$ (for default POR/BOR wiper value).   |
| Supply Current (Note 6)   | $I_{DD}$   | —   | 130  | 200      | $\mu\text{A}$ | Serial Interface Active, Write all 0's to volatile wiper, No Load on $V_{OUT}$<br>$V_{DD} = 5.5\text{V}$ , $V_{REF} = 1.5\text{V}$ , $F_{SCL} = 400\text{ kHz}$  |
|   |            | —   | 100  | 160      | $\mu\text{A}$ | Serial Interface Inactive (Static), (Stop condition, $SCL = SDA = V_{IH}$ ), No Load on $V_{OUT}$<br>Wiper = 0, $V_{DD} = 5.5\text{V}$ , $V_{REF} = 1.5\text{V}$ |
| $V_{REF}$ Input Range   | $V_{REF}$  | 1   | —    | $V_{DD}$ | V             | For $V_{DD} \geq 3.0\text{V}$<br>$V_{REF} \leq V_{DD}$<br>For $V_{DD} < 3.0\text{V}$<br>$V_{REF} \leq (V_{DD} - 1.0\text{V})/(2/3)$ (Note 7)                     |

- Note 1:** Resistance is defined as the resistance between the  $V_{REF}$  pin and the  $V_{SS}$  pin.
- 2:** INL and DNL are measured at  $V_{OUT}$  from Code = 20h (Zero Scale) through Code = 60h (Full Scale).
- 3:** This specification by design.
- 4:** Non-linearity is affected by wiper resistance ( $R_W$ ), which changes significantly over voltage and temperature.
- 5:** POR/BOR is not rate dependent.
- 6:** Supply current is independent of  $V_{REF}$  current.
- 7:** See [Section 7.1.3](#).

## AC/DC CHARACTERISTICS (CONTINUED)

| DC Characteristics  |                | Standard Operating Conditions (unless otherwise specified)<br>Operating Temperature $-40^{\circ}\text{C} \leq T_A \leq +125^{\circ}\text{C}$ (extended)<br>All parameters apply across the specified operating ranges unless noted.<br>$V_{DD} = +2.7\text{V}$ to $+5.5\text{V}$ . $C_L = 1\text{ nF}$ , $R_L = 5\text{ k}\Omega$ .<br>Typical specifications represent values for $V_{DD} = 5.5\text{V}$ , $T_A = +25^{\circ}\text{C}$ . |                 |      |                       |   |
|---|----------------|---|-----------------|------|-----------------------|---|
| Parameters  | Sym.           | Min.  | Typ.            | Max. | Units                 | Conditions  |
| <b>Output Amplifier</b>                                   |                |   |                 |      |                       |   |
| Minimum Output Voltage                                    | $V_{OUT(MIN)}$ | —   | $V_{REF} / 3$   | —    | V                     | Device Output minimum drive                                     |
| Maximum Output Voltage                                    | $V_{OUT(MAX)}$ | —   | $2 * V_{REF}/3$ | —    | V                     | Device Output maximum drive                                     |
| Phase Margin  | PM             | —   | 66              | —    | Degree ( $^{\circ}$ ) | $C_L = 400\text{ pF}$ , $R_L = \infty$                          |
| Slew Rate   | SR             | —   | 0.55            | —    | V/ $\mu\text{s}$      |   |
| Short Circuit Current                                     | $I_{SC}$       | 5   | 15              | 24   | mA                    |   |
| Settling Time   | $t_{SETTLING}$ | —   | 6               | —    | $\mu\text{s}$         |   |
| <b>External Reference (<math>V_{REF}</math>) (Note 3)</b> |                |   |                 |      |                       |   |
| Input Capacitance   | $C_{VREF}$     | —   | 7               | —    | pF                    |   |
| Total Harmonic Distortion                                 | THD            | —   | -73             | —    | dB                    | $V_{REF} = 1.65\text{V} \pm 0.1\text{V}$ ,<br>Frequency = 1 kHz |
| <b>Dynamic Performance (Note 3)</b>                       |                |   |                 |      |                       |   |
| Major Code Transition Glitch                              |                | —   | 45              | —    | nV-s                  | 1 LSB change around major carry (40h to 3Fh)                    |
| Digital Feedthrough                                       |                | —   | <10             | —    | nV-s                  |   |

- Note 1:** Resistance is defined as the resistance between the  $V_{REF}$  pin and the  $V_{SS}$  pin.
- 2:** INL and DNL are measured at  $V_{OUT}$  from Code = 20h (Zero Scale) through Code = 60h (Full Scale).
- 3:** This specification by design.
- 4:** Non-linearity is affected by wiper resistance ( $R_W$ ), which changes significantly over voltage and temperature.
- 5:** POR/BOR is not rate dependent.
- 6:** Supply current is independent of  $V_{REF}$  current.
- 7:** See [Section 7.1.3](#).

# MCP47DA1

## AC/DC CHARACTERISTICS (CONTINUED)

| DC Characteristics                                    |                              | Standard Operating Conditions (unless otherwise specified)<br>Operating Temperature $-40^{\circ}\text{C} \leq T_A \leq +125^{\circ}\text{C}$ (extended)<br>All parameters apply across the specified operating ranges unless noted.<br>$V_{DD} = +2.7\text{V}$ to $+5.5\text{V}$ . $C_L = 1\text{ nF}$ , $R_L = 5\text{ k}\Omega$ .<br>Typical specifications represent values for $V_{DD} = 5.5\text{V}$ , $T_A = +25^{\circ}\text{C}$ . |                  |       |                               |  |
|---|------------------------------|---|------------------|-------|-------------------------------|--|
| Parameters  | Sym.                         | Min.  | Typ.             | Max.  | Units                         | Conditions   |
| Resistance ( $\pm 20\%$ )                             | $R_{VREF}$                   | 24.0  | 30               | 36.0  | $\text{k}\Omega$              | Note 1   |
| Resolution  | N                            | 65  |                  |       | Taps                          | No Missing Codes   |
| Step Resistance                                       | $R_S$                        | —   | $R_{VREF} / 192$ | —     | $\Omega$                      | Note 3   |
| Nominal Resistance Tempco                             | $\Delta R_{VREF} / \Delta T$ | —   | 50               | —     | $\text{ppm}/^{\circ}\text{C}$ | $T_A = -20^{\circ}\text{C}$ to $+70^{\circ}\text{C}$                               |
|   |                              | —   | 100              | —     | $\text{ppm}/^{\circ}\text{C}$ | $T_A = -40^{\circ}\text{C}$ to $+85^{\circ}\text{C}$                               |
|   |                              | —   | 150              | —     | $\text{ppm}/^{\circ}\text{C}$ | $T_A = -40^{\circ}\text{C}$ to $+125^{\circ}\text{C}$                              |
| Ratiometric Tempco                                    | $\Delta V_{OUT} / \Delta T$  | —   | 15               | —     | $\text{ppm}/^{\circ}\text{C}$ | Code = Mid-scale (40h)   |
| $V_{OUT}$ Accuracy                                    |                              | 740   | 750              | 760   | mV                            | $3.0\text{V} \leq V_{DD} \leq 3.6\text{V}$<br>$V_{REF} = 1.5\text{V}$ , code = 40h |
| $V_{OUT}$ Load  | $L_{VOUTR}$                  | 5   | —                | —     | $\text{k}\Omega$              | Resistive Load   |
|   | $L_{VOUTC}$                  | —   | —                | 1     | nF                            | Capacitive Load  |
| Maximum current through Terminal ( $V_{REF}$ ) Note 3 | $I_{VREF}$                   | —   | —                | 230   | $\mu\text{A}$                 | $V_{REF} = 5.5\text{V}$  |
| Leakage current into $V_{REF}$                        | $I_L$                        | —   | 100              | —     | nA                            | $V_{REF} = V_{SS}$   |
| Full-Scale Error (code = 60h)                         | $V_{FSE}$                    | -1.5  | $\pm 0.35$       | +1.5  | LSb                           | $2.7\text{V} \leq V_{DD} \leq 5.5\text{V}$ , $V_{REF} = 1.65\text{V}$              |
| Zero-Scale Error (code = 20h)                         | $V_{ZSE}$                    | -1.5  | $\pm 0.35$       | +1.5  | LSb                           | $2.7\text{V} \leq V_{DD} \leq 5.5\text{V}$ , $V_{REF} = 1.65\text{V}$              |
| $V_{OUT}$ Integral Non-linearity                      | INL                          | -0.7  | $\pm 0.25$       | +0.7  | LSb                           | $2.7\text{V} \leq V_{DD} \leq 5.5\text{V}$ (Note 2)<br>$V_{REF} = 1.65\text{V}$    |
| $V_{OUT}$ Differential Non-linearity                  | DNL                          | -0.35   | $\pm 0.125$      | +0.35 | LSb                           | $2.7\text{V} \leq V_{DD} \leq 5.5\text{V}$ (Note 2)<br>$V_{REF} = 1.65\text{V}$    |
| Bandwidth -3 dB                                       | BW                           | —   | 100              | —     | kHz                           | $V_{REF} = 1.5\text{V} \pm 0.1\text{V}$ , Code = 40h                               |
| Capacitance ( $V_{REF}$ )                             | $C_{REF}$                    | —   | 75               | —     | pF                            | $f = 1\text{ MHz}$ , Code = Full Scale   |

- Note 1:** Resistance is defined as the resistance between the  $V_{REF}$  pin and the  $V_{SS}$  pin.
- 2:** INL and DNL are measured at  $V_{OUT}$  from Code = 20h (Zero Scale) through Code = 60h (Full Scale).
- 3:** This specification by design.
- 4:** Non-linearity is affected by wiper resistance ( $R_W$ ), which changes significantly over voltage and temperature.
- 5:** POR/BOR is not rate dependent.
- 6:** Supply current is independent of  $V_{REF}$  current.
- 7:** See [Section 7.1.3](#).

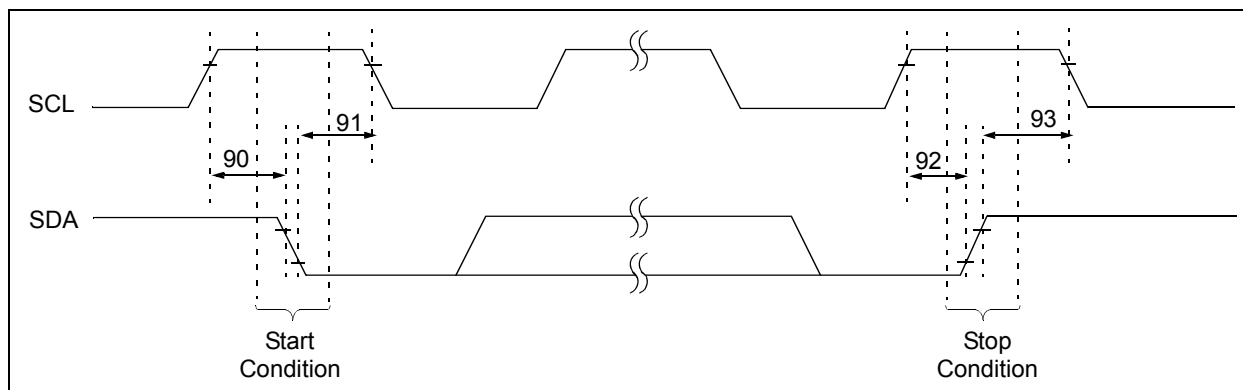
## AC/DC CHARACTERISTICS (CONTINUED)

| DC Characteristics                            |                   | Standard Operating Conditions (unless otherwise specified)   |             |             |               |   |
|---|-------------------|--|-------------|-------------|---------------|---|
|   |                   | Operating Temperature $-40^{\circ}\text{C} \leq T_A \leq +125^{\circ}\text{C}$ (extended)          |             |             |               |   |
|   |                   | All parameters apply across the specified operating ranges unless noted.                           |             |             |               |   |
|   |                   | $V_{DD} = +2.7\text{V}$ to $+5.5\text{V}$ . $C_L = 1\text{ nF}$ , $R_L = 5\text{ k}\Omega$ .       |             |             |               |   |
|   |                   | Typical specifications represent values for $V_{DD} = 5.5\text{V}$ , $T_A = +25^{\circ}\text{C}$ . |             |             |               |   |
| Parameters                                    | Sym.              | Min.   | Typ.        | Max.        | Units         | Conditions  |
| <b>Digital Inputs/Outputs (SDA, SCK)</b>      |                   |  |             |             |               |   |
| Schmitt Trigger High Input Threshold          | $V_{IH}$          | $0.7 V_{DD}$   | —           | —           | V             | $2.7\text{V} \leq V_{DD} \leq 5.5\text{V}$                                      |
| Schmitt Trigger Low Input Threshold           | $V_{IL}$          | -0.5   | —           | $0.3V_{DD}$ | V             |   |
| Hysteresis of Schmitt Trigger Inputs (Note 3) | $V_{HYS}$         | —  | $0.1V_{DD}$ | —           | V             | All inputs except SDA and SCL   |
|   |                   | N.A.   | —           | —           | V             |   |
|   |                   | N.A.   | —           | —           | V             |   |
|   |                   | $0.1 V_{DD}$   | —           | —           | V             |   |
|   |                   | $0.05 V_D$   | —           | —           | V             |   |
| Output Low Voltage (SDA)                      | $V_{OL}$          | $V_{SS}$   | —           | $0.2V_{DD}$ | V             | $V_{DD} < 2.0\text{V}$ , $I_{OL} = 1\text{ mA}$                                 |
|   |                   | $V_{SS}$   | —           | 0.4         | V             | $V_{DD} \geq 2.0\text{V}$ , $I_{OL} = 3\text{ mA}$                              |
| Input Leakage Current                         | $I_{IL}$          | -1   | —           | 1           | $\mu\text{A}$ | $V_{REF} = V_{DD}$ and $V_{REF} = V_{SS}$                                       |
| Pin Capacitance                               | $C_{IN}, C_{OUT}$ | —  | 10          | —           | pF            | $f_C = 400\text{ kHz}$  |
| <b>RAM (Wiper) Value</b>                      |                   |  |             |             |               |   |
| Value Range                                   | N                 | 0h   | —           | 7Fh         | hex           | Zero Scale = 00h thru 20h, Full Scale = 60h thru 7Fh                            |
| Wiper POR/BOR Value                           | $N_{POR/BOR}$     | 40h  |             |             | hex           |   |
| <b>Power Requirements</b>                     |                   |  |             |             |               |   |
| Power Supply Sensitivity                      | PSS               | —  | 0.0015      | 0.0035      | %/%           | $V_{DD} = 2.7\text{V}$ to $5.5\text{V}$ , $V_{REF} = 1.65\text{V}$ , Code = 40h |

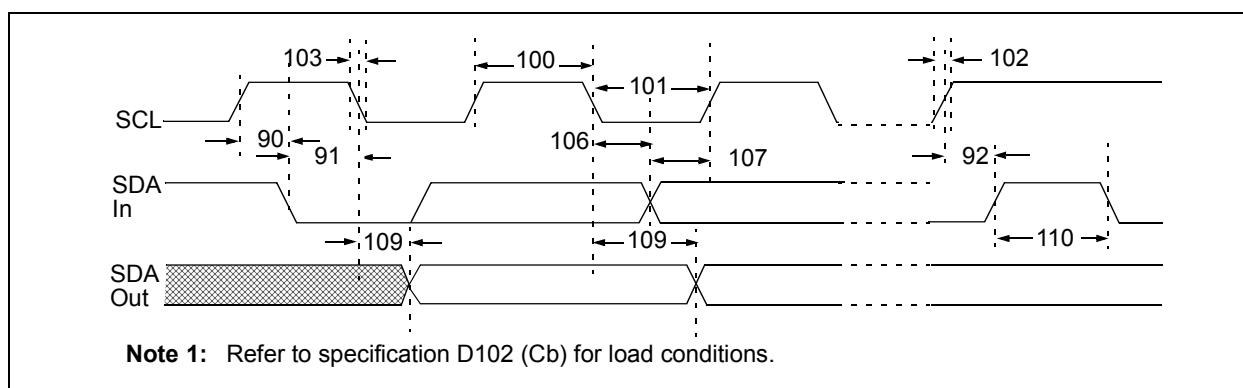
- Note 1:** Resistance is defined as the resistance between the  $V_{REF}$  pin and the  $V_{SS}$  pin.
- Note 2:** INL and DNL are measured at  $V_{OUT}$  from Code = 20h (Zero Scale) through Code = 60h (Full Scale).
- Note 3:** This specification by design.
- Note 4:** Non-linearity is affected by wiper resistance ( $R_W$ ), which changes significantly over voltage and temperature.
- Note 5:** POR/BOR is not rate dependent.
- Note 6:** Supply current is independent of  $V_{REF}$  current.
- Note 7:** See [Section 7.1.3](#).

# MCP47DA1

## 1.1 I<sup>2</sup>C Mode Timing Waveforms and Requirements



**FIGURE 1-1:** I<sup>2</sup>C Bus Start/Stop Bits Timing Waveforms.



**Note 1:** Refer to specification D102 (Cb) for load conditions.

**FIGURE 1-2:** I<sup>2</sup>C Bus Data Timing.

**TABLE 1-1: I<sup>2</sup>C BUS START/STOP BITS REQUIREMENTS**

| I <sup>2</sup> C™ AC Characteristics |                     | Standard Operating Conditions (unless otherwise specified)   |      |      |       |   |
|--------------------------------------|---------------------|--|------|------|-------|---|
|                                      |                     | Operating Temperature -40°C ≤ TA ≤ +125°C (Extended)   |      |      |       |   |
|                                      |                     | Operating Voltage V <sub>DD</sub> range is described in <a href="#">Section 2.0 “Typical Performance Curves”</a> |      |      |       |   |
| Param. No.                           | Symbol              | Characteristic   | Min. | Max. | Units | Conditions  |
|                                      | F <sub>SCL</sub>    |  |      |      |       |   |
|                                      |                     | Standard mode  | 0    | 100  | kHz   | C <sub>b</sub> = 400 pF, 1.8V-5.5V                    |
|                                      |                     | Fast mode  | 0    | 400  | kHz   | C <sub>b</sub> = 400 pF, 2.7V-5.5V                    |
| D102                                 | Cb                  | Bus capacitive loading   |      |      |       |   |
|                                      |                     | 100 kHz mode   | —    | 400  | pF    |   |
|                                      |                     | 400 kHz mode   | —    | 400  | pF    |   |
| 90                                   | TSU:STA             | Start condition Setup time   |      |      |       | Only relevant for repeated Start condition            |
|                                      |                     | 100 kHz mode   | 4700 | —    | ns    |   |
|                                      |                     | 400 kHz mode   | 600  | —    | ns    |   |
| 91                                   | T <sub>HD:STA</sub> | Start condition Hold time  |      |      |       | After this period, the first clock pulse is generated |
|                                      |                     | 100 kHz mode   | 4000 | —    | ns    |   |
|                                      |                     | 400 kHz mode   | 600  | —    | ns    |   |
| 92                                   | TSU:STO             | Stop condition Setup time  |      |      |       |   |
|                                      |                     | 100 kHz mode   | 4000 | —    | ns    |   |
|                                      |                     | 400 kHz mode   | 600  | —    | ns    |   |
| 93                                   | T <sub>HD:STO</sub> | Stop condition Hold time   |      |      |       |   |
|                                      |                     | 100 kHz mode   | 4000 | —    | ns    |   |
|                                      |                     | 400 kHz mode   | 600  | —    | ns    |   |



**TABLE 1-2: I<sup>2</sup>C BUS DATA REQUIREMENTS (SLAVE MODE)**

| I <sup>2</sup> C™ AC Characteristics |                   |  | Standard Operating Conditions (unless otherwise specified)          |                           |       |            |   |
|--------------------------------------|-------------------|--|---|---------------------------|-------|------------|---|
|                                      |                   |  | Operating Temperature –40°C ≤ TA ≤ +125°C (Extended)                |                           |       |            |   |
|                                      |                   |  | Operating Voltage VDD range is described in “AC/DC characteristics” |                           |       |            |   |
| Param. No.                           | Sym.              | Characteristic                               | Min.  | Max.                      | Units | Conditions |   |
| 100                                  | T <sub>HIGH</sub> | Clock high time                              | 100 kHz mode  | 4000                      | —     | ns         | 1.8V-5.5V   |
|                                      |                   |  | 400 kHz mode  | 600                       | —     | ns         | 2.7V-5.5V   |
| 101                                  | T <sub>LOW</sub>  | Clock low time                               | 100 kHz mode  | 4700                      | —     | ns         | 1.8V-5.5V   |
|                                      |                   |  | 400 kHz mode  | 1300                      | —     | ns         | 2.7V-5.5V   |
| 102A <sup>(5)</sup>                  | T <sub>RSCL</sub> | SCL rise time                                | 100 kHz mode  | —                         | 1000  | ns         | C <sub>b</sub> is specified to be from 10 to 400 pF           |
|                                      |                   |  | 400 kHz mode  | 20 + 0.1Cb                | 300   | ns         |   |
| 102B <sup>(5)</sup>                  | T <sub>RSDA</sub> | SDA rise time                                | 100 kHz mode  | —                         | 1000  | ns         | C <sub>b</sub> is specified to be from 10 to 400 pF           |
|                                      |                   |  | 400 kHz mode  | 20 + 0.1Cb                | 300   | ns         |   |
| 103A <sup>(5)</sup>                  | T <sub>FSCL</sub> | SCL fall time                                | 100 kHz mode  | —                         | 300   | ns         | C <sub>b</sub> is specified to be from 10 to 400 pF           |
|                                      |                   |  | 400 kHz mode  | 20 + 0.1Cb                | 40    | ns         |   |
| 103B <sup>(5)</sup>                  | T <sub>FSDA</sub> | SDA fall time                                | 100 kHz mode  | —                         | 300   | ns         | C <sub>b</sub> is specified to be from 10 to 400 pF           |
|                                      |                   |  | 400 kHz mode  | 20 + 0.1Cb <sup>(5)</sup> | 300   | ns         |   |
| 106                                  | THD:DAT           | Data input hold time                         | 100 kHz mode  | 0                         | —     | ns         | 1.8V-5.5V (Note 6)  |
|                                      |                   |  | 400 kHz mode  | 0                         | —     | ns         | 2.7V-5.5V (Note 6)  |
| 107                                  | TSU:DAT           | Data input setup time                        | 100 kHz mode  | 250                       | —     | ns         | Note 5  |
|                                      |                   |  | 400 kHz mode  | 100                       | —     | ns         |   |
| 109                                  | T <sub>AA</sub>   | Output valid from clock                      | 100 kHz mode  | —                         | 3450  | ns         | Note 5  |
|                                      |                   |  | 400 kHz mode  | —                         | 900   | ns         |   |
| 110                                  | T <sub>BUF</sub>  | Bus free time                                | 100 kHz mode  | 4700                      | —     | ns         | Time the bus must be free before a new transmission can start |
|                                      |                   |  | 400 kHz mode  | 1300                      | —     | ns         |   |
|                                      | T <sub>SP</sub>   | Input filter spike suppression (SDA and SCL) | 100 kHz mode  | —                         | 50    | ns         | Philips spec. states N.A.                                     |
|                                      |                   |  | 400 kHz mode  | —                         | 50    | ns         |   |

- Note 1:** As a transmitter, the device must provide this internal minimum delay time to bridge the undefined region (min. 300 ns) of the falling edge of SCL to avoid unintended generation of Start or Stop conditions.
- 2:** A Fast mode (400 kHz) I<sup>2</sup>C™ bus device can be used in a Standard mode (100 kHz) I<sup>2</sup>C bus system, but the requirement tsu; DAT ≥ 250 ns must then be met. This will automatically be the case if the device does not stretch the Low period of the SCL signal. If such a device does stretch the Low period of the SCL signal, it must output the next data bit to the SDA line.  
TR max. +tsu; DAT = 1000 + 250 = 1250 ns (according to the Standard mode I<sup>2</sup>C bus specification) before the SCL line is released.
- 3:** The MCP47DA1 device must provide a data hold time to bridge the undefined part between VIH and VIL of the falling edge of the SCL signal. This specification is not a part of the I<sup>2</sup>C specification, but must be tested in order to ensure that the output data will meet the setup and hold specifications for the receiving device.
- 4:** Use C<sub>b</sub> in pF for the calculations.
- 5:** Not tested.
- 6:** A Master Transmitter must provide a delay to ensure that difference between SDA and SCL fall times do not unintentionally create a Start or Stop condition.

# MCP47DA1

## TEMPERATURE CHARACTERISTICS

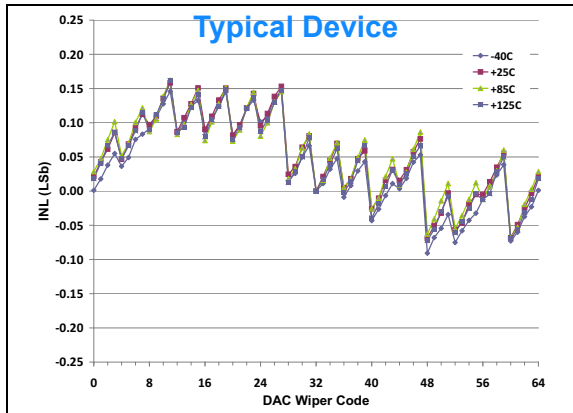
| Electrical Specifications: Unless otherwise indicated, $V_{DD} = +2.7V$ to $+5.5V$ , $V_{SS} = GND$ . |               |      |      |      |       |            |
|---|---------------|------|------|------|-------|------------|
| Parameters  | Sym.          | Min. | Typ. | Max. | Units | Conditions |
| Temperature Ranges  |               |      |      |      |       |            |
| Specified Temperature Range   | $T_A$         | -40  | —    | +125 | °C    |            |
| Operating Temperature Range   | $T_A$         | -40  | —    | +125 | °C    |            |
| Storage Temperature Range   | $T_A$         | -65  | —    | +150 | °C    |            |
| Thermal Package Resistances   |               |      |      |      |       |            |
| Thermal Resistance, 6L-SOT-23   | $\theta_{JA}$ | —    | 190  | —    | °C/W  | Note 1     |
| Thermal Resistance, 6L-SC70   | $\theta_{JA}$ | —    | 207  | —    | °C/W  | Note 1     |

**Note 1:** Package Power Dissipation ( $P_{DIS}$ ) is calculated as follows:  
 $P_{DIS} = (T_J - T_A) / \theta_{JA}$ ,  
where:  $T_J$  = Junction Temperature,  $T_A$  = Ambient Temperature.

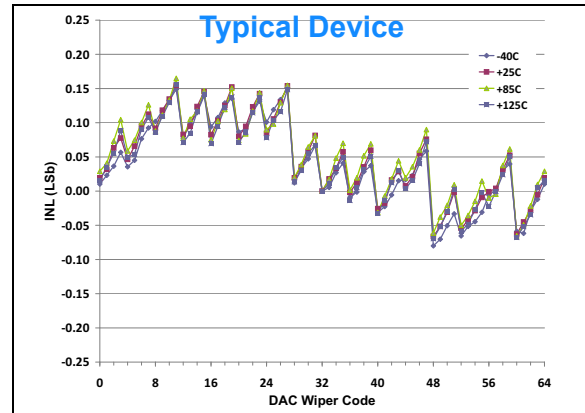
## 2.0 TYPICAL PERFORMANCE CURVES

**Note 1:** The graphs and tables provided following this note are a statistical summary based on a limited number of samples and are provided for informational purposes only. The performance characteristics listed herein are not tested or guaranteed. In some graphs or tables, the data presented may be outside the specified operating range (e.g., outside specified power supply range) and therefore outside the warranted range.

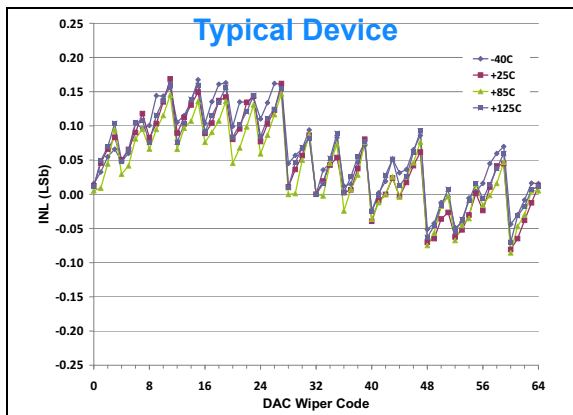
**Note:** Unless otherwise indicated,  $T_A = +25^\circ\text{C}$ ,  $V_{DD} = V_{REF} = 5\text{V}$ ,  $V_{SS} = 0\text{V}$ ,  $R_L = 5\text{ k}\Omega$ ,  $C_L = 1\text{ nF}$ .



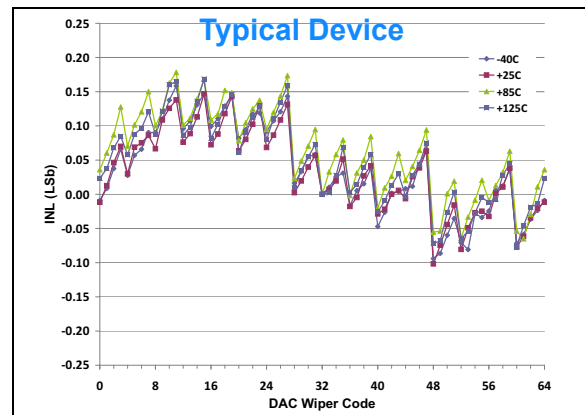
**FIGURE 2-1:** INL vs. Code and Temperature.  $V_{DD} = 5.5\text{V}$ ,  $V_{REF} = 5.5\text{V}$ .



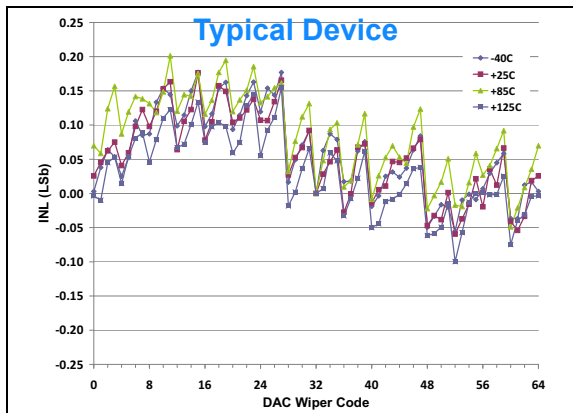
**FIGURE 2-4:** INL vs. Code and Temperature.  $V_{DD} = 3.6\text{V}$ ,  $V_{REF} = 3.6\text{V}$ .



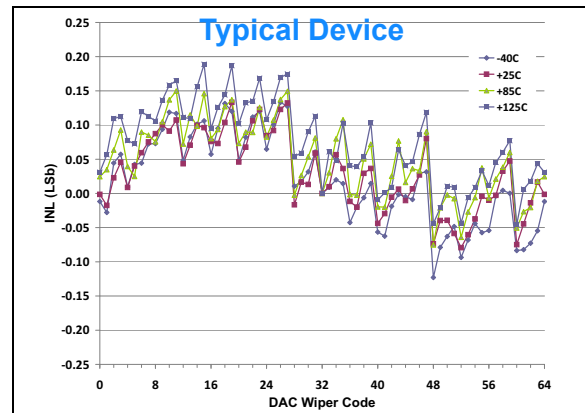
**FIGURE 2-2:** INL vs. Code and Temperature.  $V_{DD} = 5.5\text{V}$ ,  $V_{REF} = 1.65\text{V}$ .



**FIGURE 2-5:** INL vs. Code and Temperature.  $V_{DD} = 3.6\text{V}$ ,  $V_{REF} = 1.65\text{V}$ .



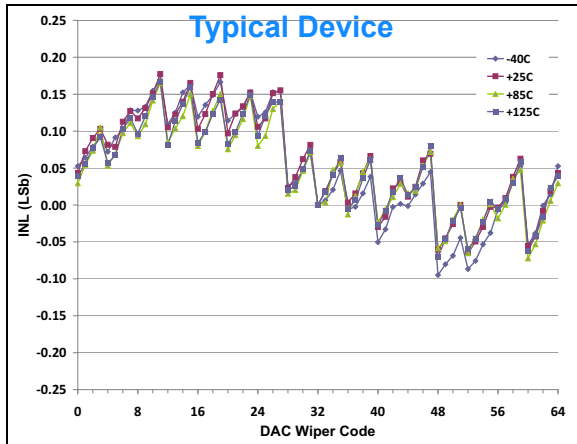
**FIGURE 2-3:** INL vs. Code and Temperature.  $V_{DD} = 5.5\text{V}$ ,  $V_{REF} = 1.0\text{V}$ .



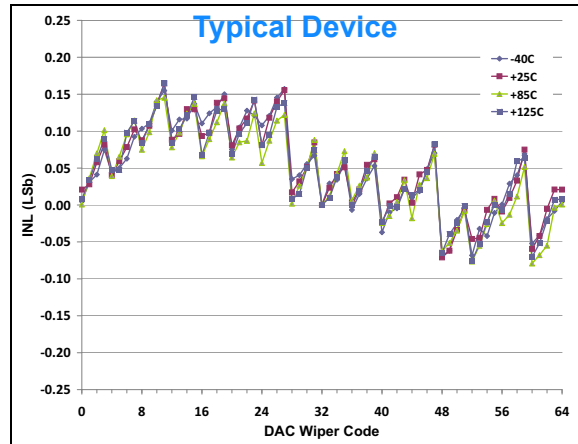
**FIGURE 2-6:** INL vs. Code and Temperature.  $V_{DD} = 3.6\text{V}$ ,  $V_{REF} = 1.0\text{V}$ .

# MCP47DA1

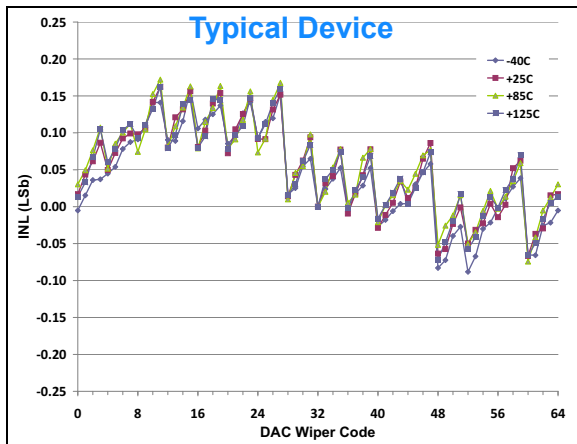
Note: Unless otherwise indicated,  $T_A = +25^\circ\text{C}$ ,  $V_{DD} = V_{REF} = 5\text{V}$ ,  $V_{SS} = 0\text{V}$ ,  $R_L = 5\text{ k}\Omega$ ,  $C_L = 1\text{ nF}$ .



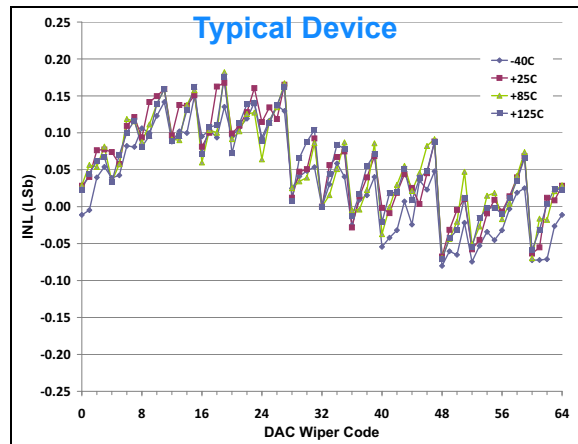
**FIGURE 2-7:** INL vs. Code and Temperature.  $V_{DD} = 3.0\text{V}$ ,  $V_{REF} = 3.0\text{V}$ .



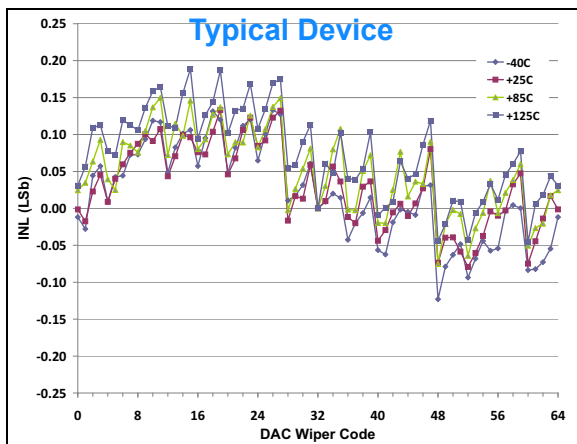
**FIGURE 2-10:** INL vs. Code and Temperature.  $V_{DD} = 2.7\text{V}$ ,  $V_{REF} = 1.65\text{V}$ .



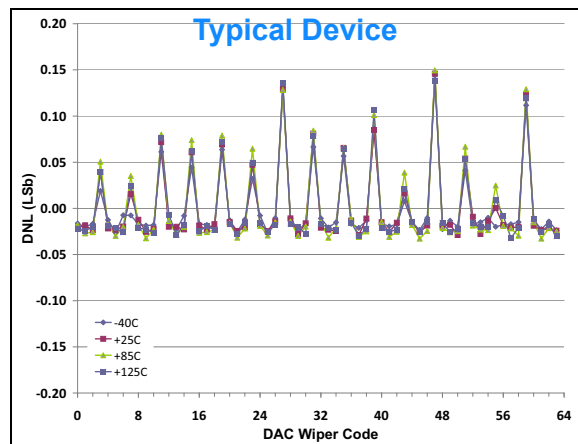
**FIGURE 2-8:** INL vs. Code and Temperature.  $V_{DD} = 3.0\text{V}$ ,  $V_{REF} = 1.65\text{V}$ .



**FIGURE 2-11:** INL vs. Code and Temperature.  $V_{DD} = 2.7\text{V}$ ,  $V_{REF} = 1.0\text{V}$ .

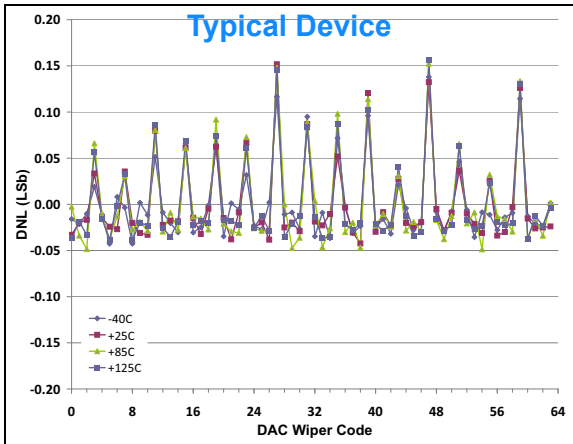


**FIGURE 2-9:** INL vs. Code and Temperature.  $V_{DD} = 3.0\text{V}$ ,  $V_{REF} = 1.0\text{V}$ .

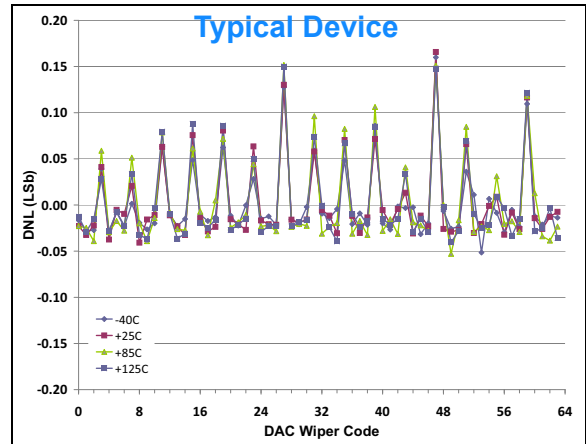


**FIGURE 2-12:** DNL vs. Code and Temperature.  $V_{DD} = 5.5\text{V}$ ,  $V_{REF} = 5.5\text{V}$

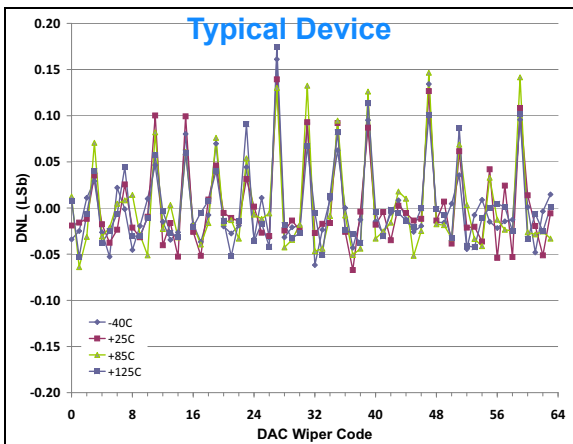
**Note:** Unless otherwise indicated,  $T_A = +25^\circ\text{C}$ ,  $V_{DD} = V_{REF} = 5\text{V}$ ,  $V_{SS} = 0\text{V}$ ,  $R_L = 5\text{ k}\Omega$ ,  $C_L = 1\text{ nF}$ .



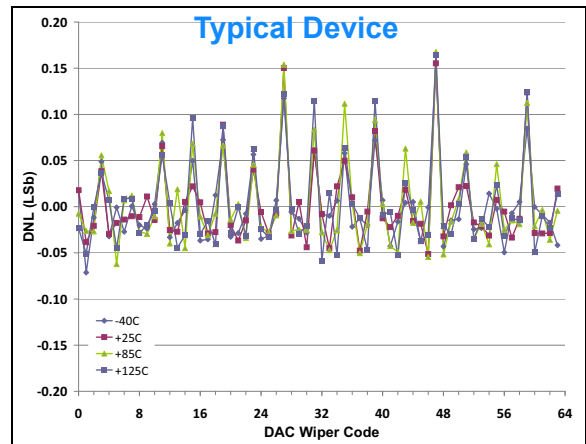
**FIGURE 2-13:** DNL vs. Code and Temperature.  $V_{DD} = 5.5\text{V}$ ,  $V_{REF} = 1.65\text{V}$



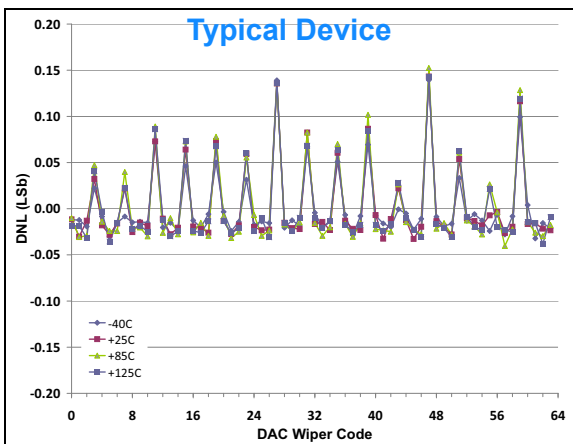
**FIGURE 2-16:** DNL vs. Code and Temperature.  $V_{DD} = 3.6\text{V}$ ,  $V_{REF} = 1.65\text{V}$



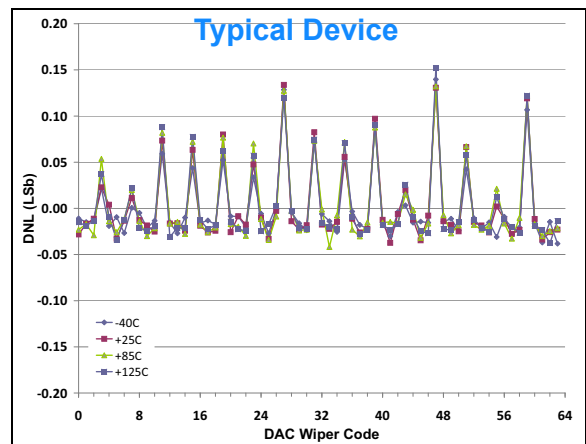
**FIGURE 2-14:** DNL vs. Code and Temperature.  $V_{DD} = 5.5\text{V}$ ,  $V_{REF} = 1.0\text{V}$



**FIGURE 2-17:** DNL vs. Code and Temperature.  $V_{DD} = 3.6\text{V}$ ,  $V_{REF} = 1.0\text{V}$



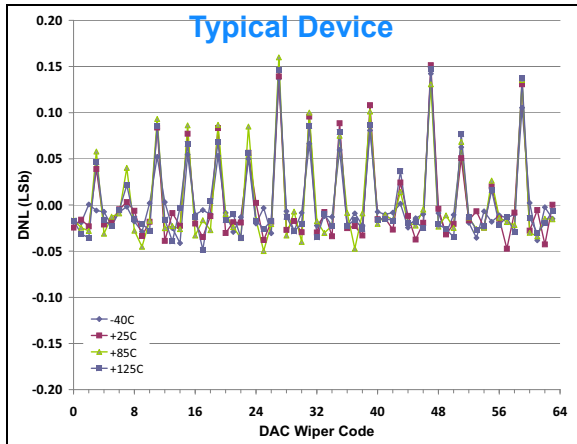
**FIGURE 2-15:** DNL vs. Code and Temperature.  $V_{DD} = 3.6\text{V}$ ,  $V_{REF} = 3.6\text{V}$



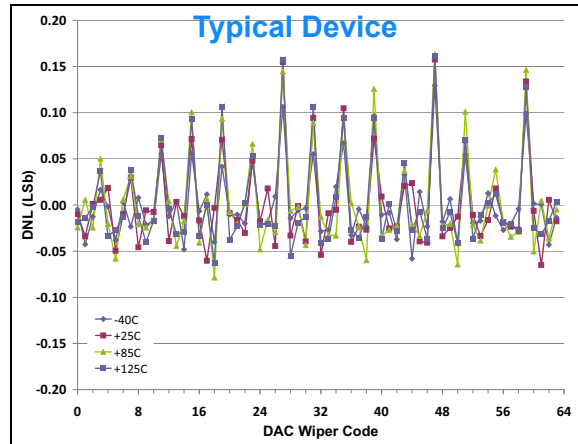
**FIGURE 2-18:** DNL vs. Code and Temperature.  $V_{DD} = 3.0\text{V}$ ,  $V_{REF} = 3.0\text{V}$

# MCP47DA1

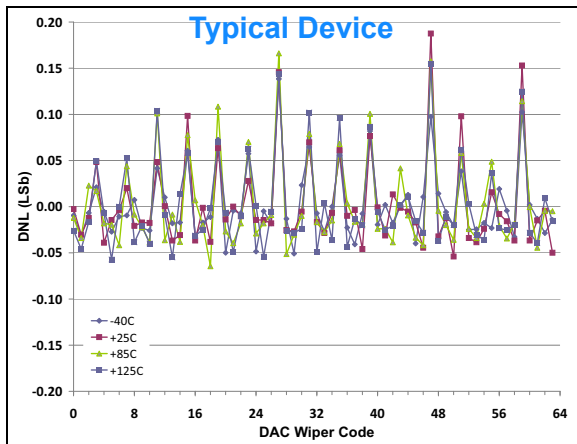
Note: Unless otherwise indicated,  $T_A = +25^\circ\text{C}$ ,  $V_{DD} = V_{REF} = 5\text{V}$ ,  $V_{SS} = 0\text{V}$ ,  $R_L = 5\text{ k}\Omega$ ,  $C_L = 1\text{ nF}$ .



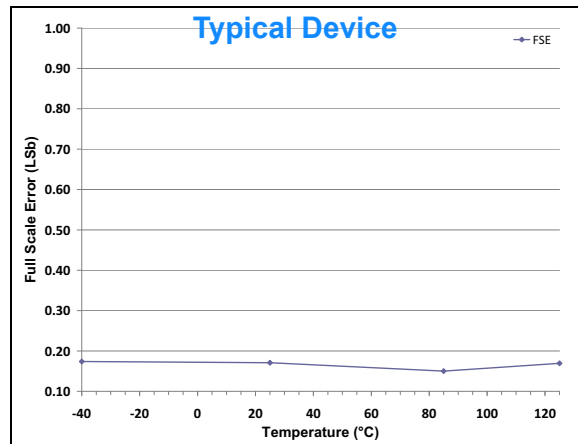
**FIGURE 2-19:** DNL vs. Code and Temperature.  $V_{DD} = 3.0\text{V}$ ,  $V_{REF} = 1.65\text{V}$



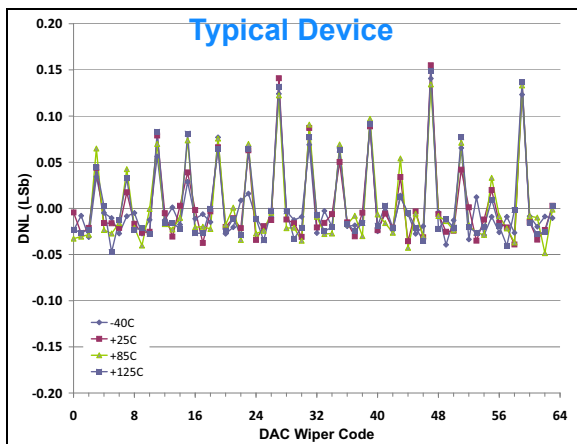
**FIGURE 2-22:** DNL vs. Code and Temperature.  $V_{DD} = 2.7\text{V}$ ,  $V_{REF} = 1.0\text{V}$



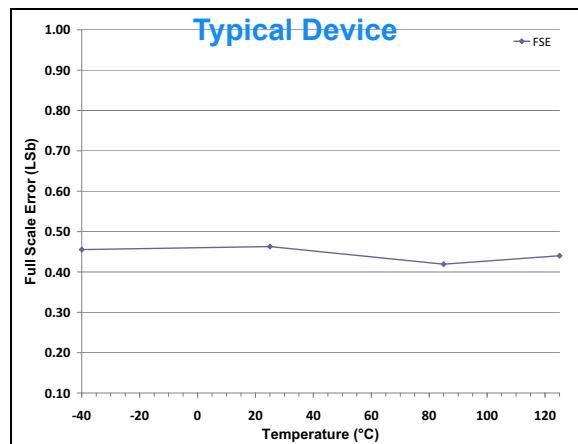
**FIGURE 2-20:** DNL vs. Code and Temperature.  $V_{DD} = 3.0\text{V}$ ,  $V_{REF} = 1.0\text{V}$



**FIGURE 2-23:** Full-Scale Error (FSE) vs. Temperature.  $V_{DD} = 5.5\text{V}$ ,  $V_{REF} = 5.5\text{V}$ .

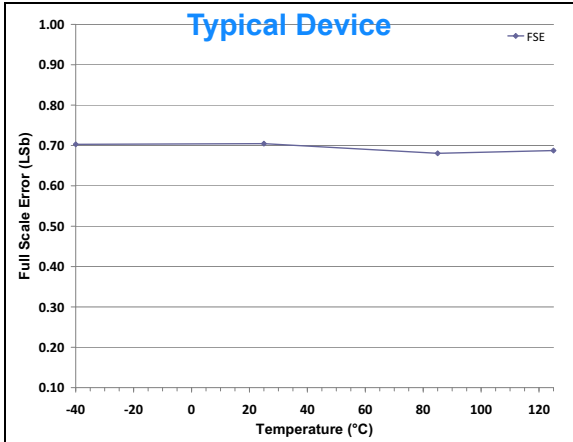


**FIGURE 2-21:** DNL vs. Code and Temperature.  $V_{DD} = 2.7\text{V}$ ,  $V_{REF} = 1.65\text{V}$

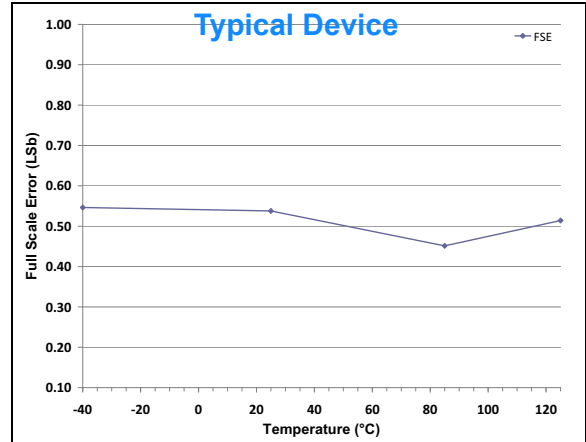


**FIGURE 2-24:** Full-Scale Error (FSE) vs. Temperature.  $V_{DD} = 5.5\text{V}$ ,  $V_{REF} = 1.65\text{V}$ .

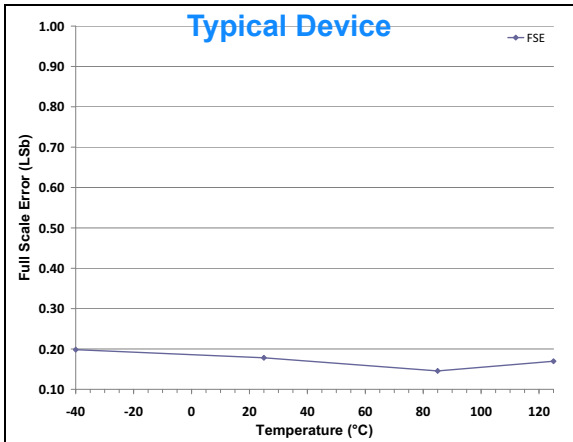
**Note:** Unless otherwise indicated,  $T_A = +25^\circ\text{C}$ ,  $V_{DD} = V_{REF} = 5\text{V}$ ,  $V_{SS} = 0\text{V}$ ,  $R_L = 5\text{ k}\Omega$ ,  $C_L = 1\text{ nF}$ .



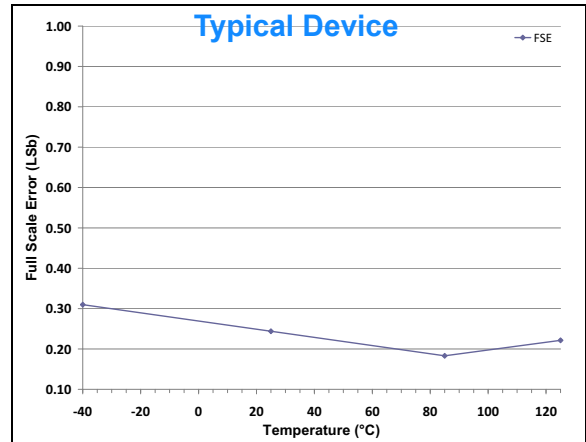
**FIGURE 2-25:** Full-Scale Error (FSE) vs. Temperature.  $V_{DD} = 5.5\text{V}$ ,  $V_{REF} = 1.0\text{V}$ .



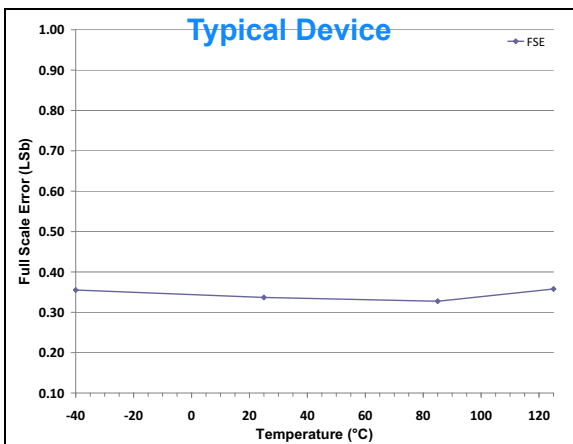
**FIGURE 2-28:** Full-Scale Error (FSE) vs. Temperature.  $V_{DD} = 3.6\text{V}$ ,  $V_{REF} = 1.0\text{V}$



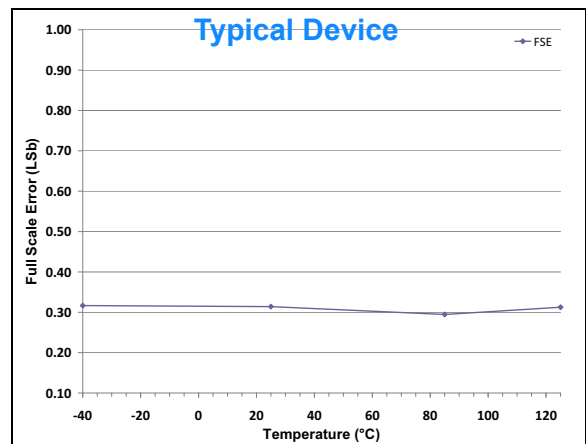
**FIGURE 2-26:** Full-Scale Error (FSE) vs. Temperature.  $V_{DD} = 3.6\text{V}$ ,  $V_{REF} = 3.6\text{V}$ .



**FIGURE 2-29:** Full-Scale Error (FSE) vs. Temperature.  $V_{DD} = 3.0\text{V}$ ,  $V_{REF} = 3.0\text{V}$



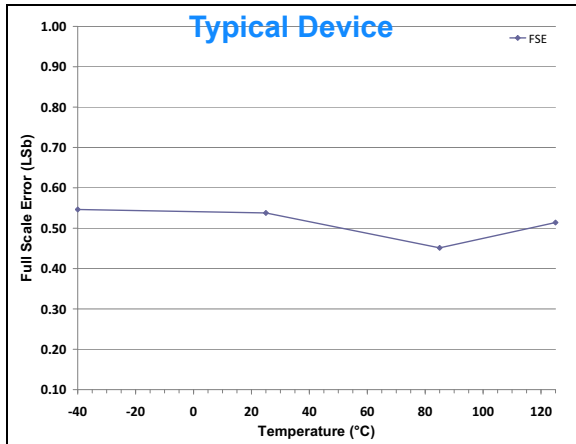
**FIGURE 2-27:** Full-Scale Error (FSE) vs. Temperature.  $V_{DD} = 3.6\text{V}$ ,  $V_{REF} = 1.65\text{V}$ .



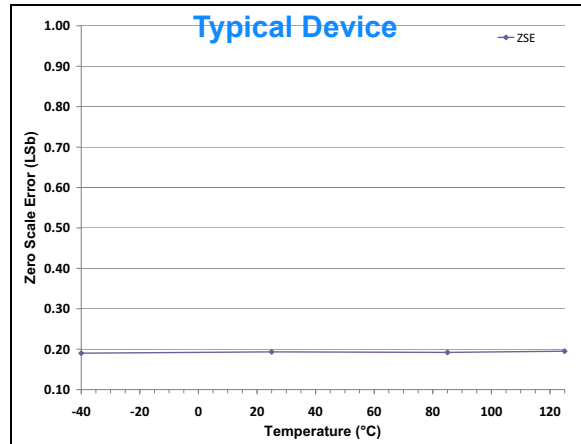
**FIGURE 2-30:** Full-Scale Error (FSE) vs. Temperature.  $V_{DD} = 3.0\text{V}$ ,  $V_{REF} = 1.65\text{V}$ .

# MCP47DA1

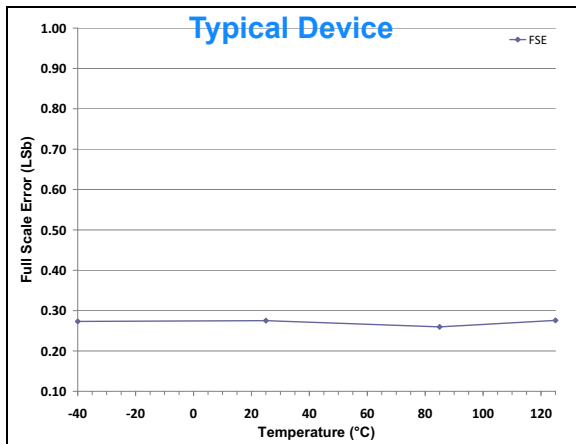
**Note:** Unless otherwise indicated,  $T_A = +25^\circ\text{C}$ ,  $V_{DD} = V_{REF} = 5\text{V}$ ,  $V_{SS} = 0\text{V}$ ,  $R_L = 5\text{ k}\Omega$ ,  $C_L = 1\text{ nF}$ .



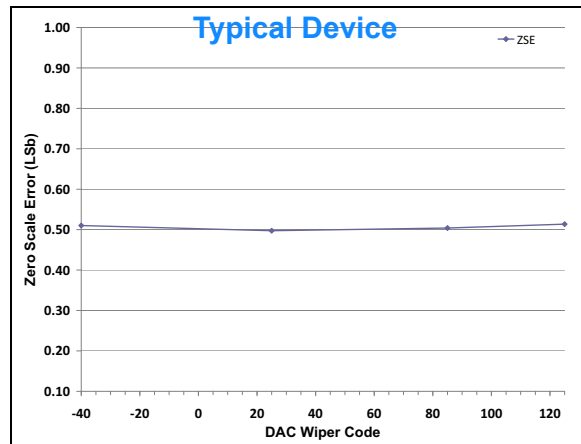
**FIGURE 2-31:** Full-Scale Error (FSE) vs. Temperature.  $V_{DD} = 3.0\text{V}$ ,  $V_{REF} = 1.0\text{V}$



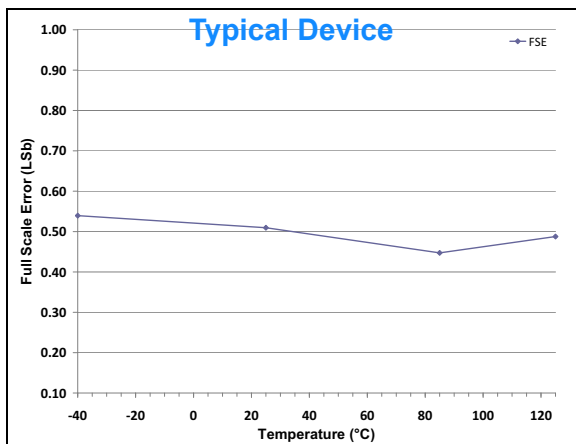
**FIGURE 2-34:** Zero-Scale Error (ZSE) vs. Temperature.  $V_{DD} = 5.5\text{V}$ ,  $V_{REF} = 5.5\text{V}$



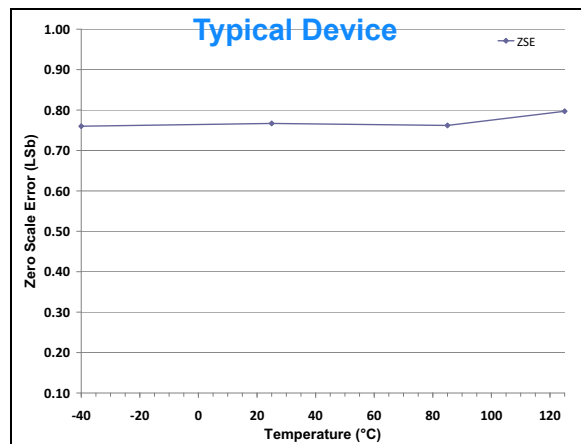
**FIGURE 2-32:** Full-Scale Error (FSE) vs. Temperature.  $V_{DD} = 2.7\text{V}$ ,  $V_{REF} = 1.65\text{V}$ .



**FIGURE 2-35:** Zero-Scale Error (ZSE) vs. Temperature.  $V_{DD} = 5.5\text{V}$ ,  $V_{REF} = 1.65\text{V}$



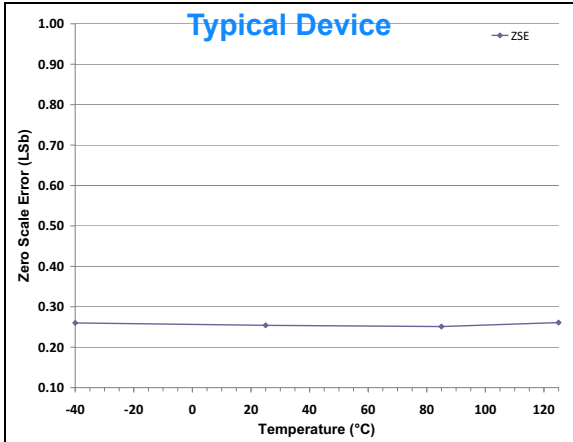
**FIGURE 2-33:** Full-Scale Error (FSE) vs. Temperature.  $V_{DD} = 2.7\text{V}$ ,  $V_{REF} = 1.0\text{V}$



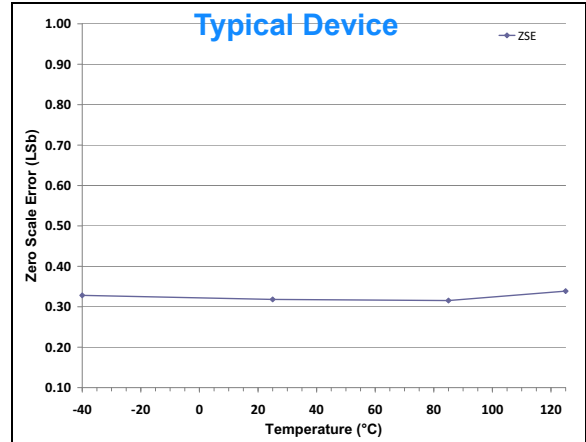
**FIGURE 2-36:** Zero-Scale Error (ZSE) vs. Temperature.  $V_{DD} = 5.5\text{V}$ ,  $V_{REF} = 1.0\text{V}$



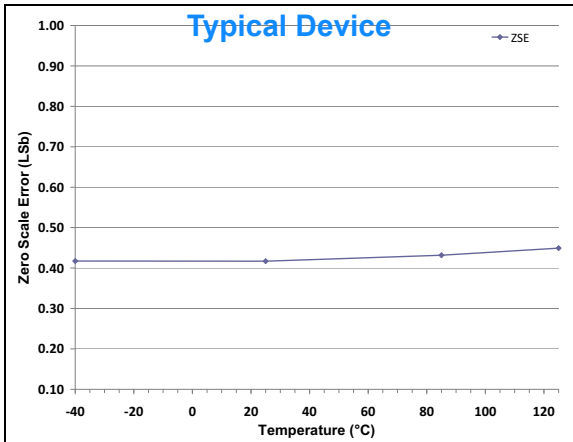
**Note:** Unless otherwise indicated,  $T_A = +25^\circ\text{C}$ ,  $V_{DD} = V_{REF} = 5\text{V}$ ,  $V_{SS} = 0\text{V}$ ,  $R_L = 5\text{ k}\Omega$ ,  $C_L = 1\text{ nF}$ .



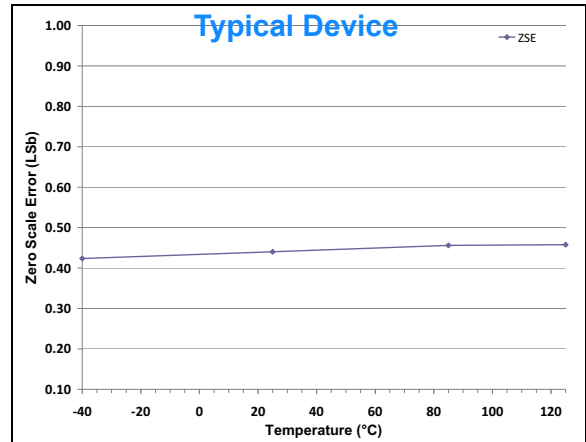
**FIGURE 2-37:** Zero-Scale Error (ZSE) vs. Temperature.  $V_{DD} = 3.6\text{V}$ ,  $V_{REF} = 3.6\text{V}$



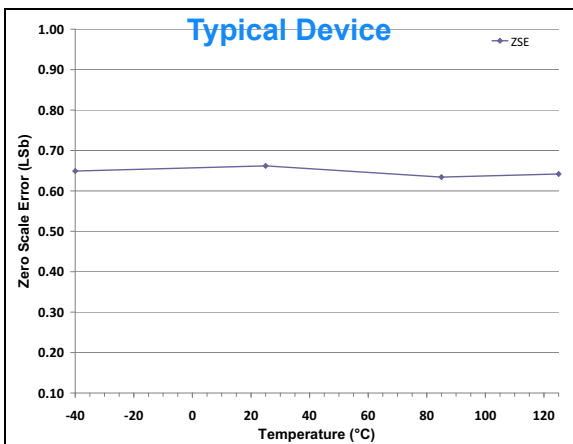
**FIGURE 2-40:** Zero-Scale Error (ZSE) vs. Temperature.  $V_{DD} = 3.0\text{V}$ ,  $V_{REF} = 3.0\text{V}$



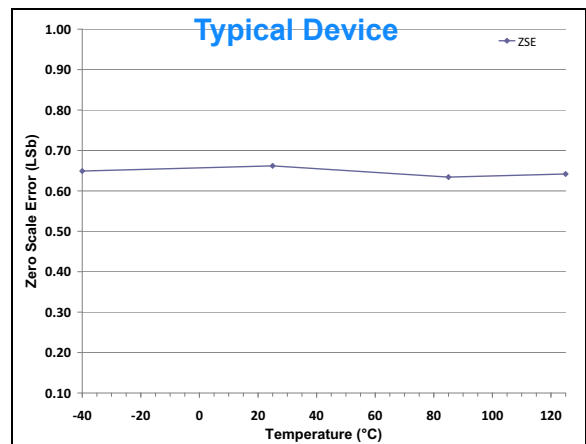
**FIGURE 2-38:** Zero-Scale Error (ZSE) vs. Temperature.  $V_{DD} = 3.6\text{V}$ ,  $V_{REF} = 1.65\text{V}$



**FIGURE 2-41:** Zero-Scale Error (ZSE) vs. Temperature.  $V_{DD} = 3.0\text{V}$ ,  $V_{REF} = 1.65\text{V}$



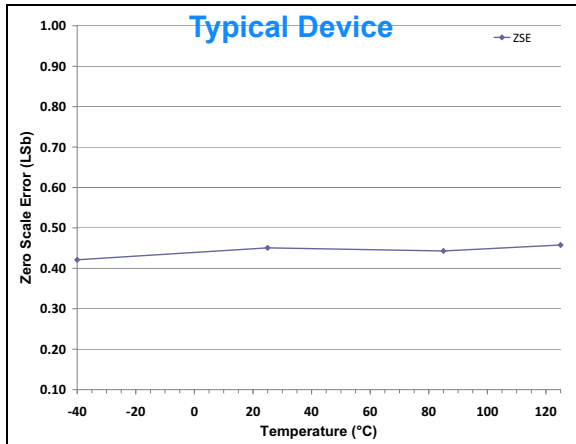
**FIGURE 2-39:** Zero-Scale Error (ZSE) vs. Temperature.  $V_{DD} = 3.6\text{V}$ ,  $V_{REF} = 1.0\text{V}$



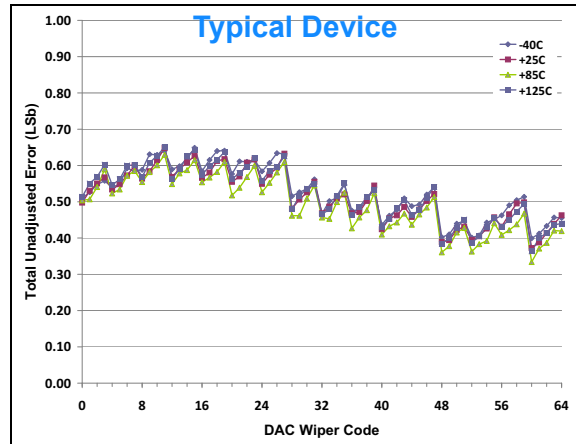
**FIGURE 2-42:** Zero-Scale Error (ZSE) vs. Temperature.  $V_{DD} = 3.0\text{V}$ ,  $V_{REF} = 1.0\text{V}$

# MCP47DA1

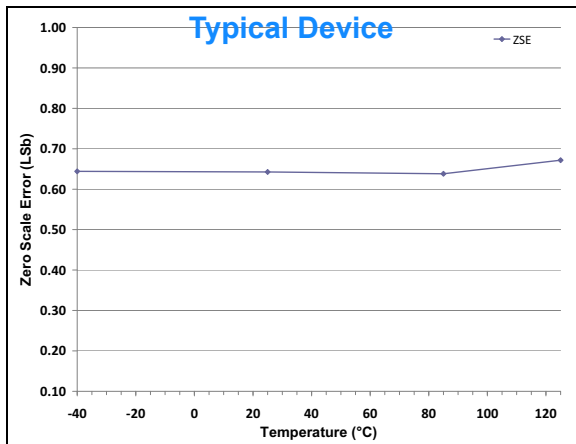
Note: Unless otherwise indicated,  $T_A = +25^\circ\text{C}$ ,  $V_{DD} = V_{REF} = 5\text{V}$ ,  $V_{SS} = 0\text{V}$ ,  $R_L = 5\text{ k}\Omega$ ,  $C_L = 1\text{ nF}$ .



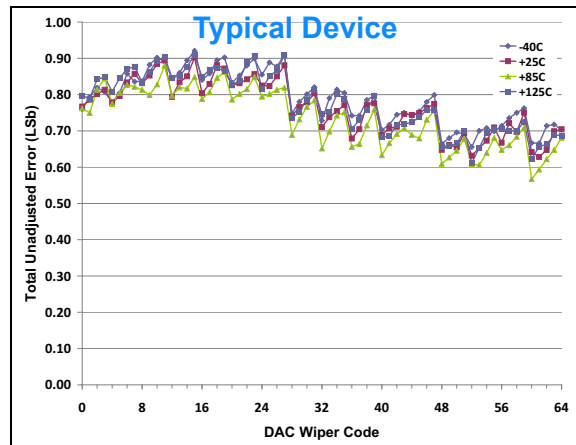
**FIGURE 2-43:** Zero-Scale Error (ZSE) vs. Temperature.  $V_{DD} = 2.7\text{V}$ ,  $V_{REF} = 1.65\text{V}$



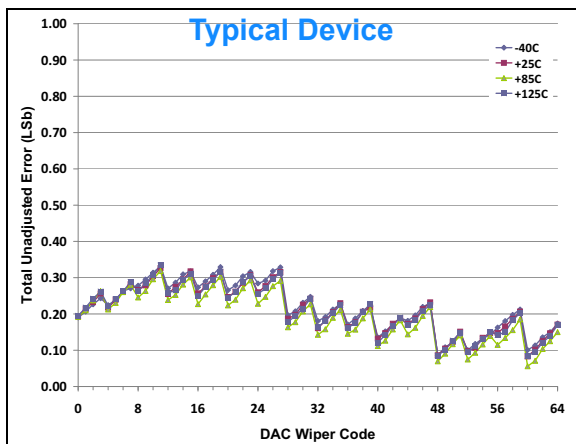
**FIGURE 2-46:** Total Unadjusted Error vs. Code and Temperature.  $V_{DD} = 5.5\text{V}$ ,  $V_{REF} = 1.65\text{V}$ .



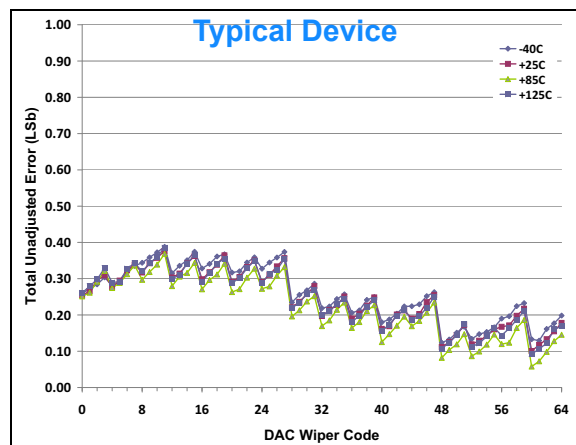
**FIGURE 2-44:** Zero-Scale Error (ZSE) vs. Temperature.  $V_{DD} = 2.7\text{V}$ ,  $V_{REF} = 1.0\text{V}$



**FIGURE 2-47:** Total Unadjusted Error vs. Code and Temperature.  $V_{DD} = 5.5\text{V}$ ,  $V_{REF} = 1.0\text{V}$ .

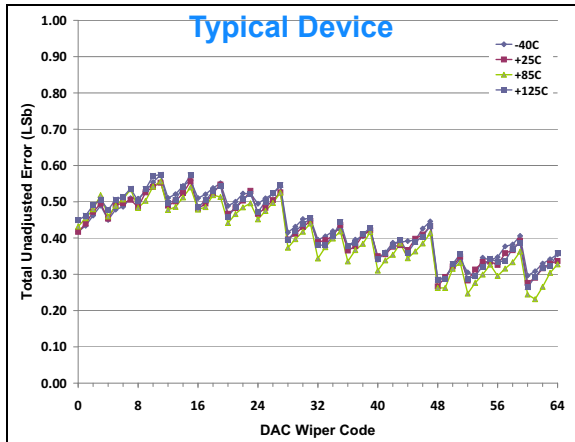


**FIGURE 2-45:** Total Unadjusted Error vs. Code and Temperature.  $V_{DD} = 5.5\text{V}$ ,  $V_{REF} = 5.5\text{V}$ .

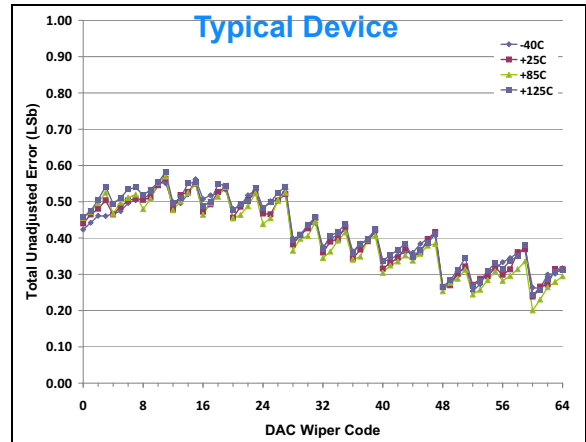


**FIGURE 2-48:** Total Unadjusted Error vs. Code and Temperature.  $V_{DD} = 3.6\text{V}$ ,  $V_{REF} = 3.6\text{V}$ .

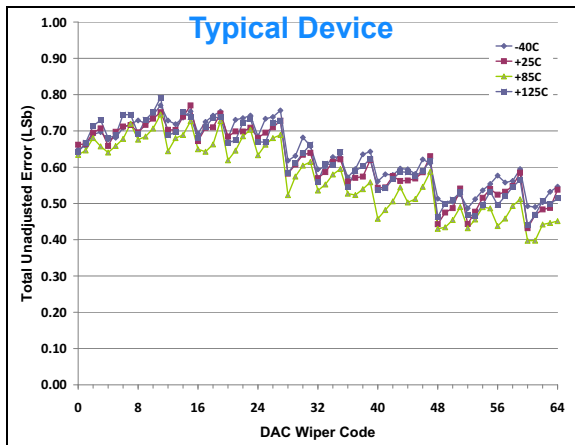
**Note:** Unless otherwise indicated,  $T_A = +25^\circ\text{C}$ ,  $V_{DD} = V_{REF} = 5\text{V}$ ,  $V_{SS} = 0\text{V}$ ,  $R_L = 5\text{ k}\Omega$ ,  $C_L = 1\text{ nF}$ .



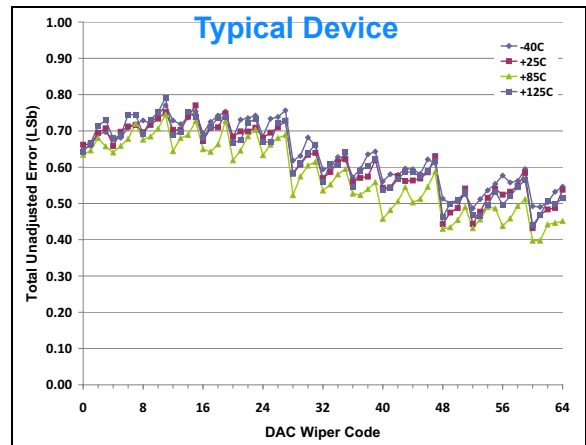
**FIGURE 2-49:** Total Unadjusted Error vs. Code and Temperature.  
 $V_{DD} = 3.6\text{V}$ ,  $V_{REF} = 1.65\text{V}$ .



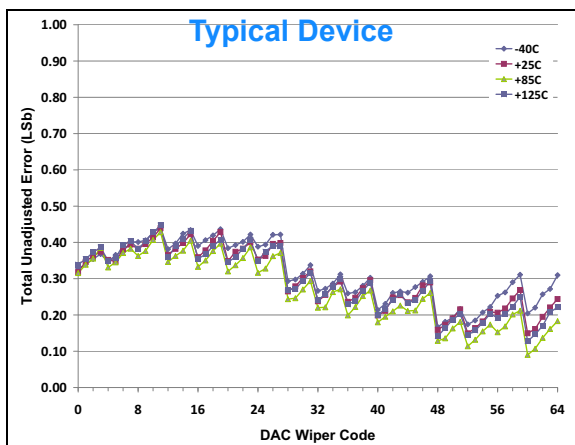
**FIGURE 2-52:** Total Unadjusted Error vs. Code and Temperature.  
 $V_{DD} = 3.0\text{V}$ ,  $V_{REF} = 1.65\text{V}$ .



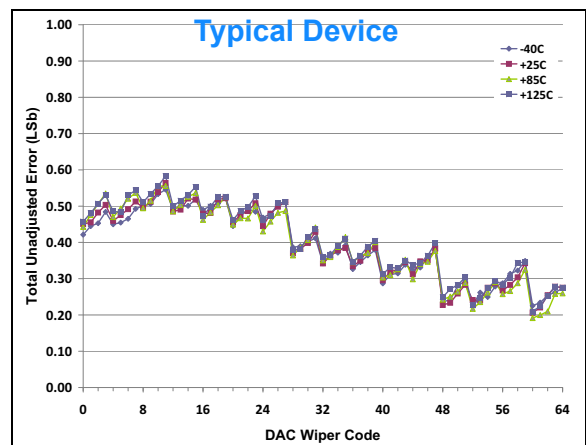
**FIGURE 2-50:** Total Unadjusted Error vs. Code and Temperature.  
 $V_{DD} = 3.6\text{V}$ ,  $V_{REF} = 1.0\text{V}$ .



**FIGURE 2-53:** Total Unadjusted Error vs. Code and Temperature.  
 $V_{DD} = 3.0\text{V}$ ,  $V_{REF} = 1.0\text{V}$ .



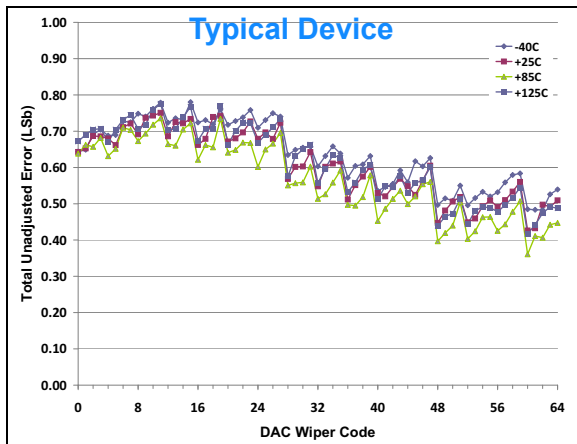
**FIGURE 2-51:** Total Unadjusted Error vs. Code and Temperature.  
 $V_{DD} = 3.0\text{V}$ ,  $V_{REF} = 3.0\text{V}$ .



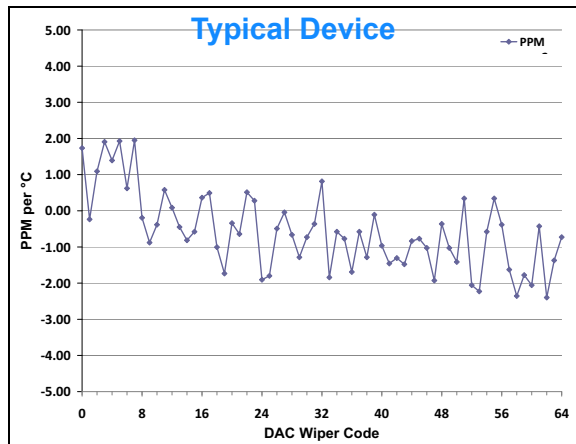
**FIGURE 2-54:** Total Unadjusted Error vs. Code and Temperature.  
 $V_{DD} = 2.7\text{V}$ ,  $V_{REF} = 1.65\text{V}$ .

# MCP47DA1

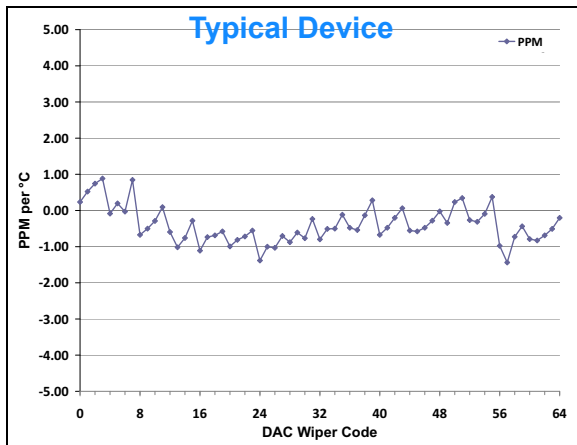
Note: Unless otherwise indicated,  $T_A = +25^\circ\text{C}$ ,  $V_{DD} = V_{REF} = 5\text{V}$ ,  $V_{SS} = 0\text{V}$ ,  $R_L = 5\text{ k}\Omega$ ,  $C_L = 1\text{ nF}$ .



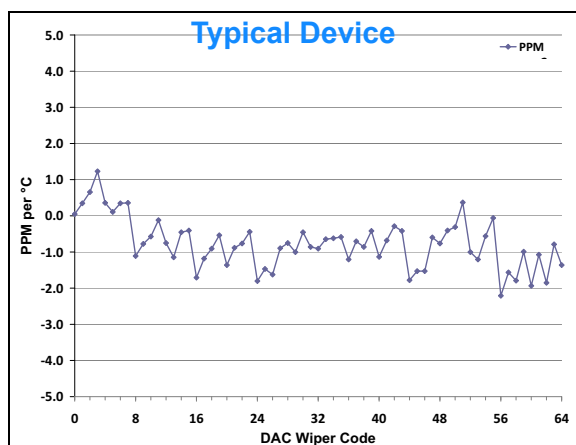
**FIGURE 2-55:** Total Unadjusted Error vs. Code and Temperature.  
 $V_{DD} = 2.7\text{V}$ ,  $V_{REF} = 1.0\text{V}$ .



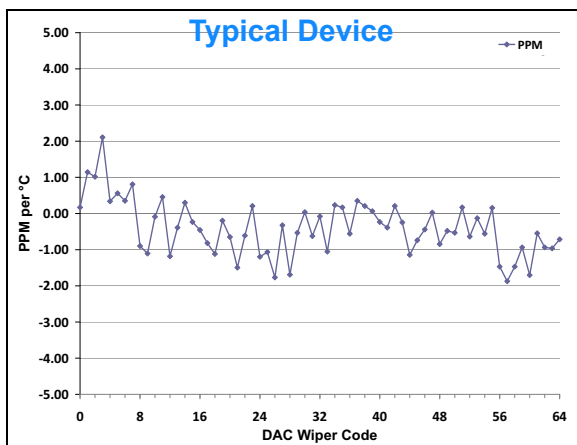
**FIGURE 2-58:**  $V_{OUT}$  Tempco vs. Code ( $((V_{OUT(+125C)} - V_{OUT(-40C)}) / V_{OUT(+25C, Code=FS)}) / 165) * 1,000,000$ ),  $V_{DD} = 5.5\text{V}$ ,  $V_{REF} = 1.0\text{V}$ .



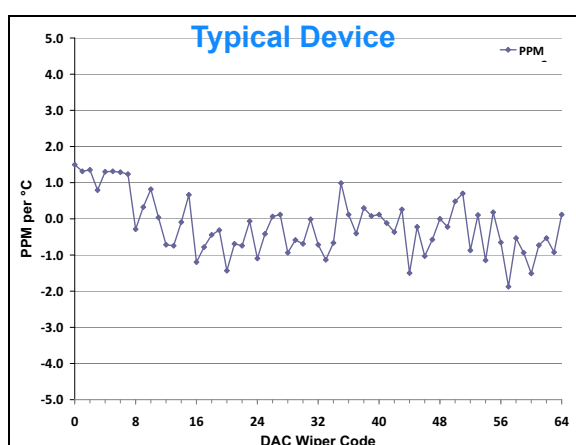
**FIGURE 2-56:**  $V_{OUT}$  Tempco vs. Code ( $((V_{OUT(+125C)} - V_{OUT(-40C)}) / V_{OUT(+25C, Code=FS)}) / 165) * 1,000,000$ ),  $V_{DD} = 5.5\text{V}$ ,  $V_{REF} = 5.5\text{V}$ .



**FIGURE 2-59:**  $V_{OUT}$  Tempco vs. Code ( $((V_{OUT(+125C)} - V_{OUT(-40C)}) / V_{OUT(+25C, Code=FS)}) / 165) * 1,000,000$ ),  $V_{DD} = 3.6\text{V}$ ,  $V_{REF} = 3.6\text{V}$ .

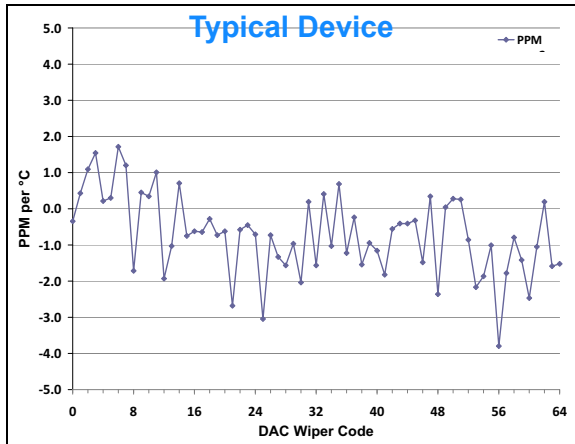


**FIGURE 2-57:**  $V_{OUT}$  Tempco vs. Code ( $((V_{OUT(+125C)} - V_{OUT(-40C)}) / V_{OUT(+25C, Code=FS)}) / 165) * 1,000,000$ ),  $V_{DD} = 5.5\text{V}$ ,  $V_{REF} = 1.65\text{V}$ .

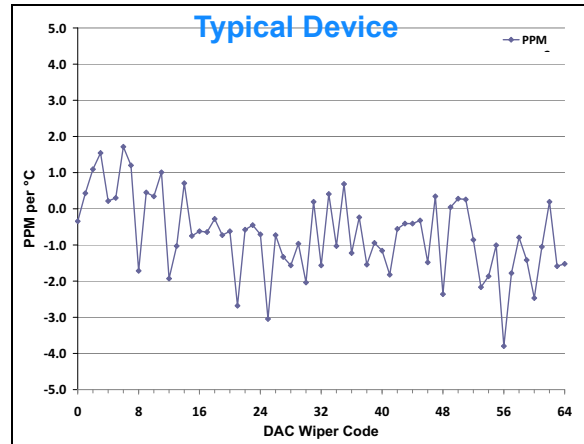


**FIGURE 2-60:**  $V_{OUT}$  Tempco vs. Code ( $((V_{OUT(+125C)} - V_{OUT(-40C)}) / V_{OUT(+25C, Code=FS)}) / 165) * 1,000,000$ ),  $V_{DD} = 3.6\text{V}$ ,  $V_{REF} = 1.65\text{V}$ .

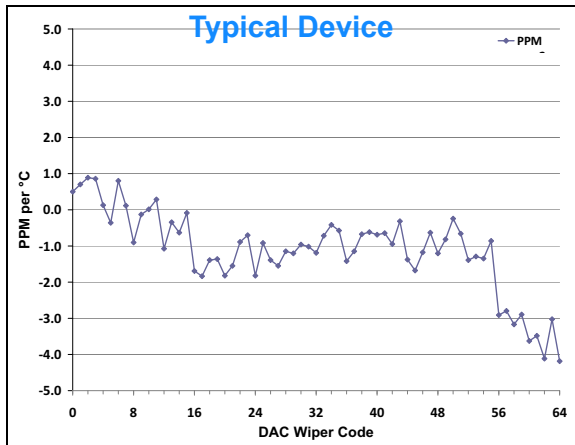
**Note:** Unless otherwise indicated,  $T_A = +25^\circ\text{C}$ ,  $V_{DD} = V_{REF} = 5\text{V}$ ,  $V_{SS} = 0\text{V}$ ,  $R_L = 5\text{ k}\Omega$ ,  $C_L = 1\text{ nF}$ .



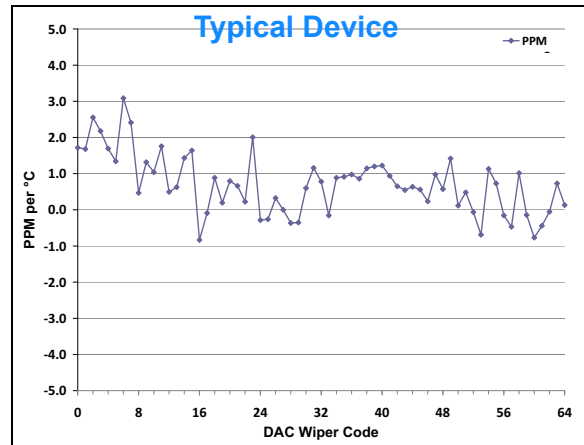
**FIGURE 2-61:**  $V_{OUT}$  Tempco vs. Code  $\left( \left( \frac{V_{OUT(+125C)} - V_{OUT(-40C)}}{V_{OUT(+25C, Code=FS)}} \right) / 165 \right) * 1,000,000$ ,  $V_{DD} = 3.6\text{V}$ ,  $V_{REF} = 1.0\text{V}$ .



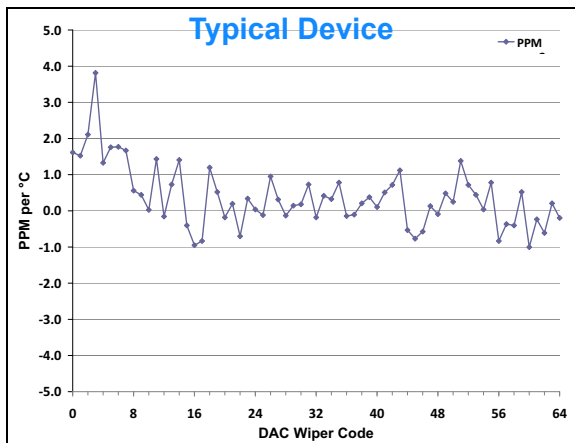
**FIGURE 2-64:**  $V_{OUT}$  Tempco vs. Code  $\left( \left( \frac{V_{OUT(+125C)} - V_{OUT(-40C)}}{V_{OUT(+25C, Code=FS)}} \right) / 165 \right) * 1,000,000$ ,  $V_{DD} = 3.0\text{V}$ ,  $V_{REF} = 1.0\text{V}$ .



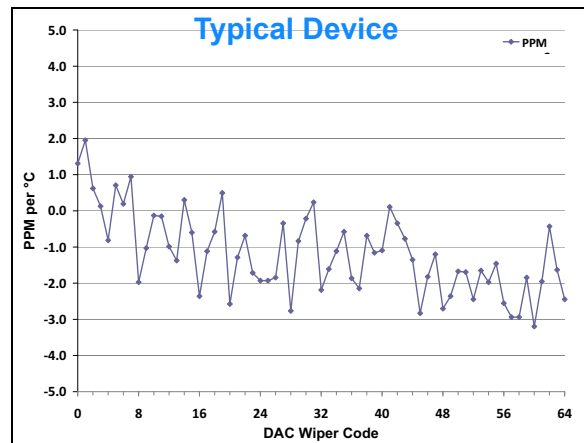
**FIGURE 2-62:**  $V_{OUT}$  Tempco vs. Code  $\left( \left( \frac{V_{OUT(+125C)} - V_{OUT(-40C)}}{V_{OUT(+25C, Code=FS)}} \right) / 165 \right) * 1,000,000$ ,  $V_{DD} = 3.0\text{V}$ ,  $V_{REF} = 3.0\text{V}$ .



**FIGURE 2-65:**  $V_{OUT}$  Tempco vs. Code  $\left( \left( \frac{V_{OUT(+125C)} - V_{OUT(-40C)}}{V_{OUT(+25C, Code=FS)}} \right) / 165 \right) * 1,000,000$ ,  $V_{DD} = 2.7\text{V}$ ,  $V_{REF} = 1.65\text{V}$ .



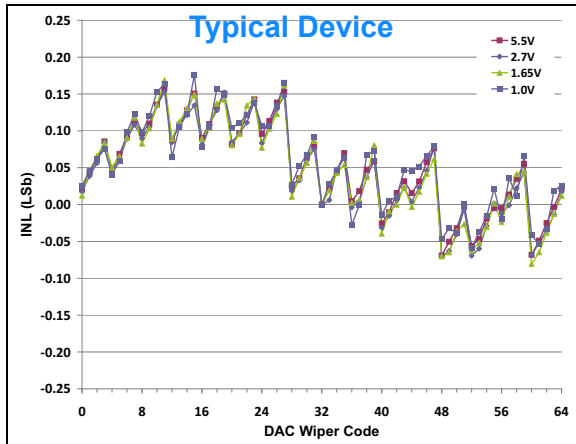
**FIGURE 2-63:**  $V_{OUT}$  Tempco vs. Code  $\left( \left( \frac{V_{OUT(+125C)} - V_{OUT(-40C)}}{V_{OUT(+25C, Code=FS)}} \right) / 165 \right) * 1,000,000$ ,  $V_{DD} = 3.0\text{V}$ ,  $V_{REF} = 1.65\text{V}$ .



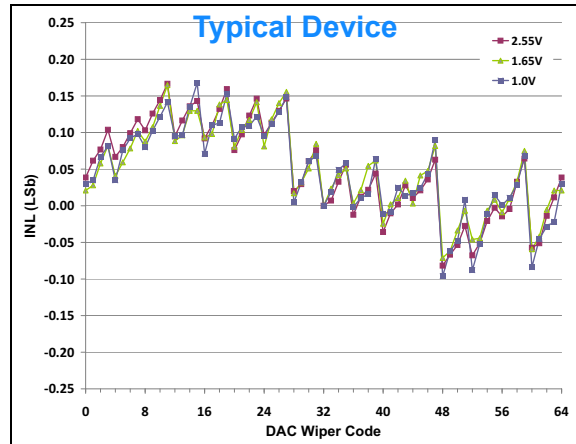
**FIGURE 2-66:**  $V_{OUT}$  Tempco vs. Code  $\left( \left( \frac{V_{OUT(+125C)} - V_{OUT(-40C)}}{V_{OUT(+25C, Code=FS)}} \right) / 165 \right) * 1,000,000$ ,  $V_{DD} = 2.7\text{V}$ ,  $V_{REF} = 1.0\text{V}$ .

# MCP47DA1

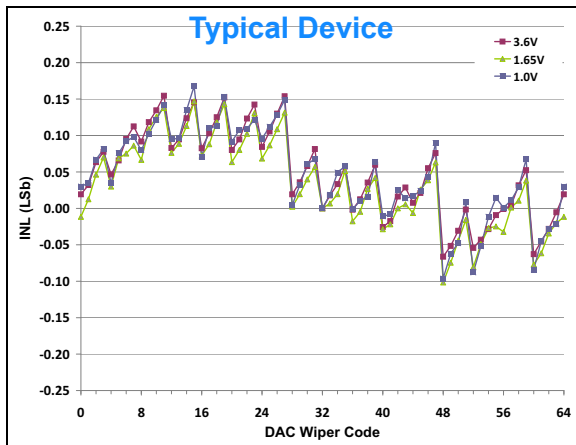
Note: Unless otherwise indicated,  $T_A = +25^\circ\text{C}$ ,  $V_{DD} = V_{REF} = 5\text{V}$ ,  $V_{SS} = 0\text{V}$ ,  $R_L = 5\text{ k}\Omega$ ,  $C_L = 1\text{ nF}$ .



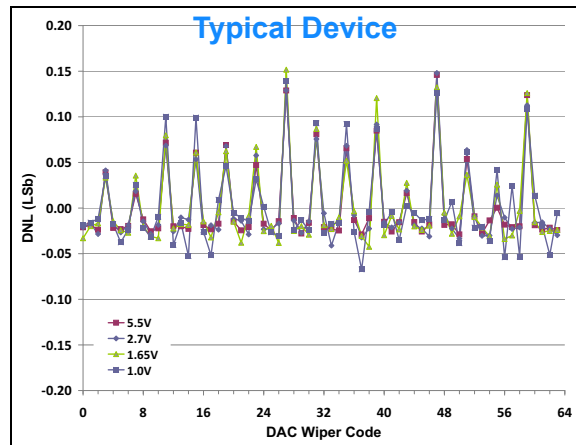
**FIGURE 2-67:** INL vs. Code and  $V_{REF}$   
 $V_{DD} = 5.5\text{V}$ ,  $V_{REF} = 1\text{V}$ ,  $1.65\text{V}$ ,  $2.7\text{V}$ , and  $5.5\text{V}$ ,  
 $\text{Temp} = +25^\circ\text{C}$ .



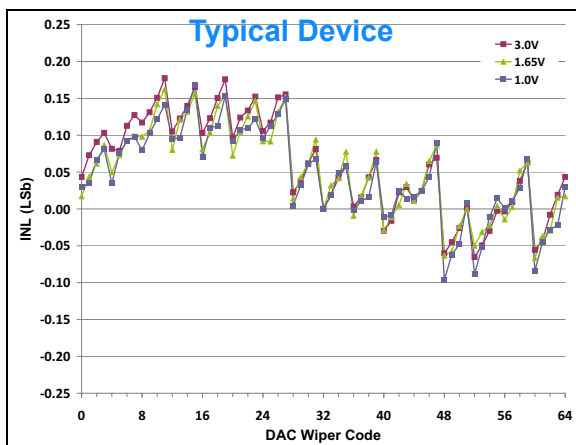
**FIGURE 2-70:** INL vs. Code and  $V_{REF}$   
 $V_{DD} = 2.7\text{V}$ ,  $V_{REF} = 1\text{V}$ ,  $1.65\text{V}$ , and  $2.55\text{V}$ ,  
 $\text{Temp} = +25^\circ\text{C}$ .



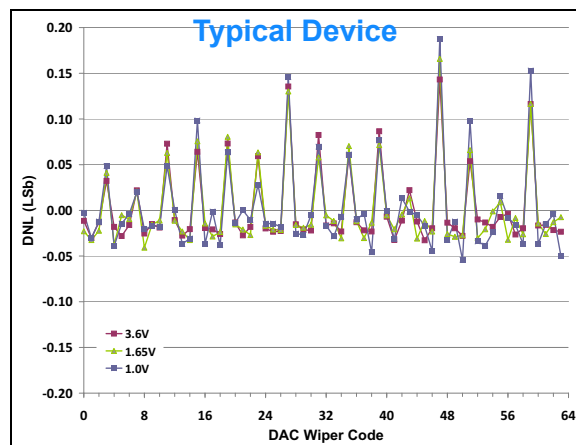
**FIGURE 2-68:** INL vs. Code and  $V_{REF}$   
 $V_{DD} = 3.6\text{V}$ ,  $V_{REF} = 1\text{V}$ ,  $1.65\text{V}$ , and  $3.6\text{V}$ ,  
 $\text{Temp} = +25^\circ\text{C}$ .



**FIGURE 2-71:** DNL vs. Code and  $V_{REF}$   
 $V_{DD} = 5.5\text{V}$ ,  $V_{REF} = 1\text{V}$ ,  $1.65\text{V}$ ,  $2.7\text{V}$ , and  $5.5\text{V}$ ,  
 $\text{Temp} = +25^\circ\text{C}$ .

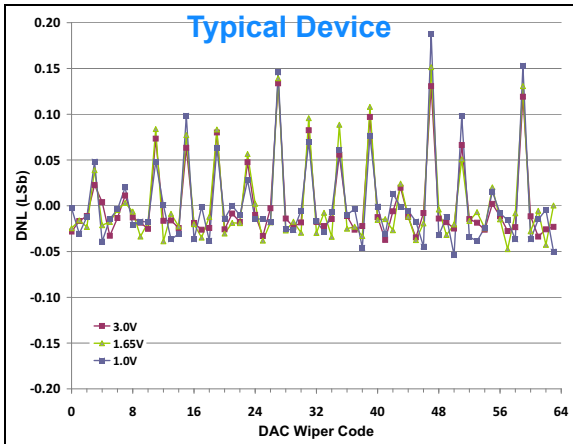


**FIGURE 2-69:** INL vs. Code and  $V_{REF}$   
 $V_{DD} = 3.0\text{V}$ ,  $V_{REF} = 1\text{V}$ ,  $1.65\text{V}$ , and  $5.5\text{V}$ ,  
 $\text{Temp} = +25^\circ\text{C}$ .

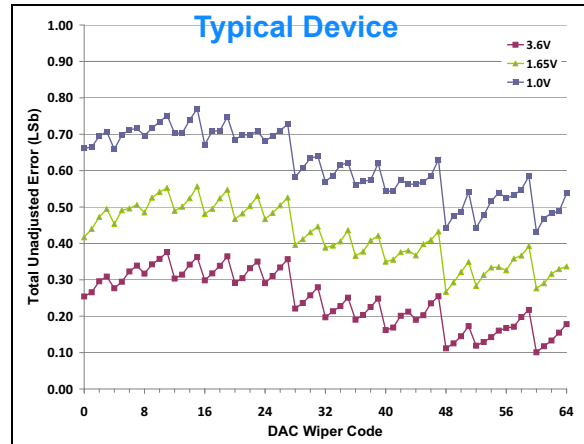


**FIGURE 2-72:** DNL vs. Code and  $V_{REF}$   
 $V_{DD} = 3.6\text{V}$ ,  $V_{REF} = 1\text{V}$ ,  $1.65\text{V}$ , and  $3.6\text{V}$ ,  
 $\text{Temp} = +25^\circ\text{C}$ .

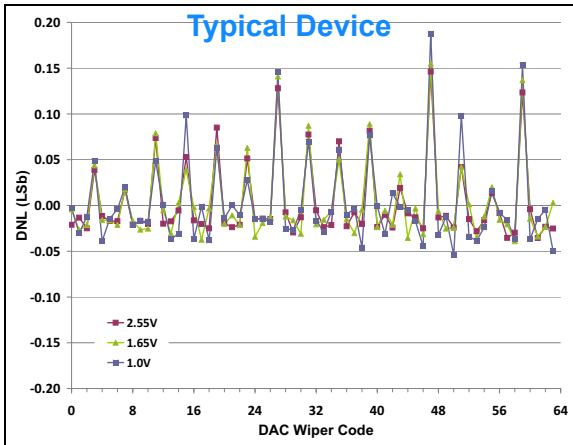
**Note:** Unless otherwise indicated,  $T_A = +25^\circ\text{C}$ ,  $V_{DD} = V_{REF} = 5\text{V}$ ,  $V_{SS} = 0\text{V}$ ,  $R_L = 5\text{ k}\Omega$ ,  $C_L = 1\text{ nF}$ .



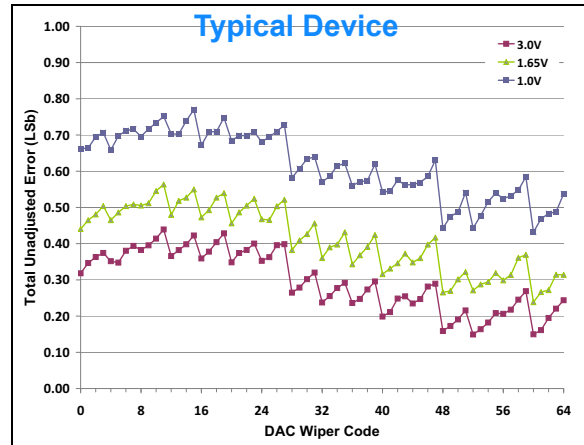
**FIGURE 2-73:** DNL vs. Code and  $V_{REF}$   
 $V_{DD} = 3.0\text{V}$ ,  $V_{REF} = 1\text{V}$ ,  $1.65\text{V}$ , and  $3.0\text{V}$ ,  
 $\text{Temp} = +25^\circ\text{C}$ .



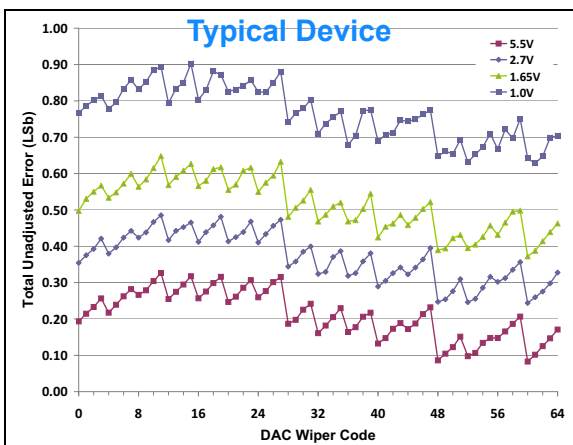
**FIGURE 2-76:** Total Unadjusted Error vs.  
 Code and  $V_{REF}$   $V_{DD} = 3.6\text{V}$ ,  $V_{REF} = 1\text{V}$ ,  $1.65\text{V}$ ,  
 and  $3.6\text{V}$ ,  $\text{Temp} = +25^\circ\text{C}$ .



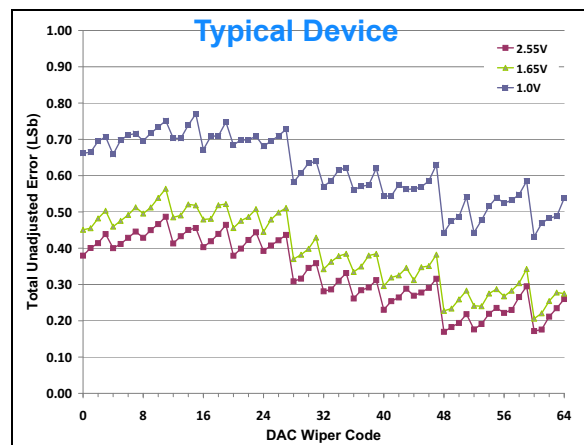
**FIGURE 2-74:** DNL vs. Code and  $V_{REF}$   
 $V_{DD} = 2.7\text{V}$ ,  $V_{REF} = 1\text{V}$ ,  $1.65\text{V}$ , and  $2.55\text{V}$ ,  
 $\text{Temp} = +25^\circ\text{C}$ .



**FIGURE 2-77:** Total Unadjusted Error vs.  
 Code and  $V_{REF}$   $V_{DD} = 3.0\text{V}$ ,  $V_{REF} = 1\text{V}$ ,  $1.65\text{V}$ ,  
 and  $5.5\text{V}$ ,  $\text{Temp} = +25^\circ\text{C}$ .



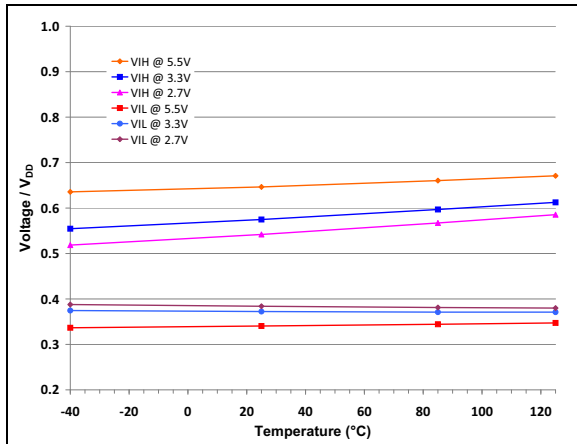
**FIGURE 2-75:** Total Unadjusted Error vs.  
 Code and  $V_{REF}$   $V_{DD} = 5.5\text{V}$ ,  $V_{REF} = 1\text{V}$ ,  $1.65\text{V}$ ,  
 $2.7\text{V}$ , and  $5.5\text{V}$ ,  $\text{Temp} = +25^\circ\text{C}$ .



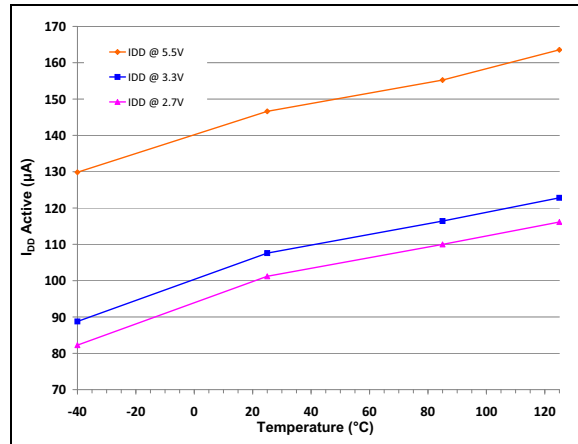
**FIGURE 2-78:** Total Unadjusted Error vs.  
 Code and  $V_{REF}$   $V_{DD} = 2.7\text{V}$ ,  $V_{REF} = 1\text{V}$ ,  $1.65\text{V}$ ,  
 and  $2.55\text{V}$ ,  $\text{Temp} = +25^\circ\text{C}$ .

# MCP47DA1

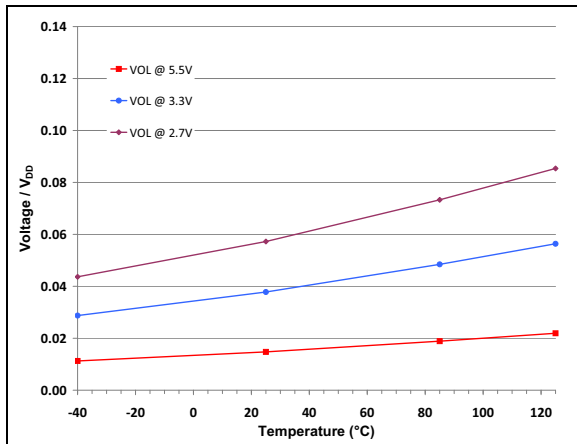
Note: Unless otherwise indicated,  $T_A = +25^\circ\text{C}$ ,  $V_{DD} = V_{REF} = 5\text{V}$ ,  $V_{SS} = 0\text{V}$ ,  $R_L = 5\text{ k}\Omega$ ,  $C_L = 1\text{ nF}$ .



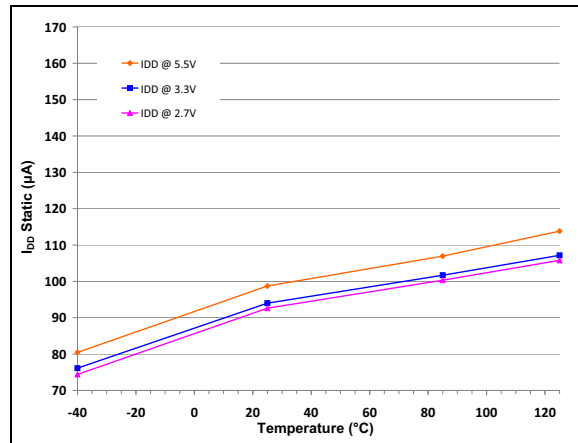
**FIGURE 2-79:**  $V_{IH} / V_{IL}$  Threshold of SDA/SCL Inputs vs. Temperature and  $V_{DD}$ .



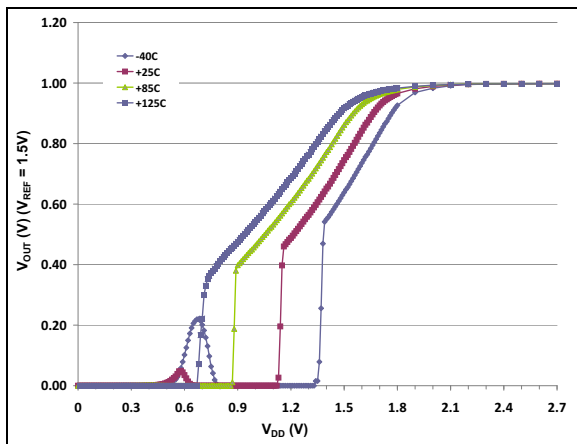
**FIGURE 2-82:** Interface Active Current ( $I_{DD}$ ) vs. SCL Frequency ( $f_{SCL}$ ) and Temperature  $V_{DD} = 2.7\text{V}$  and  $5.5\text{V}$ ,  $V_{REF} = 1.5\text{V}$  and  $V_{DD}$ . (no load on  $V_{OUT}$ ).



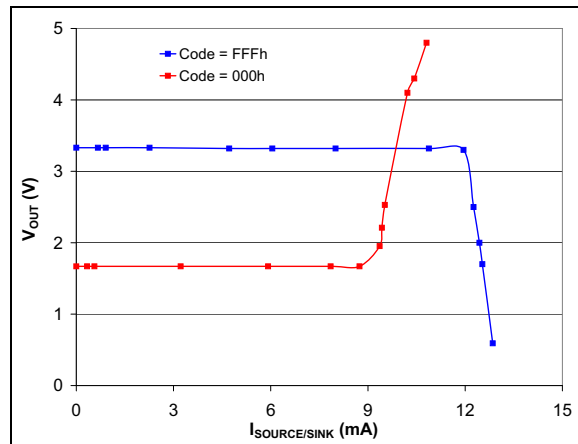
**FIGURE 2-80:**  $V_{OL}$  (SDA) vs.  $V_{DD}$  and Temperature.



**FIGURE 2-83:** Interface Inactive Current ( $I_{SHDN}$ ) vs. Temperature.  $V_{DD} = 2.7\text{V}$  and  $5.5\text{V}$ ,  $V_{REF} = 1.5\text{V}$  and  $V_{DD}$ . (no load on  $V_{OUT}$ ;  $SCL = SDA = V_{DD}$ ).



**FIGURE 2-81:**  $V_{OUT}$  vs.  $V_{DD}$  and Temperature. For  $V_{DD}$  Power-Up and Power-Down with  $V_{REF} = 1.5\text{V}$ .

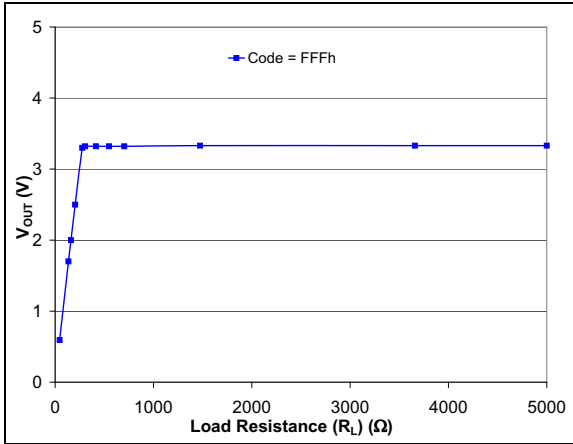


**FIGURE 2-84:**  $V_{OUT}$  vs. Source/Sink Current.  $V_{DD} = 5.0\text{V}$ .

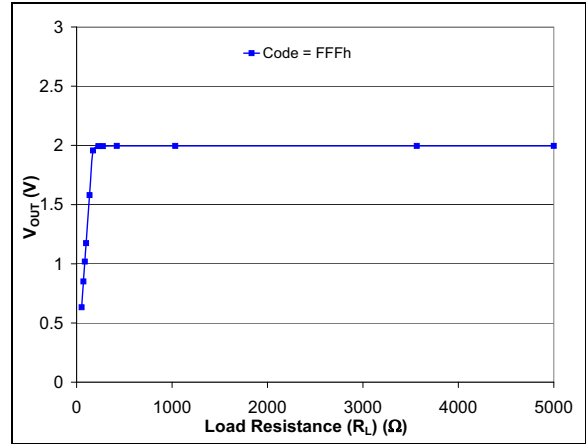


# MCP47DA1

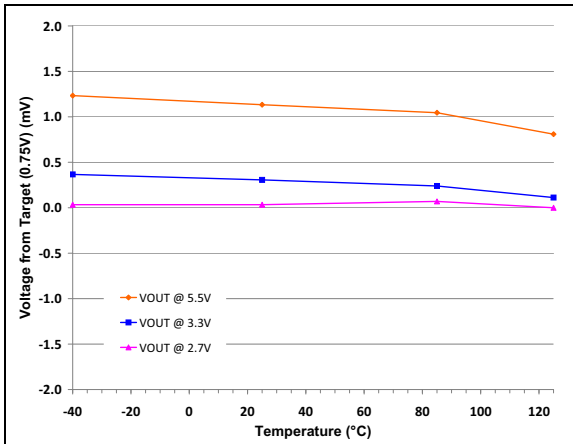
**Note:** Unless otherwise indicated,  $T_A = +25^\circ\text{C}$ ,  $V_{DD} = V_{REF} = 5\text{V}$ ,  $V_{SS} = 0\text{V}$ ,  $R_L = 5\text{ k}\Omega$ ,  $C_L = 1\text{ nF}$ .



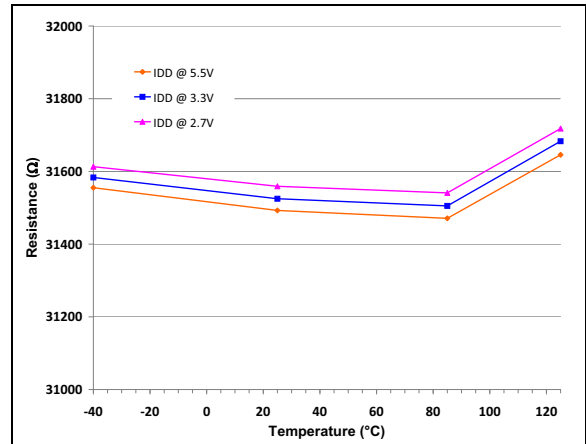
**FIGURE 2-85:**  $V_{OUT}$  vs. Resistive Load.  $V_{DD} = 5.0\text{V}$ .



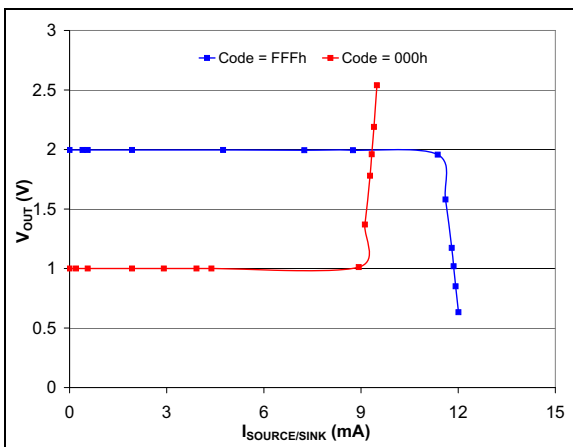
**FIGURE 2-88:**  $V_{OUT}$  vs. Resistive Load.  $V_{DD} = 3.0\text{V}$ .



**FIGURE 2-86:**  $V_{OUT}$  Accuracy vs.  $V_{DD}$  and Temperature.



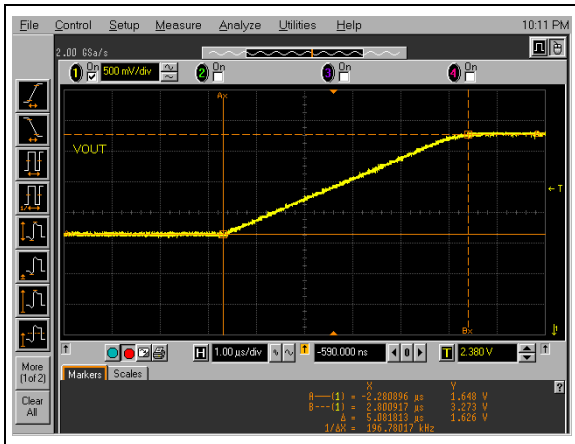
**FIGURE 2-89:**  $R_{VREF}$  Resistances vs.  $V_{DD}$  and Temperature.



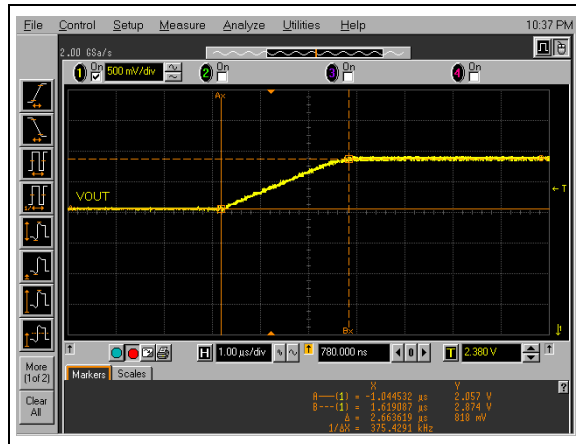
**FIGURE 2-87:**  $V_{OUT}$  vs. Source/Sink Current.  $V_{DD} = 3.0\text{V}$ .

# MCP47DA1

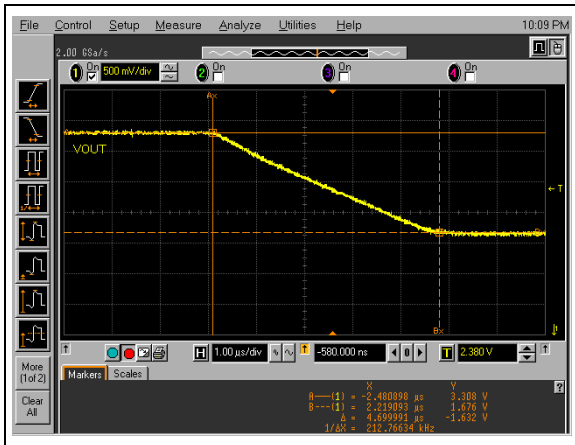
**Note:** Unless otherwise indicated,  $T_A = +25^\circ\text{C}$ ,  $V_{DD} = V_{REF} = 5\text{V}$ ,  $V_{SS} = 0\text{V}$ ,  $R_L = 5\text{k}\Omega$ ,  $C_L = 1\text{nF}$ .



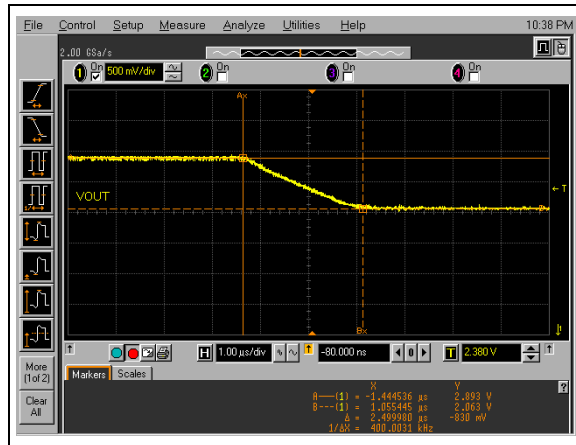
**FIGURE 2-90:** Zero-Scale to Full-Scale Settling Time (20h to 60h),  $V_{DD} = 5.0\text{V}$ ,  $V_{REF} = 5.0\text{V}$ ,  $R_L = 5\text{k}\Omega$ ,  $C_L = 1\text{nF}$ .



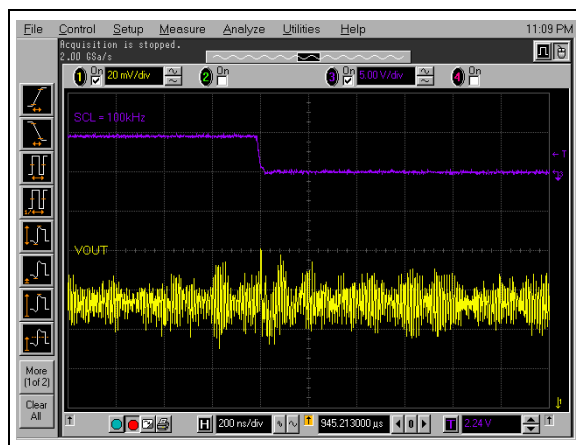
**FIGURE 2-92:** Half-Scale Settling Time (30h to 50h),  $V_{DD} = 5.0\text{V}$ ,  $V_{REF} = 5.0\text{V}$ ,  $R_L = 5\text{k}\Omega$ ,  $C_L = 1\text{nF}$ .



**FIGURE 2-91:** Full-Scale to Zero-Scale Settling Time (60h to 20h),  $V_{DD} = 5.0\text{V}$ ,  $V_{REF} = 5.0\text{V}$ ,  $R_L = 5\text{k}\Omega$ ,  $C_L = 1\text{nF}$ .



**FIGURE 2-93:** Half-Scale Settling Time (50h to 30h),  $V_{DD} = 5.0\text{V}$ ,  $V_{REF} = 5.0\text{V}$ ,  $R_L = 5\text{k}\Omega$ ,  $C_L = 1\text{nF}$ .



**FIGURE 2-94:** Digital Feedthrough (SCL signal coupling to  $V_{OUT}$  pin);  $V_{OUT} = 40\text{h}$ ,  $F_{SCL} = 100\text{kHz}$ ,  $V_{DD} = 5.0\text{V}$ ,  $V_{REF} = 5.0\text{V}$ .

## 3.0 PIN DESCRIPTIONS

The descriptions of the pins are listed in [Table 3-1](#). Additional descriptions of the device pins follow.

**TABLE 3-1: PINOUT DESCRIPTION FOR THE MCP47DA1**

| Pin Name         | Package  |        | Pin Type | Buffer Type | Function                                      |
|------------------|----------|--------|----------|-------------|---|
|                  | SOT-23-6 | SC70-6 |          |             |   |
| V <sub>DD</sub>  | 1        | 1      | P        | —           | Positive Power Supply Input                   |
| V <sub>SS</sub>  | 2        | 2      | P        | —           | Ground  |
| SCL              | 3        | 3      | I/O      | ST (OD)     | I <sup>2</sup> C™ Serial Clock pin            |
| SDA              | 4        | 4      | I/O      | ST (OD)     | I <sup>2</sup> C Serial Data pin              |
| V <sub>OUT</sub> | 5        | 5      | I/O      | A           | Output voltage                                |
| V <sub>REF</sub> | 6        | 6      | I/O      | A           | Reference Voltage for V <sub>OUT</sub> output |

**Legend:** A = Analog input  
I = Input

ST (OD) = Schmitt Trigger with Open Drain  
O = Output

I/O = Input/Output P = Power

### 3.1 Positive Power Supply Input (V<sub>DD</sub>)

The V<sub>DD</sub> pin is the device's positive power supply input. The input power supply is relative to V<sub>SS</sub> and can range from 1.8V to 5.5V. A decoupling capacitor on V<sub>DD</sub> (to V<sub>SS</sub>) is recommended to achieve maximum performance. Analog specifications are tested from 2.7V.

### 3.2 Ground (V<sub>SS</sub>)

The V<sub>SS</sub> pin is the device ground reference.

### 3.3 I<sup>2</sup>C Serial Clock (SCL)

The SCL pin is the serial clock pin of the I<sup>2</sup>C interface. The MCP47DA1 acts only as a slave and the SCL pin accepts only external serial clocks. The SCL pin is an open-drain output. Refer to [Section 5.0 "Serial Interface – I<sup>2</sup>C Module"](#) for more details of I<sup>2</sup>C Serial Interface communication.

### 3.4 I<sup>2</sup>C Serial Data (SDA)

The SDA pin is the serial data pin of the I<sup>2</sup>C interface. The SDA pin has a Schmitt Trigger input and an open-drain output. Refer to [Section 5.0 "Serial Interface – I<sup>2</sup>C Module"](#) for more details of I<sup>2</sup>C Serial Interface communication.

### 3.5 Analog Output Voltage Pin (V<sub>OUT</sub>)

V<sub>OUT</sub> is the DAC analog output pin. The DAC output has an output amplifier.

V<sub>OUT</sub> can swing from approximately V<sub>ZS</sub> = 1/3 \* V<sub>REF</sub> to V<sub>FS</sub> = 2/3 \* V<sub>REF</sub>. In Normal mode, the DC impedance of the output pin is about 1Ω. See [Section 7.0 "Output Buffer"](#) for more information.

### 3.6 Voltage Reference Pin (V<sub>REF</sub>)

This pin is the external voltage reference input. The V<sub>REF</sub> pin signal is unbuffered so the reference voltage must have the current capability not to drop its voltage when connected to the internal resistor ladder circuit (30 kΩ typical). See [Section 6.0 "Resistor Network"](#) for more information.

# MCP47DA1

---

NOTES:

## 4.0 GENERAL OVERVIEW

The MCP47DA1 device is a general purpose DAC intended to be used in applications where a programmable voltage output with moderate bandwidth is desired.

Applications generally suited for the MCP47DA1 devices include:

- Computer servers
- Set point or offset trimming
- Sensor calibration
- Cost-sensitive mechanical trim pot replacement

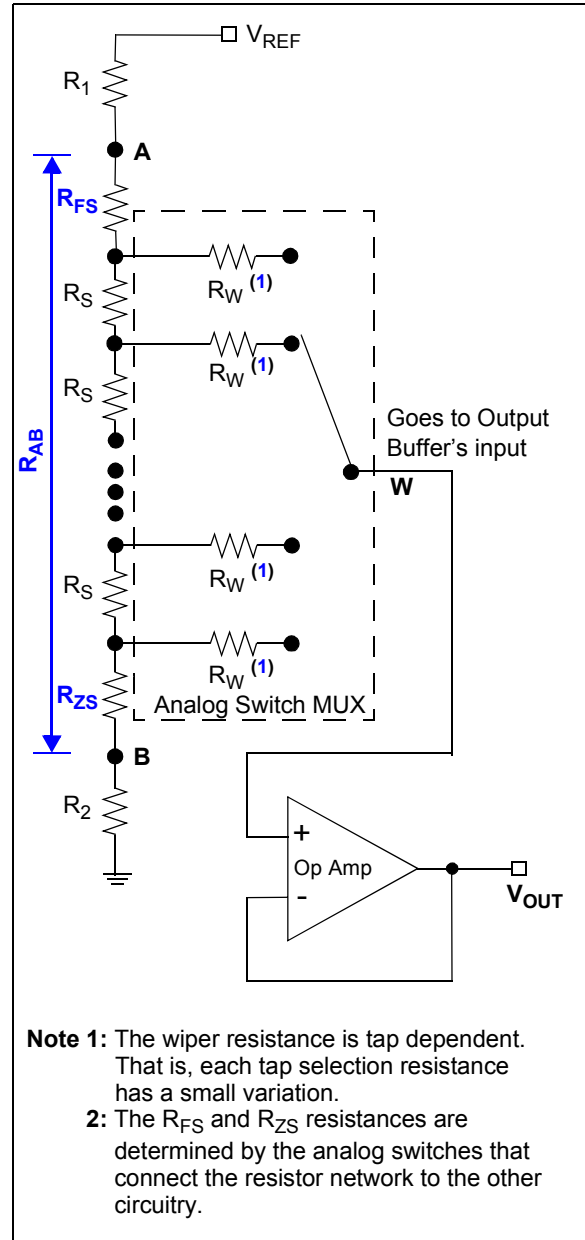
The MCP47DA1 has four main functional blocks. These are:

- **POR/BOR Operation**
- **Serial Interface – I<sup>2</sup>C Module**
- **Resistor Network**
- **Output Buffer**

The POR/BOR operation is discussed in this section and the I<sup>2</sup>C and Resistor Network operation are described in their own sections. The commands are discussed in [Section 5.3, Serial Commands](#).

[Figure 4-1](#) shows a block diagram for the resistive network of the device. An external pin, called  $V_{REF}$ , is the DAC's reference voltage. The resistance from the  $V_{REF}$  pin to ground is typically 30 k $\Omega$ . The reference voltage connected to the  $V_{REF}$  pin needs to support this resistive load.

This resistor network functions as a windowed voltage divider. This means that the  $V_{OUT}$  pin's voltage range is from approximately  $1/3 * V_{REF}$  to approximately  $2/3 * V_{REF}$ . This windowed range is determined by the 10 k $\Omega$  resistors ( $R_1$  and  $R_2$ ) that window the 10 k $\Omega$  digital potentiometer (see [Figure 4-1](#)).



**FIGURE 4-1:** Resistor Network and Output Buffer Block Diagram.

# MCP47DA1

## 4.1 POR/BOR Operation

The Power-on Reset is the case where the device is having power applied to it from  $V_{SS}$ . The Brown-out Reset occurs when a device had power applied to it, and that power (voltage) drops below the specified range.

The device's RAM retention voltage ( $V_{RAM}$ ) is lower than the POR/BOR voltage trip point ( $V_{POR}/V_{BOR}$ ). This ensures that when the device Power-on Reset occurs, the logic can retain the default values that are loaded. The maximum  $V_{POR}/V_{BOR}$  voltage is less than 1.8V. When  $V_{POR}/V_{BOR} < V_{DD} < 2.7V$ , the DACs' electrical performance may not meet the data sheet specifications.

Table 4-2 shows the DAC's level of functionality across the entire  $V_{DD}$  range, while Figure 4-2 illustrates the Power-up and Brown-out functionality.

### 4.1.1 POWER-ON RESET

When the device powers up, the device  $V_{DD}$  will cross the  $V_{POR}/V_{BOR}$  voltage. Once the  $V_{DD}$  voltage crosses the  $V_{POR}/V_{BOR}$  voltage, the following happens:

- Volatile serial shift register/wiper register is loaded with the default values (see Table 4-1)
- The device is capable of digital operation

**Note:** At voltages below  $V_{DD(MIN)}$ , the electrical performance of the I<sup>2</sup>C interface may not meet the data sheet specifications

**TABLE 4-1: DEFAULT POR WIPER SETTING SELECTION**

| Default POR Wiper Setting | Serial Shift Register (SSR) | Wiper Register |
|---------------------------|-----------------------------|----------------|
| Mid-scale                 | 40h                         | 20h            |

**TABLE 4-2: DEVICE FUNCTIONALITY AT EACH  $V_{DD}$  REGION (Note 1)**

| $V_{DD}$ Level               | Serial Interface | $V_{OUT}$  | DAC Register Setting                   | Comment  |
|------------------------------|------------------|--|--|--|
| $V_{DD} < V_{TH}$            | Ignored          | Unknown  | Unknown                                |  |
| $V_{TH} < V_{DD} < V_{BOR}$  | Ignored          | Pulled Low   | Unknown                                |  |
| $V_{BOR} \leq V_{DD} < 1.8V$ | Unknown          | Operational with reduced electrical specifications | DAC register loaded with POR/BOR value |  |
| $1.8V \leq V_{DD} < 2.7V$    | Accepted         | Operational with reduced electrical specifications | DAC register determines serial Value   | Electrical performance may not meet the data sheet specifications. |
| $2.7V \leq V_{DD} \leq 5.5V$ | Accepted         | Operational  | DAC register determines serial value   | Meets the data sheet specifications                                |

**Note 1:** For system voltages below the minimum operating voltage, it is recommended to use a voltage supervisor to hold the system in Reset. This will ensure that MCP47X1 commands are not attempted out of the operating range of the device.

### 4.1.2 BROWN-OUT RESET

When the device powers down, the device  $V_{DD}$  will cross the  $V_{POR}/V_{BOR}$  voltage ( $V_{BOR} < 1.8V$ ). Once the  $V_{DD}$  voltage decreases below the  $V_{POR}/V_{BOR}$  voltage, the following happens:

- Serial Interface is disabled

If the  $V_{DD}$  voltage decreases below the  $V_{RAM}$  voltage, the following happens:

- Volatile Serial Shift Register (SSR) and wiper register may become corrupted

As the voltage recovers above the  $V_{POR}/V_{BOR}$  voltage, see Section 4.1.1 "Power-on Reset".

Serial commands not completed due to a brown-out condition may cause the memory location to become corrupted.

### 4.1.3 WIPER REGISTER (RAM)

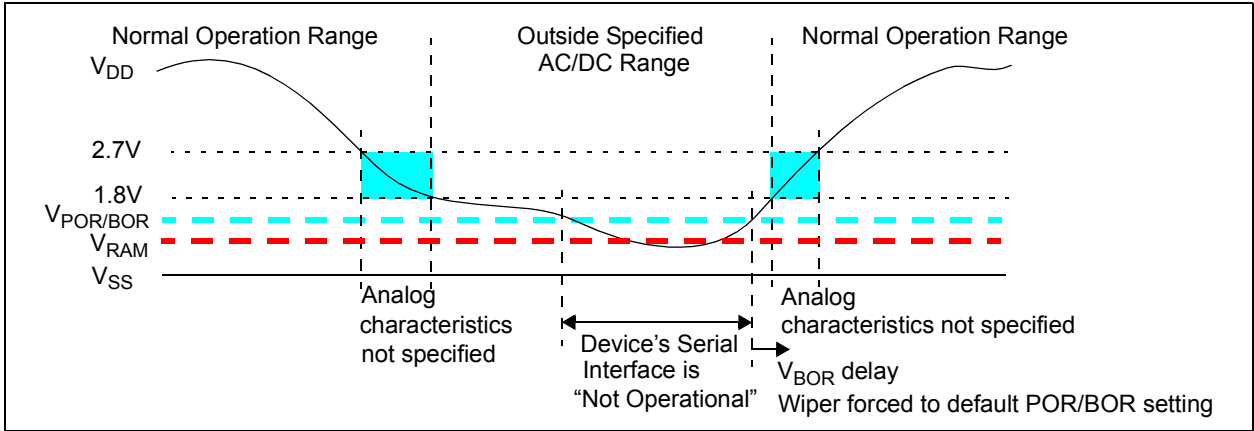
The wiper register is 7-bit volatile memory that starts functioning at the RAM retention voltage ( $V_{RAM}$ ). The wiper register will be loaded with the default wiper value when  $V_{DD}$  rises above the  $V_{POR}/V_{BOR}$  voltage.

### 4.1.4 DEVICE CURRENTS

The current of the device can be classified into two modes of the device operation. These are:

- Serial Interface Inactive (Static Operation)
- Serial Interface Active

Static Operation occurs when a Stop condition is received. Static Operation is exited when a Start condition is received.



**FIGURE 4-2:** Power-up and Brown-out.

# MCP47DA1

---

NOTES:



## 5.0 SERIAL INTERFACE – I<sup>2</sup>C MODULE

A 2-wire I<sup>2</sup>C serial protocol is used to write or read the DAC's wiper register. The I<sup>2</sup>C protocol utilizes the SCL input pin and SDA input/output pin.

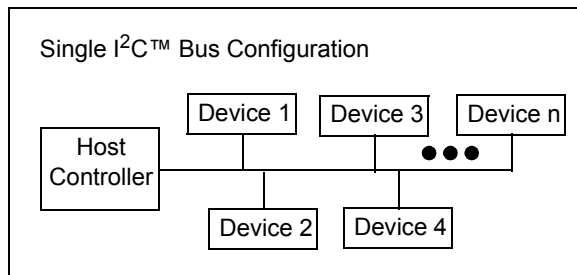
The I<sup>2</sup>C serial interface supports the following features:

- Slave mode of operation
- 7-bit addressing
- The following clock rate modes are supported:
  - Standard mode, bit rates up to 100 kb/s
  - Fast mode, bit rates up to 400 kb/s
- Support multi-master applications

The serial clock is generated by the master.

The I<sup>2</sup>C module is compatible with the NXP I<sup>2</sup>C specification (UM10204). Only the field types, field lengths, timings, etc. of a frame are defined. The frame *content* defines the behavior of the device. The frame content for the MCP47DA1 device is defined in this section of the data sheet.

Figure 5-1 shows a typical I<sup>2</sup>C bus configuration.



**FIGURE 5-1:** Typical Application I<sup>2</sup>C Bus Configurations.

Refer to [Section 2.0 “Typical Performance Curves”](#), AC/DC Electrical Characteristics table for detailed input threshold and timing specifications.

## 5.1 I<sup>2</sup>C I/O Considerations

I<sup>2</sup>C specifications require active-low, passive-high functionality on devices interfacing to the bus. Since devices may be operating on separate power supply sources, ESD clamping diodes are not permitted. The specification recommends using open drain transistors tied to V<sub>SS</sub> (common) with a pull-up resistor. The specification makes some general recommendations on the size of this pull-up, but does not specify the exact value since bus speeds and bus capacitance impact the pull-up value for optimum system performance.

Common pull-up values range from 1 kΩ to a maximum of ~10 kΩ. Power sensitive applications tend to choose higher values to minimize current losses during communication but these applications also typically utilize lower V<sub>DD</sub>.

The SDA and SCL float (are not driving) when the device is powered down.

A “glitch” filter is on the SCL and SDA pins when the pin is an input. When these pins are an output, there is a slew rate control of the pin that is independent of device frequency.

### 5.1.1 SLOPE CONTROL

The device implements slope control on the SDA output. The slope control is defined by the Fast mode specifications.

For Fast (FS) mode, the device has spike suppression and Schmitt Trigger inputs on the SDA and SCL pins.

# MCP47DA1

## 5.2 I<sup>2</sup>C Bit Definitions

I<sup>2</sup>C bit definitions include:

- Start Bit
- Data Bit
- Acknowledge (A) Bit
- Repeated Start Bit
- Stop Bit
- Clock Stretching

Figure 5-8 shows the waveform for these states.

### 5.2.1 START BIT

The Start bit (see Figure 5-2) indicates the beginning of a data transfer sequence. The Start bit is defined as the SDA signal falling when the SCL signal is “High”.

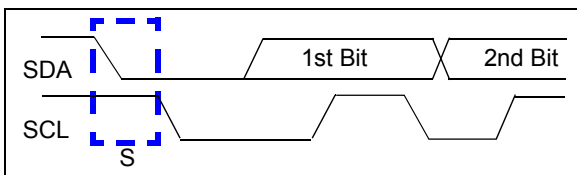


FIGURE 5-2: Start Bit.

### 5.2.2 DATA BIT

The SDA signal may change state while the SCL signal is Low. While the SCL signal is High, the SDA signal MUST be stable (see Figure 5-3).

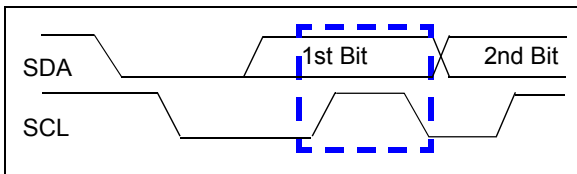


FIGURE 5-3: Data Bit.

### 5.2.3 ACKNOWLEDGE (A) BIT

The A bit (see Figure 5-4) is a response from the slave device to the master device. Depending on the context of the transfer sequence, the A bit may indicate different things. Typically the slave device will supply an A response after the Start bit and eight “data” bits have been received. The A bit will have the SDA signal low.

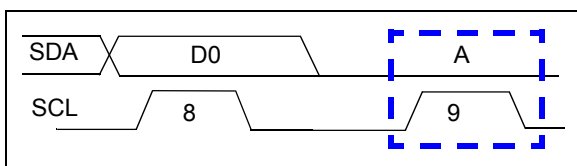


FIGURE 5-4: Acknowledge Waveform.

If the slave address is not valid, the slave device will issue a Not A ( $\bar{A}$ ). The  $\bar{A}$  bit will have the SDA signal high.

If an error condition occurs (such as an  $\bar{A}$  instead of A) then a Start bit must be issued to reset the command state machine.

TABLE 5-1: MCP47DA1  $\bar{A}/A$  RESPONSES

| Event                   | Acknowledge Bit Response | Comment   |
|-------------------------|--------------------------|---|
| General Call            | $\bar{A}$                |   |
| Slave Address valid     | A                        |   |
| Slave Address not valid | $\bar{A}$                |   |
| Bus Collision           | N.A.                     | I <sup>2</sup> C module resets, or a “Don’t Care” if the collision occurs on the masters “Start bit”. |

### 5.2.4 REPEATED START BIT

The Repeated Start bit (see Figure 5-5) indicates the current master device wishes to continue communicating with the current slave device without releasing the I<sup>2</sup>C bus. The Repeated Start condition is the same as the Start condition, except that the Repeated Start bit follows a Start bit (with the data bits + A bit) and not a Stop bit.

The Start bit is the beginning of a data transfer sequence and is defined as the SDA signal falling when the SCL signal is “High”.

**Note 1:** A bus collision during the Repeated Start condition occurs if:

- SDA is sampled low when SCL goes from low to high.
- SCL goes low before SDA is asserted low. This may indicate that another master is attempting to transmit a data ‘1’.

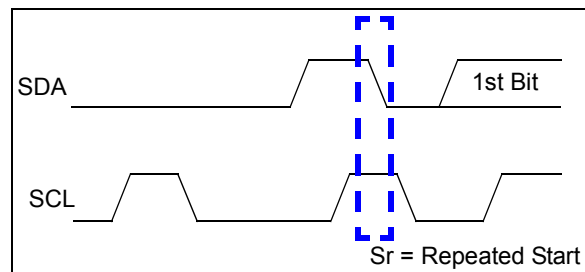
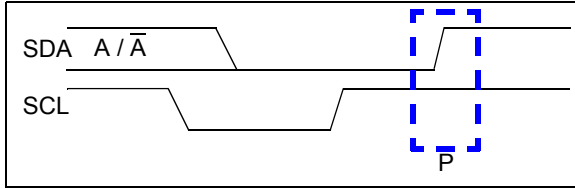


FIGURE 5-5: Repeat Start Condition Waveform.

## 5.2.5 STOP BIT

The Stop bit (see [Figure 5-6](#)) indicates the end of the I<sup>2</sup>C data transfer sequence. The Stop bit is defined as the SDA signal rising when the SCL signal is “High”.

A Stop bit resets the I<sup>2</sup>C interface of the other devices.



**FIGURE 5-6:** Stop Condition Receive or Transmit Mode.

## 5.2.6 CLOCK STRETCHING

“Clock Stretching” is something that the secondary device can do, to allow additional time to “respond” to the “data” that has been received.

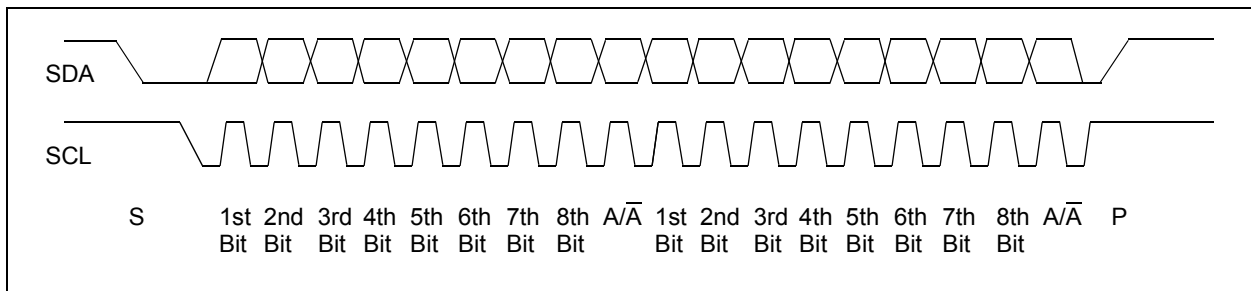
The MCP47DA1 will not stretch the clock signal (SCL) since memory read accesses occur fast enough.

## 5.2.7 ABORTING A TRANSMISSION

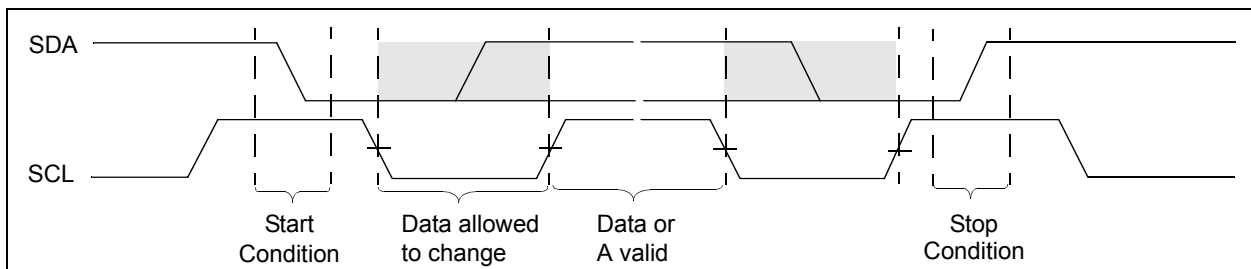
If any part of the I<sup>2</sup>C transmission does not meet the command format, it is aborted. This can be intentionally accomplished with a Start or Stop condition. This is done so that noisy transmissions (usually an extra Start or Stop condition) are aborted before they corrupt the device.

## 5.2.8 IGNORING AN I<sup>2</sup>C TRANSMISSION AND “FALLING OFF” THE BUS

The MCP47DA1 expects to receive entire, valid I<sup>2</sup>C commands and will assume any command not defined as a valid command is due to a bus corruption, and will enter a passive high condition on the SDA signal. All signals will be ignored until the next valid Start condition and control byte are received.



**FIGURE 5-7:** Typical 16-bit I<sup>2</sup>C Waveform Format.



**FIGURE 5-8:** I<sup>2</sup>C Data States and Bit Sequence.

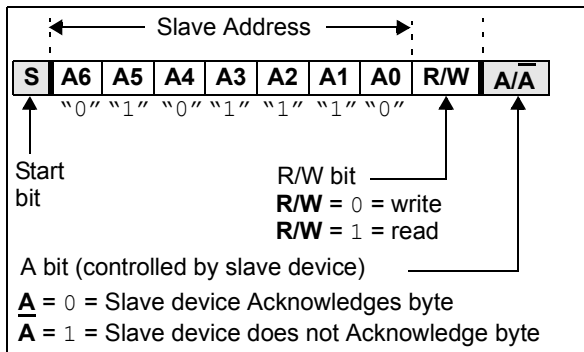
# MCP47DA1

## 5.2.9 I<sup>2</sup>C COMMAND PROTOCOL

The MCP47DA1 is a slave I<sup>2</sup>C device which supports 7-bit slave addressing. The slave address contains seven fixed bits. Figure 5-9 shows the control byte format.

### 5.2.9.1 Control Byte (Slave Address)

The control byte is always preceded by a Start condition. The control byte contains the slave address consisting of seven fixed bits and the R/W bit. Figure 5-9 shows the control byte format and Table 5-2 shows the I<sup>2</sup>C address for the devices.



**FIGURE 5-9:** Slave Address Bits in the I<sup>2</sup>C Control Byte.

**TABLE 5-2: DEVICE I<sup>2</sup>C ADDRESS**

| Device   | I <sup>2</sup> C™ Address |                    |      | Comment |
|----------|---------------------------|--------------------|------|---------|
|          | Binary                    | Hex <sup>(1)</sup> | Code |         |
| MCP47DA1 | '0101110'                 | 0x5C               | A0   |         |
|          | '0111110'                 | 0x7C               | A1   |         |

**Note 1:** The LSb of the 8-bit hex code is the I<sup>2</sup>C Read/Write (R/W) bit. This hex value has a R/W bit = "0" (write). If the R/W bit reflected a read, this values would be 0x5D and 0x7D.

**Note 1:** The MCP47DA1 device supports two different I<sup>2</sup>C address (A0 and A1). This allows two MCP47DA1 device on the same I<sup>2</sup>C bus.

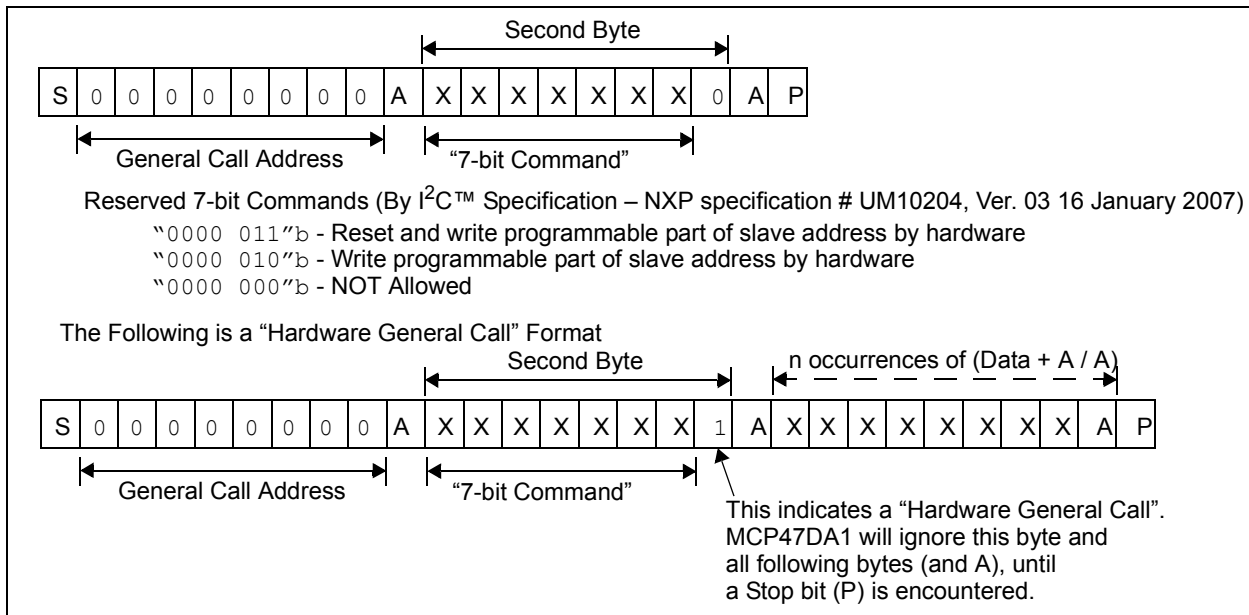
### 5.2.9.2 Hardware Address Pins

The MCP47DA1 does not support hardware address bits.

### 5.2.10 GENERAL CALL

The General Call is a method that the master device can communicate with all other slave devices.

The MCP47DA1 devices do not respond to General Call address and commands, and therefore the communications are Not Acknowledged.



**FIGURE 5-10:** General Call Formats.

## 5.3 Serial Commands

The MCP47DA1 devices support two serial commands. These commands are:

- **Write Operation**
- **Read Operation**

The I<sup>2</sup>C command formats have been defined to support the SMBus version 2.0 Write Byte/Word Protocol formats and Read Byte/Word Protocol formats. The SMBus specification that defines this operation is Section 5 of the Version 2.0 document (August 3, 2000).

This protocol format may be convenient for customers using library routines for the I<sup>2</sup>C bus, where all they need to do is specify the command (Read, Write, ...) with the device address, the register address, and the data.

### 5.3.1 WRITE OPERATION

The write operation requires the Start condition, control byte, acknowledge, command code, acknowledge, data byte, acknowledge and Stop (or Restart) condition. The control (slave address) byte requires the R/W bit equal to a logic zero ( $R/\overline{W} = 0$ ) to generate a write sequence. The MCP47DA1 is responsible for generating the Acknowledge (A) bits.

Data is written to the MCP47DA1 after every byte transfer (during the A bit). If a Stop or Restart condition is generated during a data transfer (before the A bit), the data will not be written to MCP47DA1.

Data bytes may be written after each Acknowledge. The command is terminated once a Stop (P) condition occurs. Refer to [Figure 5-11](#) for the single byte write sequence and [Figure 5-12](#) for the generic (multi-byte) write sequence. For a single byte write, the master sends a Stop or Restart condition after the first data byte is sent.

The MSb of each data byte is a “Don’t Care”, since the wiper register is only 7-bits wide.

The command is terminated once a Stop (P) or Restart (S) condition occurs.

[Figure 5-13](#) shows the I<sup>2</sup>C write communication behavior of the master device and the MCP47DA1 device and the resultant I<sup>2</sup>C bus values.

**Note:** A command code with a non-zero value will cause the data not to be written to the wiper register

### 5.3.2 READ OPERATION

The read operation requires the Start condition, control byte, acknowledge, command code, acknowledge, Restart condition, control byte, acknowledge, data byte, the master generating the A and Stop (or Restart) condition. The first control byte requires the R/W bit equal to a logic zero ( $R/\overline{W} = 0$ ) to write the command code, while the second control byte requires the R/W bit equal to a logic one ( $R/\overline{W} = 1$ ) to generate a read sequence. The MCP47DA1 will A the slave address byte and A all the data bytes. The I<sup>2</sup>C master will A the slave address byte and the last data byte. If there are multiple data bytes, the I<sup>2</sup>C master will A all data bytes except the last data byte (which it will A).

The MCP47DA1 maintains control of the SDA signal until all data bits have been clocked out.

The command is terminated once a Stop (P) or Restart (S) condition occurs. Refer to [Figure 5-14](#) for the read command sequence. For a single read, the master sends a Stop or Restart condition after the first data byte (and A bit) is sent from the slave.

The MSb of each data byte is always a ‘0’, since the wiper register is only 7-bits wide.

[Figure 5-15](#) shows the I<sup>2</sup>C read communication behavior of the master device and the MCP47DA1 device and the resultant I<sup>2</sup>C bus values.

**Note:** A command code with a non-zero value will cause the data not to be read from the wiper register

# MCP47DA1

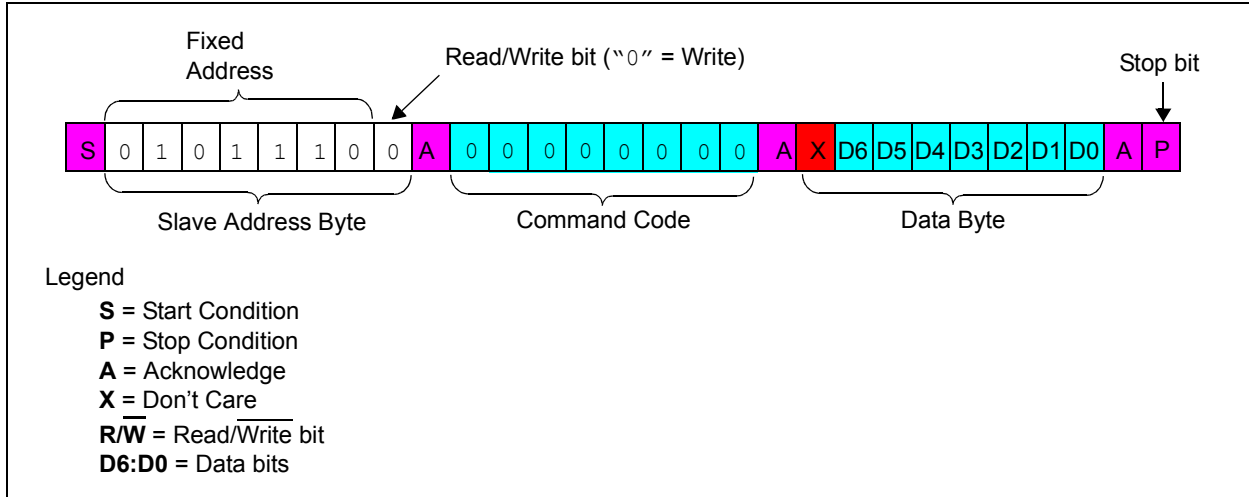


FIGURE 5-11: I<sup>2</sup>C Single Byte Write Command Format.

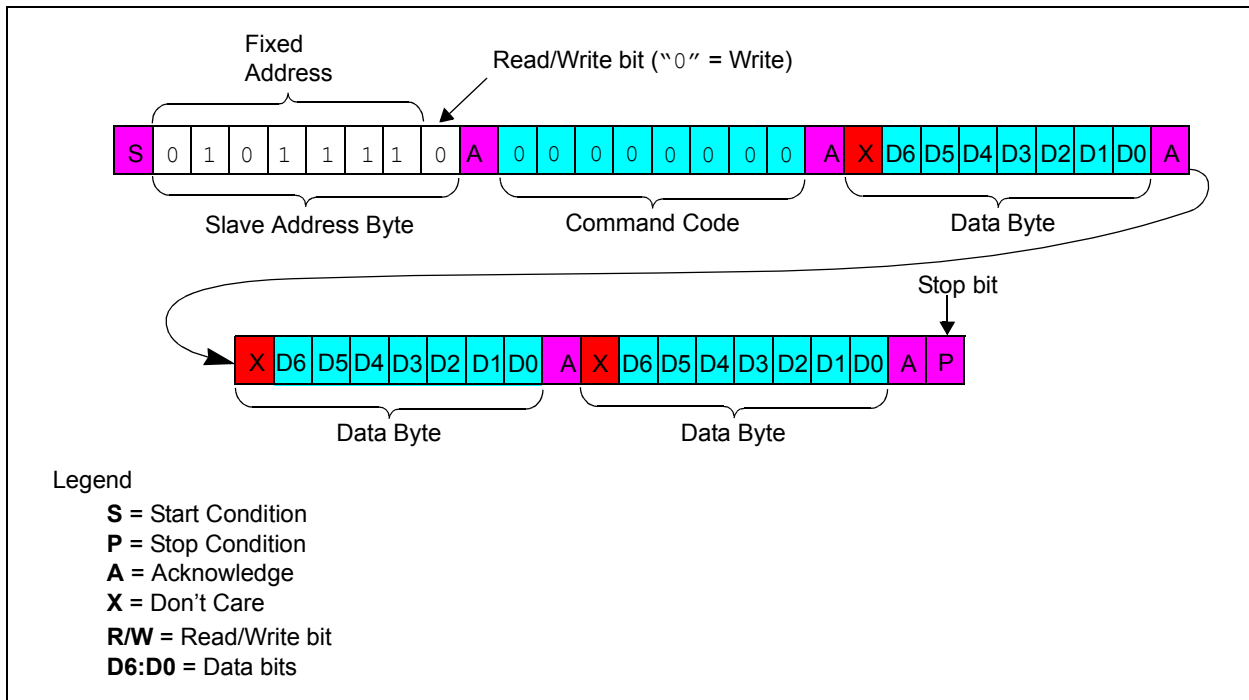
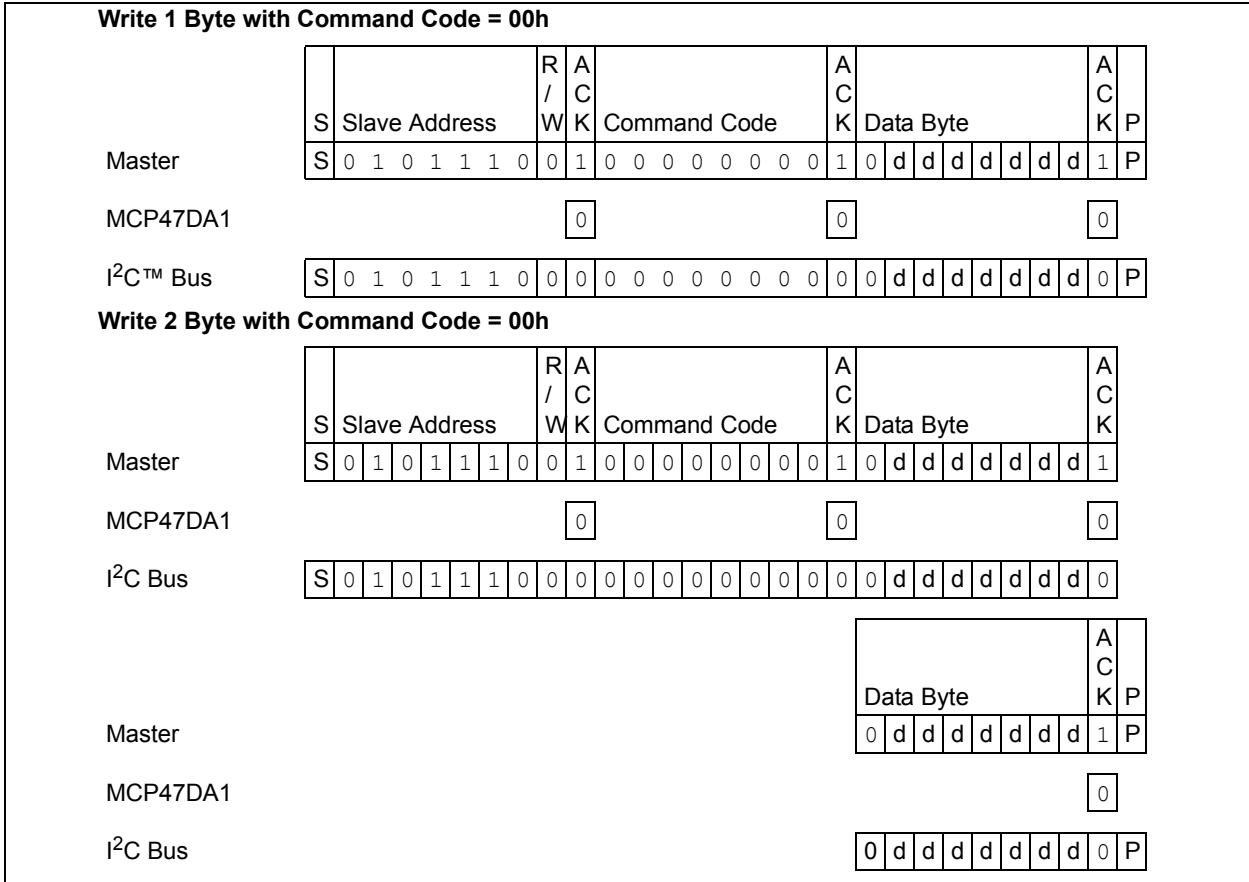


FIGURE 5-12: I<sup>2</sup>C Write Command Format.



**FIGURE 5-13:** I<sup>2</sup>C Write Communication Behavior.

# MCP47DA1

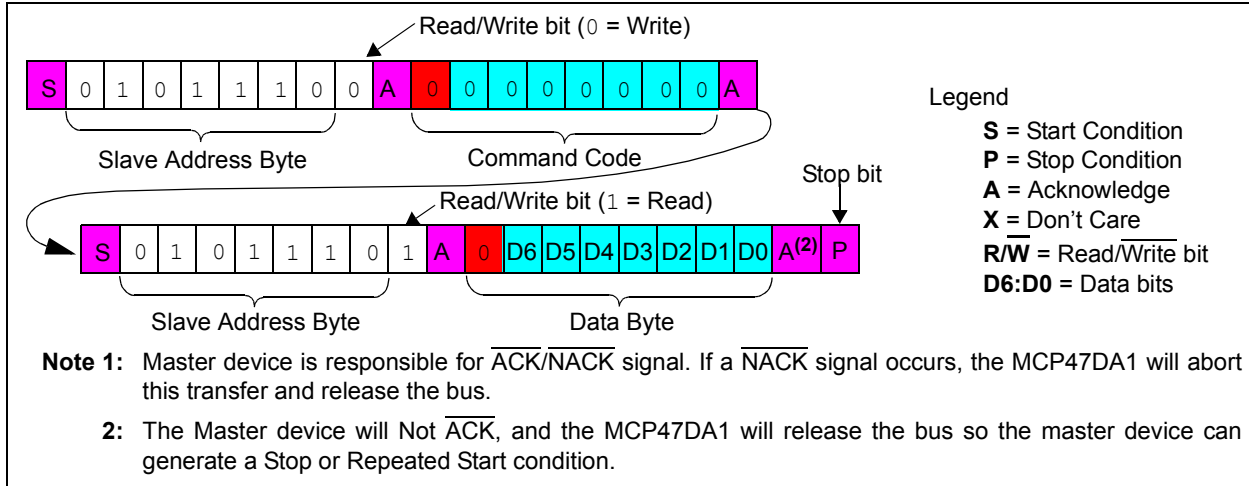


FIGURE 5-14: I<sup>2</sup>C Read Command Format.

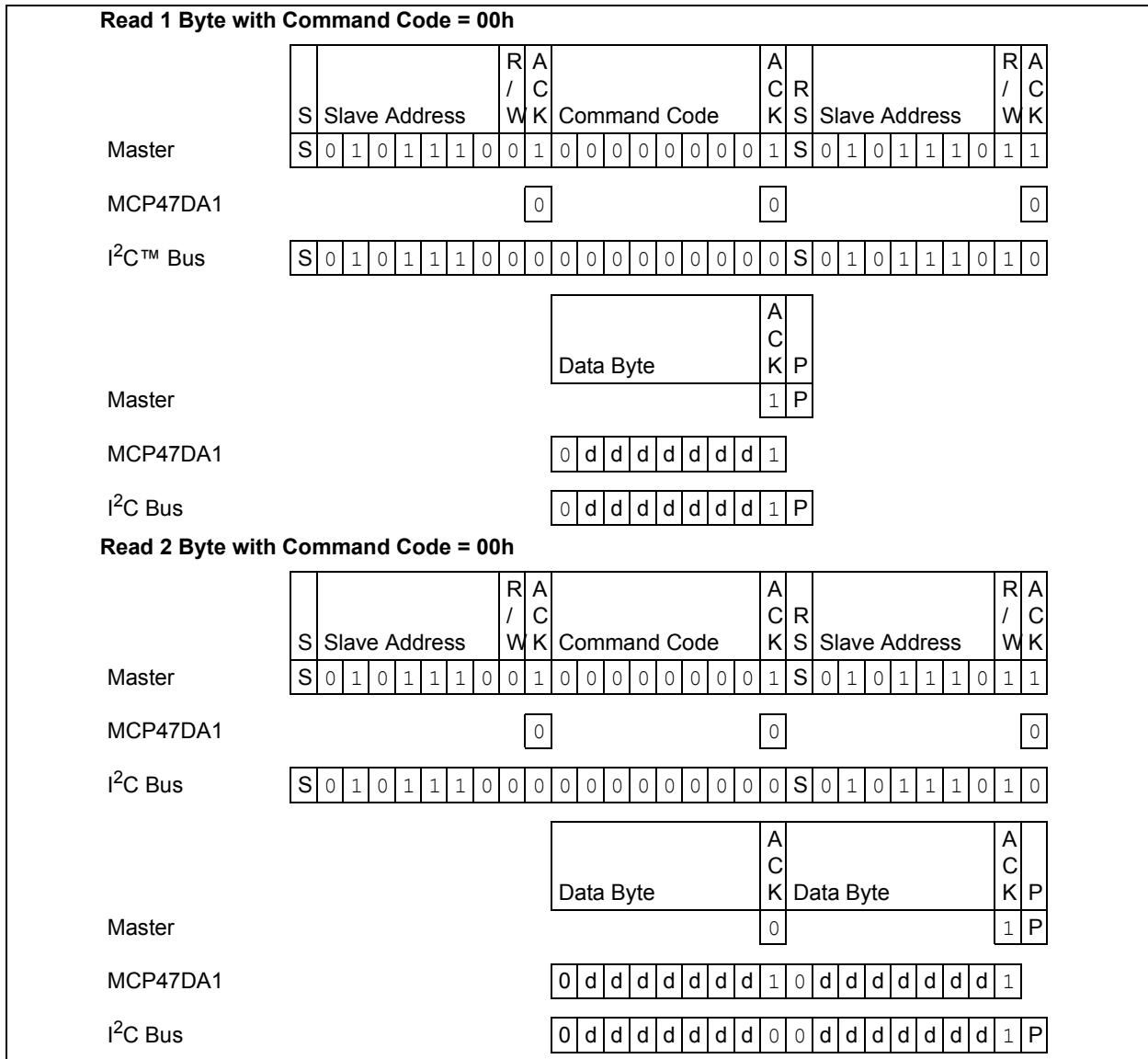


FIGURE 5-15: I<sup>2</sup>C Read Communication Behavior.



## 6.0 RESISTOR NETWORK

The Resistor Network is made up of an  $R_1$  resistor, an  $R_{AB}$  resistor ladder, and an  $R_2$  resistor connected together. These three resistors are equal ( $R_1 = R_{AB} = R_2$ ) each with a typical resistance of  $10k\Omega$ . The  $R_1$  resistor is also connected to the external  $V_{REF}$  pin while the  $R_2$  resistor is also internally connected to ground. [Figure 6-1](#) shows a block diagram for the resistor network and output buffer. The resistance from the  $V_{REF}$  pin to ground is referred to as  $R_{VREF}$ .

The 7-bit I<sup>2</sup>C data byte (00h-7Fh) is decoded to the 6-bit wiper value (00h-40h). [Section 6.4](#) describes the serial shift buffer to wiper register decoding.

### 6.1 $R_{VREF}$ Resistance

$R_{VREF}$  resistance is the resistance from the  $V_{REF}$  pin to ground and is the sum of the  $R_1$ ,  $R_{AB}$ , and  $R_2$  resistances. [Equation 6-1](#) shows how to calculate  $R_{VREF}$ .

#### 6.1.1 $V_{REF}$ PIN CURRENT ( $I_{VREF}$ )

The current into the  $V_{REF}$  pin is dependent on the voltage on the  $V_{REF}$  pin ( $V_{REF}$ ) and the  $R_{VREF}$  resistance. The  $V_{REF}$  pin's voltage source current capability should support a resistive load that is the minimum  $R_{VREF}$  resistance.

#### EQUATION 6-1: CALCULATING $R_{VREF}$

$$R_{VREF} = \frac{V_{REF}}{I_{VREF}}$$

$V_{REF}$  is the voltage on the  $V_{REF}$  pin.  
 $I_{VREF}$  is the current into the  $V_{REF}$  pin.

### 6.2 $R_1$ and $R_2$ Fixed Resistors

The  $R_1$  and  $R_2$  resistors are implemented so that based on temperature and process variations, these resistors track the  $R_{AB}$  resistor ladder. The typical  $R_1$  and  $R_2$  resistances are  $10k\Omega$ .

## 6.3 $R_{AB}$ Resistor Ladder

The  $R_{AB}$  resistor ladder is a digital potentiometer in a voltage divider configuration. The  $R_{AB}$  resistor ladder has 64  $R_S$  resistors in series. This resistor ladder has 65 wiper taps which allow wiper connectivity to the bottom (terminal B), Zero Scale, and the top (terminal A), Full Scale, of the resistor ladder (see [Figure 6-1](#)). With an even number of  $R_S$  resistors in the  $R_{AB}$  ladder, when the wiper is at the mid-scale value,  $V_{OUT}$  equals  $V_{REF}/2$ . The  $R_{AB}$  resistance also includes the  $R_{FS}$  and  $R_{ZS}$  resistances (see [Section 6.3.2](#)). The  $R_{AB}$  (and  $R_S$ ) resistance has small variations over voltage and temperature. The typical  $R_{AB}$  resistance is  $10k\Omega$ .

### 6.3.1 THE WIPER

The value in the volatile wiper register selects which analog switch to close, connecting the W terminal to the selected node of the resistor ladder. The wiper register value is derived from the SSR value (see [Section 6.4](#)).

Any variation of the wiper resistance does not effect the voltage at the W terminal, and therefore the input of the output buffer.

### 6.3.2 $R_{FS}$ AND $R_{ZS}$ RESISTORS

The  $R_{FS}$  and  $R_{ZS}$  resistances are artifacts of the  $R_{AB}$  resistor implementation. These resistors are included in the block diagram to help better model the actual device operation. [Equation 6-2](#) shows how to estimate the  $R_S$ ,  $R_{FS}$ , and  $R_{ZS}$  resistances, based on the measured voltages of  $V_{REF}$ ,  $V_{FS}$ , and  $V_{ZS}$  and the measured current  $I_{VREF}$ .

#### EQUATION 6-2: ESTIMATING $R_S$ , $R_{FS}$ , AND $R_{ZS}$

$$R_{FS} = \frac{((V_{REF} - (64 * V_S)) - V_{FS})}{I_{VREF}}$$

$$R_{ZS} = \frac{(V_{ZS} - (64 * V_S))}{I_{VREF}}$$

$$R_S = \frac{V_S}{I_{VREF}}$$

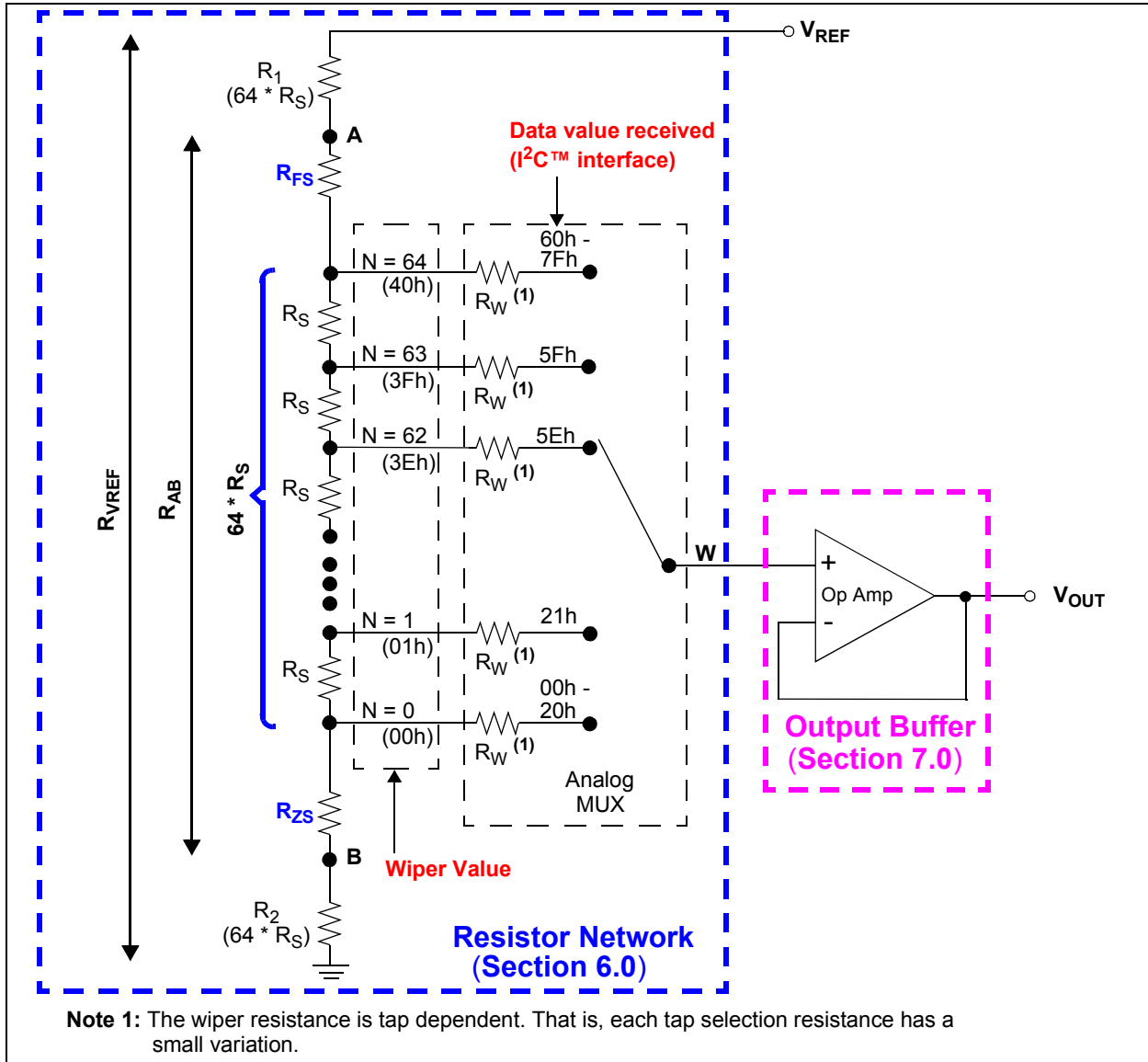
Where:

$$V_S = \frac{(V_{FS} - V_{ZS})}{64}$$

$V_{FS}$  is the  $V_{OUT}$  voltage when the wiper code is at full scale (SSR = 60h through 7Fh).

$V_{ZS}$  is the  $V_{OUT}$  voltage when the wiper code is at zero scale (SSR = 00h through 20h).

# MCP47DA1



**FIGURE 6-1:** Resistor Network and Output Buffer Block Diagram.

## 6.4 Serial Buffer to Wiper Register Decode

The I<sup>2</sup>C's data byte is 8-bits, where only the lower 7-bits are implemented. This register is called the Serial Shift Register (SSR). The wiper register supports addressing of 65 taps (6-bit resolution). This 6-bit resolution is centered about the 7-bit range (where 40h is mid-scale). So, SSR values 20h and below are zero-scale values, and SSR values 60h and above are full-scale values. Table 6-1 shows the decoding of the serial shift register to the wiper register value.

- Note 1:** The I<sup>2</sup>C Write and Read commands access the value in the Serial Shift Register (SSR).
- 2:** The MSb of the I<sup>2</sup>C data byte is ignored and not loaded into the SSR. A write of C0h, will result in the same V<sub>OUT</sub> voltage as a write of 40h (mid-scale). A subsequent Read command (of the SSR) will result in a value of 40h.
- 3:** The 7-bit SSR value is decoded to a 6-bit (65 taps) value that controls the wiper's position.

**TABLE 6-1: SERIAL SHIFT REGISTER VALUE TO WIPER VALUE**

| I <sup>2</sup> C™ Write Data | SSR <sup>(1)</sup> | Wiper Value <sup>(2)</sup> | Comment   |
|------------------------------|--------------------|----------------------------|---|
| 00h - 20h or 80h - A0h       | 00h - 20h          | 00h                        | Wiper register at Zero Scale, V <sub>OUT</sub> = (1/3) * V <sub>REF</sub> |
| 21h or A1h                   | 21h                | 01h                        | Wiper register = SSR - 20h  |
| 22h or A2h                   | 22h                | 02h                        | Wiper register = SSR - 20h  |
|                              | :                  | :                          | :   |
| 40h or C0h                   | 40h                | 20h                        | Mid-Scale (POR value), V <sub>OUT</sub> = (1/2) * V <sub>REF</sub>        |
|                              | :                  | :                          | :   |
| 5Eh or DEh                   | 5Eh                | 3Eh                        | Wiper register = SSR - 20h  |
| 5Fh or DFh                   | 5Fh                | 3Fh                        | Wiper register = SSR - 20h  |
| 60h - 7Fh or E0h - FFh       | 60h - 7Fh          | 40h                        | Wiper register at Full Scale, V <sub>OUT</sub> = (2/3) * V <sub>REF</sub> |

- Note 1:** The Serial Shift Register (SSR) is 7-bits wide and holds the value written from the I<sup>2</sup>C Write command. An I<sup>2</sup>C Read command will read the value in this register.
- 2:** The wiper value is the value that controls the resistor ladder's wiper position.

## 6.5 Resistor Variations (Voltage and Temperature)

The R<sub>1</sub>, R<sub>AB</sub>, and R<sub>2</sub> resistors are implemented to have minimal variations (by design). Any variations should occur uniformly on all the resistor elements, so the resistor's elements will track each other over temperature and process variations.

The variation of the resistive elements over the operating voltage range is also minimal. Therefore the V<sub>REF</sub> resistance (R<sub>VREF</sub>) of the device has minimal variation due to operating voltage.

Since the V<sub>OUT</sub> pin's voltage is ratiometric, the resistive elements change uniformly over temperature, process, and operating voltage variations. Minimal variation should be seen on the V<sub>OUT</sub> pin's voltage.

## 6.6 POR Value

A POR/BOR event will load the volatile serial shift register (and therefore wiper register) with the default value. Table 6-2 shows the default values offered.

**TABLE 6-2: POR/BOR SETTINGS**

| Device   | Setting   | Register Value <sup>(1)</sup> |       |
|----------|-----------|-------------------------------|-------|
|          |           | SSR                           | Wiper |
| MCP47DA1 | Mid-scale | 40h                           | 20h   |

- Note 1:** Custom POR/BOR wiper setting options are available; contact the local Microchip Sales Office for additional information. Custom options have NRE and minimum volume requirements.

# MCP47DA1

---

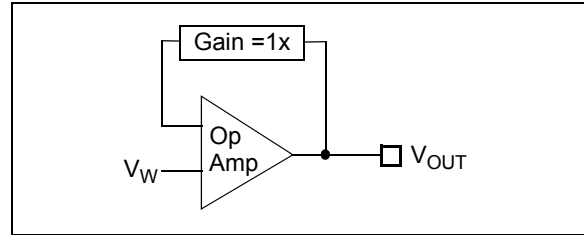
NOTES:

## 7.0 OUTPUT BUFFER

As the device powers up, the  $V_{OUT}$  pin will float to an unknown value. When the device's  $V_{DD}$  is above the transistor threshold voltage of the device, the output will start being pulled low. After the  $V_{DD}$  is above the POR/BOR trip point ( $V_{BOR}/V_{POR}$ ), the resistor network's wiper will be loaded with the POR value (40h, which is mid-scale). The input voltage to the buffer will be the  $V_{REF}/2$ . The output voltage of the buffer ( $V_{OUT}$ ) may not be within specification until the device  $V_{DD}$  is at the minimum operating voltage (2.7V). The outputs' slew rate and settling time must also be taken into account.

### 7.1 Output Buffer/ $V_{OUT}$ Operation

The DAC output is buffered with a low power and precision output amplifier (op amp). This amplifier provides a rail-to-rail output with low offset voltage and low noise. The amplifier's output can drive the resistive and capacitive loads without oscillation. The amplifier provides a maximum load current which is enough for most programmable voltage reference applications. Figure 7-1 shows a block diagram.



**FIGURE 7-1:** Output Buffer Block Diagram.

#### 7.1.1 OUTPUT VOLTAGE

The volatile DAC register's value controls the analog  $V_{OUT}$  voltage. The volatile wiper register's value is unsigned binary. The formula for the output voltage is given in Equation 7-1.

#### EQUATION 7-1: CALCULATING OUTPUT VOLTAGE ( $V_{OUT}$ )

$$V_{OUT} = V_{ZS} + (N * V_S)$$

$$\text{When } R_{FS} = R_{ZS} = 0\Omega : V_{ZS} = \frac{V_{REF}}{3}$$

$V_{ZS}$  is the  $V_{OUT}$  voltage when the wiper code = 00h.  
 $N$  = wiper code = 0 to 64;

**Note 1:** The load resistance must stay higher than 5 k $\Omega$  for the stable and expected analog output (to meet electrical specifications). Refer to:

- [Section 1.0 "Electrical Characteristics"](#) for the specifications of the output amplifier.
- [Section 7.3 "Driving Resistive and Capacitive Loads"](#) for additional design information.

**2:** The output amplifier's input is not rail-to-rail, and requires a 1.0V delta to the  $V_{DD}$  voltage to ensure output linearity.

This is not an issue for most voltages, since the maximum voltage on the amplifier input is the Full-Scale voltage ( $V_{FS}$ ).  $V_{FS} = 2/3 * V_{REF}$ . But when the  $V_{DD}$  (=  $V_{REF}$ ) voltage is lower than 3.0V, the delta voltage is less than 1.0V and the amplifier will not be in the linear region for the codes near the full-scale value.

For device  $V_{DD}$  voltages  $\geq 3.0V$ , the  $V_{REF}$  pin can be tied to  $V_{DD}$ . For  $V_{DD}$  voltages  $< 3.0V$ , the maximum  $V_{REF}$  voltage is:

$$(V_{DD} - 1.0V) / (2/3)$$

The serial shift register's value will be latched on the falling edge of the acknowledge pulse of the Write command's last byte. Then the  $V_{OUT}$  voltage will start driving to the new value.

The following events update the analog voltage output ( $V_{OUT}$ ):

- Power-On-Reset.
- Falling edge of the acknowledge pulse of the last Write command byte.

#### 7.1.2 STEP VOLTAGE ( $V_S$ )

The Step voltage is dependent on the device resolution (64  $R_S$ ) and the output voltage range ( $V_{ZS}$  to  $V_{FS}$ ). Equation 7-2 shows the calculation for the step resistance.

#### EQUATION 7-2: $V_S$ CALCULATION

$$V_S = \frac{(V_{FS} - V_{ZS})}{64}$$

$V_{FS}$  is the  $V_{OUT}$  voltage when the wiper code is at full scale (SSR = 60h through 7Fh).

$V_{ZS}$  is the  $V_{OUT}$  voltage when the wiper code is at zero scale (SSR = 00h through 20h).

Table 7-1 shows the calculated  $V_{OUT}$  voltages for the given volatile wiper register value. These calculations are based on different  $V_{REF}$  voltage values (1.5V, 3.3V, and 5.0V) with an assumption that  $R_{FS} = R_{ZS} = 0\Omega$ .

# MCP47DA1

TABLE 7-1: THEORETICAL DAC OUTPUT VALUES (WIPER VALUE = I<sup>2</sup>C WRITE DATA - 20H)

| Wiper Value<br>(Note 1) |     | SSR Value | V <sub>OUT</sub> (2) |                  |        |        |
|-------------------------|-----|-----------|----------------------|------------------|--------|--------|
| Hex                     | Dec |           | Ratio                | V <sub>REF</sub> |        |        |
|                         |     |           |                      | 1.5              | 3.3    | 5.0    |
| 00h                     | 0   | 20h       | 0.3333               | 0.5000           | 1.1000 | 1.6667 |
| 01h                     | 1   | 21h       | 0.3385               | 0.0578           | 1.1172 | 1.6927 |
| 02h                     | 2   | 22h       | 0.3438               | 0.5156           | 1.1344 | 1.7188 |
| 03h                     | 3   | 23h       | 0.3490               | 0.5234           | 1.1516 | 1.7448 |
| 04h                     | 4   | 24h       | 0.3542               | 0.5313           | 1.1688 | 1.7711 |
| 05h                     | 5   | 25h       | 0.3594               | 0.5391           | 1.1859 | 1.7969 |
| 06h                     | 6   | 26h       | 0.3646               | 0.5469           | 1.2031 | 1.8229 |
| 07h                     | 7   | 27h       | 0.3698               | 0.5547           | 1.2203 | 1.8490 |
| 08h                     | 8   | 28h       | 0.3750               | 0.5625           | 1.2375 | 1.8750 |
| 09h                     | 9   | 29h       | 0.3802               | 0.5703           | 1.2547 | 1.9010 |
| 0Ah                     | 10  | 2Ah       | 0.3854               | 0.5781           | 1.2719 | 1.9271 |
| 0Bh                     | 11  | 2Bh       | 0.3906               | 0.5859           | 1.2891 | 1.9531 |
| 0Ch                     | 12  | 2Ch       | 0.3958               | 0.5938           | 1.3063 | 1.9792 |
| 0Dh                     | 13  | 2Dh       | 0.4010               | 0.6016           | 1.3234 | 2.0052 |
| 0Eh                     | 14  | 2Eh       | 0.4063               | 0.6094           | 1.3406 | 2.0313 |
| 0Fh                     | 15  | 2Fh       | 0.4115               | 0.6172           | 1.3578 | 2.0573 |
| 10h                     | 16  | 30h       | 0.4167               | 0.6250           | 1.3750 | 2.0833 |
| 11h                     | 17  | 31h       | 0.4219               | 0.6328           | 1.3922 | 2.1094 |
| 12h                     | 18  | 32h       | 0.4271               | 0.6406           | 1.4094 | 2.1354 |
| 13h                     | 19  | 33h       | 0.4323               | 0.6484           | 1.4266 | 2.1615 |
| 14h                     | 20  | 34h       | 0.4375               | 0.6563           | 1.4438 | 2.1875 |
| 15h                     | 21  | 35h       | 0.4427               | 0.6641           | 1.4609 | 2.2135 |
| 16h                     | 22  | 36h       | 0.4479               | 0.6719           | 1.4781 | 2.2396 |
| 17h                     | 23  | 37h       | 0.4531               | 0.6797           | 1.4953 | 2.2656 |
| 18h                     | 24  | 38h       | 0.4583               | 0.6875           | 1.5125 | 2.2917 |
| 19h                     | 25  | 39h       | 0.4635               | 0.6953           | 1.5297 | 2.3177 |
| 1Ah                     | 26  | 3Ah       | 0.4688               | 0.7031           | 1.5469 | 2.3438 |
| 1Bh                     | 27  | 3Bh       | 0.4740               | 0.7109           | 1.5641 | 2.3698 |
| 1Ch                     | 28  | 3Ch       | 0.4792               | 0.7188           | 1.5813 | 2.3958 |
| 1Dh                     | 29  | 3Dh       | 0.4844               | 0.7266           | 1.5984 | 2.4219 |
| 1Eh                     | 30  | 3Eh       | 0.4896               | 0.7344           | 1.6156 | 2.4479 |
| 1Fh                     | 31  | 3Fh       | 0.4948               | 0.7422           | 1.6328 | 2.4740 |
| 20h                     | 32  | 40h       | 0.5000               | 0.7500           | 1.6500 | 2.5000 |
| 21h                     | 33  | 41h       | 0.5052               | 0.7578           | 1.6672 | 2.5260 |
| 22h                     | 34  | 42h       | 0.5104               | 0.7656           | 1.6844 | 2.5521 |
| 23h                     | 35  | 43h       | 0.5156               | 0.7734           | 1.7016 | 2.5781 |
| 24h                     | 36  | 44h       | 0.5208               | 0.7813           | 1.7188 | 2.6042 |
| 25h                     | 37  | 45h       | 0.5260               | 0.7891           | 1.7359 | 2.6302 |
| 26h                     | 38  | 46h       | 0.5313               | 0.7969           | 1.7531 | 2.6563 |
| 27h                     | 39  | 47h       | 0.5365               | 0.8047           | 1.7703 | 2.6823 |
| 28h                     | 40  | 48h       | 0.5417               | 0.8125           | 1.7875 | 2.7083 |
| 29h                     | 41  | 49h       | 0.5469               | 0.8203           | 1.8047 | 2.7344 |
| 2Ah                     | 42  | 4Ah       | 0.5521               | 0.8281           | 1.8219 | 2.7604 |
| 2Bh                     | 43  | 4Bh       | 0.5573               | 0.8359           | 1.8391 | 2.7865 |
| 2Ch                     | 44  | 4Ch       | 0.5625               | 0.8438           | 1.8563 | 2.8125 |
| 2Dh                     | 45  | 4Dh       | 0.5677               | 0.8516           | 1.8734 | 2.8385 |
| 2Eh                     | 46  | 4Eh       | 0.5729               | 0.8594           | 1.8906 | 2.8646 |
| 2Fh                     | 47  | 4Fh       | 0.5781               | 0.8672           | 1.9078 | 2.8906 |
| 30h                     | 48  | 50h       | 0.5833               | 0.8750           | 1.9250 | 2.9167 |
| 31h                     | 49  | 51h       | 0.5885               | 0.8828           | 1.9422 | 2.9427 |
| 32h                     | 50  | 52h       | 0.5938               | 0.8906           | 1.9594 | 2.9688 |
| 33h                     | 51  | 53h       | 0.5990               | 0.8984           | 1.9766 | 2.9948 |
| 34h                     | 52  | 54h       | 0.6042               | 0.9063           | 1.9938 | 3.0208 |
| 35h                     | 53  | 55h       | 0.6094               | 0.9141           | 2.0109 | 3.0469 |
| 36h                     | 54  | 56h       | 0.6146               | 0.9219           | 2.0281 | 3.0729 |
| 37h                     | 55  | 57h       | 0.6198               | 0.9297           | 2.0453 | 3.0990 |
| 38h                     | 56  | 58h       | 0.6250               | 0.9375           | 2.0625 | 3.1250 |
| 39h                     | 57  | 59h       | 0.6302               | 0.9453           | 2.0797 | 3.1510 |
| 3Ah                     | 58  | 5Ah       | 0.6354               | 0.9531           | 2.0969 | 3.1771 |
| 3Bh                     | 59  | 5Bh       | 0.6406               | 0.9609           | 2.1141 | 3.2031 |
| 3Ch                     | 60  | 5Ch       | 0.6458               | 0.9688           | 2.1313 | 3.2292 |
| 3Dh                     | 61  | 5Dh       | 0.6510               | 0.9766           | 2.1484 | 3.2552 |
| 3Eh                     | 62  | 5Eh       | 0.6563               | 0.9844           | 2.1656 | 3.2813 |
| 3Fh                     | 63  | 5Fh       | 0.6616               | 0.9922           | 2.1828 | 3.3073 |
| 40h                     | 64  | 60h       | 0.6667               | 1.0000           | 2.2000 | 3.3333 |

- Note 1:** The I<sup>2</sup>C 7-bit write data value (serial shift register) will be offset by -20h, That is I<sup>2</sup>C 7-bit write value = 20h, wiper code = 00h. See [Section 6.4](#) for additional information.
- 2:** V<sub>OUT</sub> voltages based on R<sub>FS</sub> and R<sub>ZS</sub> = 0Ω .

## 7.1.3 AMPLIFIER INPUT VOLTAGE ( $V_W$ )

The input voltage into the Output Amplifier has requirements to ensure the input is in the linear range of the amplifier.

To ensure that the amplifier is operating in its linear range, the amplifier's input voltage ( $V_W$ ) has some requirements that must be met.

For device  $V_{DD}$  voltages  $\geq 3.0V$ , the amplifier is in the linear region for all  $V_{REF}$  voltages ( $\geq 1.0V$ ) and DAC register codes.

For device  $V_{DD}$  voltages  $< 3.0V$ , then the interaction between the device  $V_{DD}$  and the amplifier input voltage ( $V_W$ ) need to be taken into account. The  $V_W$  voltage is dependent on the  $V_{REF}$  voltage and the DAC register code. Here is the amplifier requirement that must be met:

$$V_W \leq (V_{DD} - 1.0V) / (2/3)$$

If  $V_{REF} = V_{DD}$  and  $V_{OUT}$  will have full-scale output, then:

$$V_{REF} \leq (V_{DD} - 1.0V) / (2/3)$$

Table 7-2 shows the maximum  $V_{REF}$  voltage (for  $V_{DD} < 3.0V$ ) if the DAC output ( $V_{OUT}$ ) will operate over the full range of DAC register codes.

**TABLE 7-2:  $V_{REF} \neq V_{DD}$  AND FULL-SCALE OUTPUT**

| $V_{DD}$ | $V_{REF}$ | Comment                                   |
|----------|-----------|---|
| 3.0      | 3.00      | $V_{REF}$ pin can be tied to $V_{DD}$ pin |
| 2.7      | 2.55      |   |
| 2.5      | 2.25      |   |
| 2.2      | 1.80      |   |
| 2.0      | 1.50      |   |
| 1.8      | 1.20      |   |

Table 7-3 shows the maximum DAC register code when the  $V_{REF}$  pin is tied to the  $V_{DD}$  voltage (for  $V_{DD} < 3.0V$ ). For DAC register codes above this, the  $V_{OUT}$  linearity may be degraded (out of specification).

**TABLE 7-3:  $V_{REF} = V_{DD}$  AND NOT FULL-SCALE OUTPUT**

| $V_{DD} = V_{REF}$ | $V_W$ | Max DAC Register Code | Comment            |
|--------------------|-------|-----------------------|--------------------|
| 3.0                | 3.00  | 60h-FFh               | This is Full Scale |
| 2.7                | 2.55  | 58h                   |                    |
| 2.5                | 2.25  | 53h                   |                    |
| 2.2                | 1.80  | 48h                   |                    |
| 2.0                | 1.50  | 40h                   |                    |
| 1.8                | 1.20  | 35h                   |                    |

The  $V_{REF}$  pin voltage and the maximum DAC register code can be optimized between the maximum DAC register code desired and the  $V_{REF}$  pin voltage. So when the  $V_{REF}$  voltage  $< V_{DD}$  voltage  $< 3.0V$ , then the DAC register code can be some value greater than the code shown in Table 7-3. Figure 7-2 shows the equations for solving for  $V_{OUT}$  voltage, the  $V_{REF}$  voltage, or the maximum DAC register code, based on knowing the requirements for two of these variables. The DAC register code of 64 is the full-scale code, and any number greater than 64 is invalid.

$$V_{OUT} = \frac{2 * V_{REF}}{3} * \frac{DAC \text{ Code}}{64}$$

$$V_{REF} = \frac{3 * V_{OUT}}{\frac{DAC \text{ Code}}{64} + 1}$$

$$DAC \text{ Code} = 64 * \frac{3 * V_{OUT}}{2 * V_{REF}}$$

**FIGURE 7-2:** Solving for  $V_{OUT}$ ,  $V_{REF}$  or DAC Register Code.

# MCP47DA1

## 7.2 Output Slew Rate

Figure 7-3 shows an example of the slew rate of the  $V_{OUT}$  pin. The slew rate can be affected by the characteristics of the circuit connected to the  $V_{OUT}$  pin.

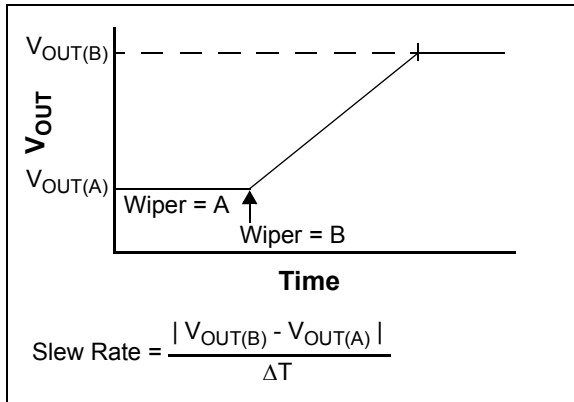


FIGURE 7-3:  $V_{OUT}$  pin Slew Rate.

### 7.2.1 SMALL CAPACITIVE LOAD

With a small capacitive load, the output buffer's current is not affected by the capacitive load ( $C_L$ ). But still, the  $V_{OUT}$  pin's voltage is not a step transition from one output value (wiper code value) to the next output value. The change of the  $V_{OUT}$  voltage is limited by the output buffer's characteristics, so the  $V_{OUT}$  pin voltage will have a slope from the old voltage to the new voltage. This slope is fixed for the output buffer, and is referred to as the buffer slew rate ( $SR_{BUF}$ ).

### 7.2.2 LARGE CAPACITIVE LOAD

With a larger capacitive load, the slew rate is determined by two factors:

- The output buffer's short circuit current ( $I_{SC}$ )
- The  $V_{OUT}$  pin's external load

$I_{OUT}$  cannot exceed the output buffer's short circuit current ( $I_{SC}$ ), which fixes the output buffer slew rate ( $SR_{BUF}$ ). The voltage on the capacitive load ( $C_L$ ),  $V_{CL}$ , changes at a rate proportional to  $I_{OUT}$ , which fixes a capacitive load slew rate ( $SR_{CL}$ ).

So the  $V_{CL}$  voltage slew rate is limited to the slower of the output buffer's internally set slew rate ( $SR_{BUF}$ ) and the capacitive load slew rate ( $SR_{CL}$ ).

## 7.3 Driving Resistive and Capacitive Loads

The  $V_{OUT}$  pin can drive up to 100 pF of capacitive load in parallel with a 5 k $\Omega$  resistive load (to meet electrical specifications). Figure 2-84 shows the  $V_{OUT}$  vs. Resistive Load.

$V_{OUT}$  drops slowly as the load resistance decreases after about 3.5 k $\Omega$ . It is recommended to use a load with  $R_L$  greater than 5 k $\Omega$ .

Driving large capacitive loads can cause stability problems for voltage feedback op amps. As the load capacitance increases, the feedback loop's phase margin decreases and the closed-loop bandwidth is reduced. This produces gain peaking in the frequency response with overshoot and ringing in the step response. That is, since the  $V_{OUT}$  pin's voltage does not quickly follow the buffer's input voltage (due to the large capacitive load), the output buffer will overshoot the desired target voltage. Once the driver detects this overshoot, it compensates by forcing it to a voltage below the target. This causes voltage ringing on the  $V_{OUT}$  pin.

So, when driving large capacitive loads with the output buffer, a small series resistor ( $R_{ISO}$ ) at the output (see Figure 7-4) improves the output buffer's stability (feedback loop's phase margin) by making the output load resistive at higher frequencies. The bandwidth will be generally lower than the bandwidth with no capacitive load.

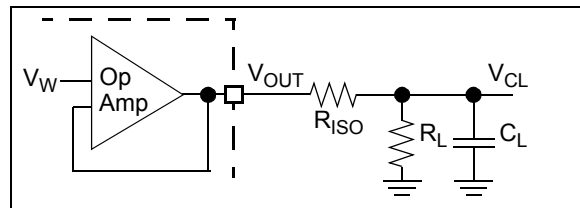


FIGURE 7-4: Circuit to Stabilize Output Buffer for Large Capacitive Loads ( $C_L$ ).

The  $R_{ISO}$  resistor value for your circuit needs to be selected. The resulting frequency response peaking and step response overshoot for this  $R_{ISO}$  resistor value should be verified on the bench. Modify the  $R_{ISO}$ 's resistance value until the output characteristics meet your requirements.

A method to evaluate the system's performance is to inject a step voltage on the  $V_{REF}$  pin and observe the  $V_{OUT}$  pin's characteristics.

**Note:** Additional insight into circuit design for driving capacitive loads can be found in AN884, "Driving Capacitive Loads With Op Amps" (DS00884).



## 7.4 Output Errors

The output error is caused by two factors. These are:

- Characteristics of the Resistor Network
- Characteristics of the Output Buffer

Figure 7-5 shows the components of the error on the output voltage. The first part of the error is from the resistor ladder and the  $R_{FS}$  and  $R_{ZS}$  resistances. The second part is due to the output buffer's input offset characteristics.

The  $R_{FS}$  and  $R_{ZS}$  resistances effect the voltage between  $V_{ZS}$  and  $V_{FS}$ . The larger that  $R_{FS} + R_{ZS}$  is, the smaller that the step voltage ( $V_S$ ) will be (from the theoretical step voltage). The increase in the  $R_{FS}$  and  $R_{ZS}$  resistances also effects the Full-Scale Error (FSE), Zero-Scale Error (ZSE), and gain error.

Table 7-4 compares theoretical resistor network voltages for full scale and zero scale, where  $R_{FS} = R_{ZS} = 0\Omega$ , to an example where  $R_{FS}$  and  $R_{ZS}$  and non-zero. The voltage calculations show cases of  $V_{REF} = 5.0V$  and  $V_{REF} = 1.5V$ . Figure 2-89 shows  $R_{VREF}$ ,  $R_{FS}$ , and  $R_{ZS}$  resistances  $V_{DD}$ .

So, as the voltage reference ( $V_{REF}$ ) decreases, the Step voltages ( $V_S$ ) decrease. At a low  $V_{REF}$  voltage, the step voltage approaches the magnitude of the output buffer's input offset voltage (design target of  $\pm 4.5 mV$ ). So, for low  $V_{REF}$  voltages, the output buffer errors have greater influence on the  $V_{OUT}$  voltage.

TABLE 7-4: CALCULATION COMPARISON

|                        | Example         | Theoretical     | Delta          |
|------------------------|-----------------|-----------------|----------------|
| $R_{VREF}$             | 30,180 $\Omega$ |                 | —              |
| $R_{FS}$               | 100 $\Omega$    | 0 $\Omega$      | 100 $\Omega$   |
| $R_{ZS}$               | 80 $\Omega$     | 0 $\Omega$      | 80 $\Omega$    |
| $R_1 + 64 * R_S + R_2$ | 30,000 $\Omega$ | 30,180 $\Omega$ | - 180 $\Omega$ |
| $R_1, R_{AB}, R_2$     | 10,000 $\Omega$ | 10,060 $\Omega$ | - 60 $\Omega$  |
| $V_{REF}$              | 5.00 V          |                 | —              |
| $V_{FS}$               | 3.3267 V        | 3.3333 V        | - 6.6 mV       |
| $V_{ZS}$               | 1.6700 V        | 1.6667 V        | + 3.3 mV       |
| $V_S$                  | 25.88 mV        | 26.04 mV        | - 0.16 mV      |
| $V_{REF}$              | 1.5V            |                 | —              |
| $V_{FS}$               | 0.9980 V        | 1.0000 V        | - 2.0 mV       |
| $V_{ZS}$               | 0.5010 V        | 0.5000 V        | + 1.0 mV       |
| $V_S$                  | 7.766 mV        | 7.813 mV        | -0.047mV       |

**Note 1:**  $R_{VREF} = R_1 + R_{AB} + R_2$ ,  
 $R_{AB} = R_{FS} + 64 * R_S + R_{ZS}$ .  
 $V_S = (V_{FS} - V_{ZS}) / 64$

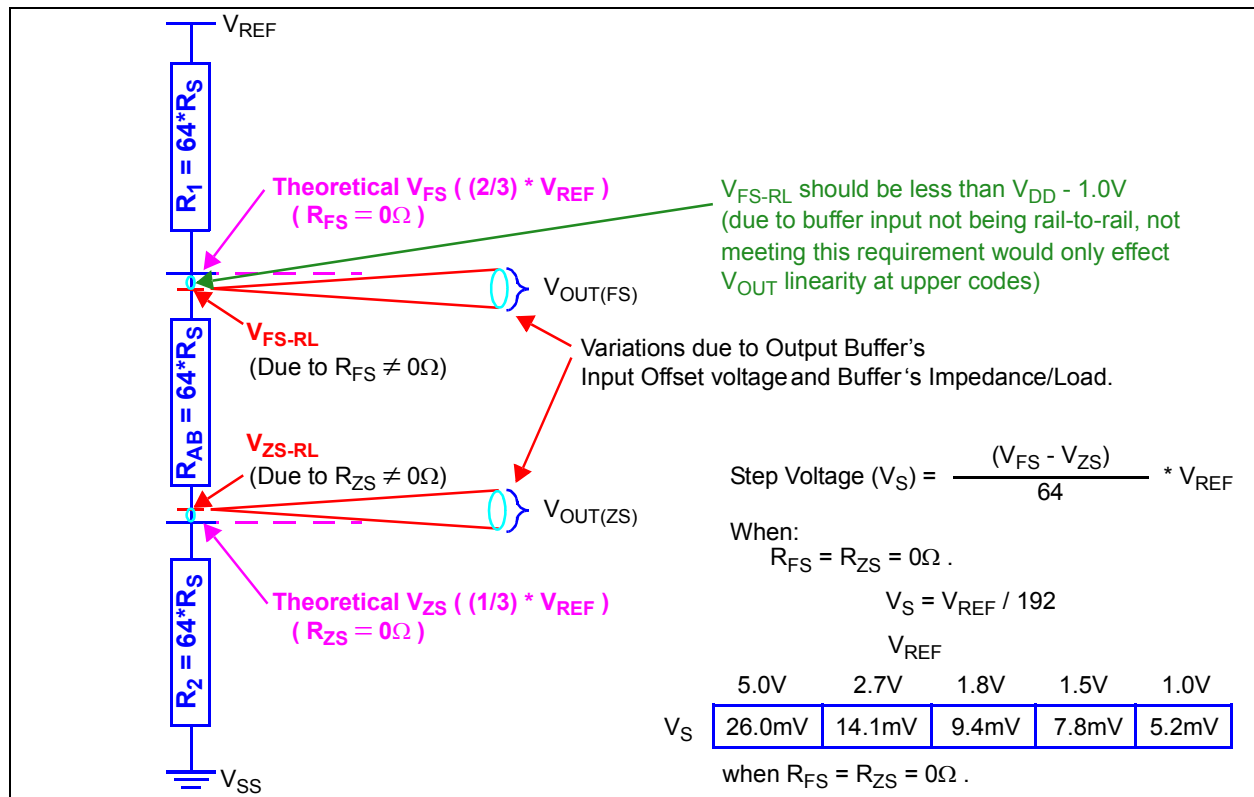


FIGURE 7-5: Output Voltage ( $V_{OUT}$ ) Error.

# MCP47DA1

---

NOTES:

## 8.0 APPLICATIONS EXAMPLES

The MCP47DA1 family of devices are general purpose, single-channel voltage output DACs for various applications where a precision operation with low power is needed.

The MCP47DA1 devices are rail-to-rail output DACs designed to operate with a  $V_{DD}$  range of 2.7V to 5.5V. The internal output op amplifier is robust enough to drive common, small-signal loads directly, thus eliminating the cost and size of external buffers for most applications.

Applications generally suited for the devices are:

- Set Point or Offset Trimming
- Sensor Calibration
- Portable Instrumentation (Battery Powered)
- Motor Control

Application examples include:

- [DC Set Point or Calibration](#)
- [Decreasing Output Step Size](#)
- [Building a “Window” DAC](#)
- [Selectable Gain and Offset Bipolar Voltage Output](#)
- [Building Programmable Current Source](#)
- [Serial Interface Communication Times](#)
- [Software I2C Interface Reset Sequence](#)

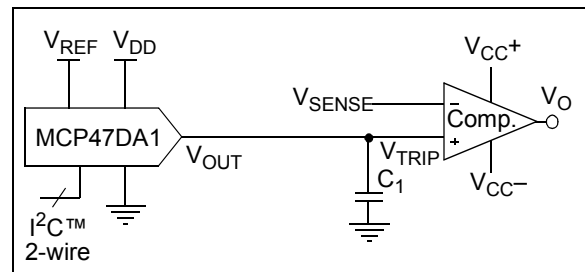
In the design of a system with MCP47DA1 devices, the following considerations should be taken into account:

- [Power Supply Considerations \(Noise\)](#)
- [PCB Area Requirements](#)
- [Connecting to I2C BUS using Pull-Up Resistors](#)

## 8.1 DC Set Point or Calibration

A common application for the devices is a digitally-controlled set point and/or calibration of variable parameters, such as sensor offset or slope. For example, the MCP47DA1 provides 64 output steps over 1/3 of the voltage reference range. If voltage reference is 1.65V, the LSb size is  $1.65V / 192$ , or ~ 8.6 mV.

Applications that need accurate detection of an input threshold event often need several sources of error eliminated. Use of comparators and operational amplifiers (op amps) with low offset and gain error can help achieve the desired accuracy, but in many applications, the input source variation is beyond the designer’s control. If the entire system can be calibrated after assembly in a controlled environment (like factory test), these sources of error are minimized if not entirely eliminated. [Figure 8-1](#) illustrates this example circuit. [Equation 8-1](#) shows a quick estimation of the wiper value given the desired voltage trip ( $V_{TRIP}$ ) point.



**FIGURE 8-1:** Set Point or Threshold Calibration.

### EQUATION 8-1: ESTIMATING THE WIPER VALUE (N) FROM THE DESIRED $V_{TRIP}$

$$V_{TRIP} = V_{OUT} = (1/3) * V_{REF} + (N * V_S)$$

$$N = \frac{(V_{TRIP} - ((1/3) * V_{REF}))}{V_S}$$

Where:  $V_S = V_{REF} / 192$

**Note:** Calculation does not take into account  $R_{FS}$  and  $R_{ZS}$  resistors of the DAC’s resistor ladder (see [Section 7.1](#) for

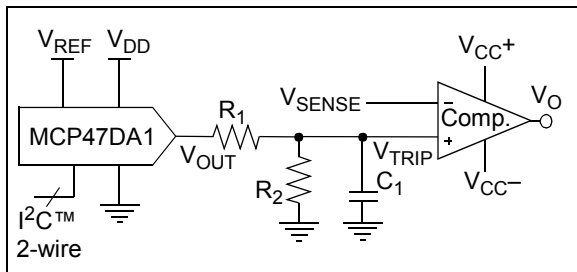
# MCP47DA1

## 8.1.1 DECREASING OUTPUT STEP SIZE

Due to the step voltage and output range of the MCP47DA1, it may be desirable to reduce the step voltage while also modifying the range of the output. A common method to achieve this smaller step size is a voltage divider on the DAC's output. This allows the  $V_{TRIP}$  voltage to be lower than the minimum output voltage of the DAC ( $1/3 * V_{REF}$ ). Figure 8-2 illustrates this concept. Equation 8-2 shows a quick estimation of the wiper value given the desired voltage trip ( $V_{TRIP}$ ) point.

So, for example, if  $R_1 = R_2$ , then the  $V_{TRIP}$  voltage range is from  $1/6 * V_{REF}$  to  $1/3 * V_{REF}$ , where the  $V_{OUT}$  voltage range is from  $1/3 * V_{REF}$  to  $2/3 * V_{REF}$ . Also at the  $V_{TRIP}$  node, the step voltage is  $1/2$  the step voltage at the  $V_{OUT}$  node.

A bypass capacitor on the output of the voltage divider plays a critical function in attenuating the output noise of the DAC and the induced noise from the environment.



**FIGURE 8-2:** Example Circuit Of Set Point or Threshold Calibration.

### EQUATION 8-2: $V_{OUT}$ AND $V_{TRIP}$ ESTIMATIONS

$$V_{OUT} = (1/3) * V_{REF} + (N * V_S)$$

$$V_S = V_{REF} / 192$$

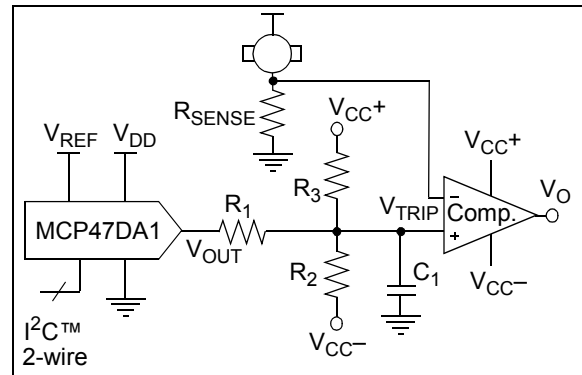
$$V_{TRIP} = V_{OUT} * \frac{R_2}{R_1 + R_2}$$

**Note:** The  $V_{OUT}$  voltage can also be scaled by a resistor from the  $V_{REF}$  pin to the system reference voltage. Care should be taken with this implementation due to the  $\pm 20\%$  variation to the  $30k\Omega$  typical resistance from the  $V_{REF}$  pin to ground ( $R_{VREF}$ ). This variation in resistance directly effects the actual  $V_{OUT}$  voltage.

## 8.1.2 BUILDING A "WINDOW" DAC

When calibrating a set point or threshold of a sensor, typically only a small portion of the DAC output range is utilized. If the LSB size is adequate enough to meet the application's accuracy needs, the unused range is sacrificed without consequences. If greater accuracy is needed, then the output range will need to be reduced to increase the resolution around the desired threshold.

If the threshold is not near  $V_{REF} * 2 * V_{REF}$ , or  $V_{SS}$  then creating a "window" around the threshold has several advantages. One simple method to create this "window" is to use a voltage divider network with a pull-up and pull-down resistor. Figure 8-3 and Figure 8-4 illustrate this concept.



**FIGURE 8-3:** Single-Supply "Window" DAC.

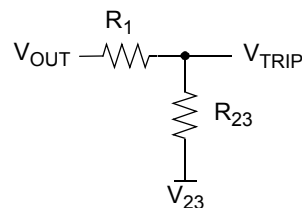
### EQUATION 8-3: $V_{OUT}$ AND $V_{TRIP}$ ESTIMATIONS

$$V_{OUT} = (1/3) * V_{REF} + (N * V_S)$$

$$V_S = V_{REF} / 192$$

$$V_{TRIP} = \frac{V_{OUT} * R_{23} + V_{23} * R_1}{R_1 + R_{23}}$$

$$\text{Thevenin Equivalent} \left\{ \begin{array}{l} R_{23} = \frac{R_2 * R_3}{R_2 + R_3} \\ V_{23} = \frac{(V_{CC+} * R_2) * (V_{CC-} * R_3)}{R_2 + R_3} \end{array} \right.$$

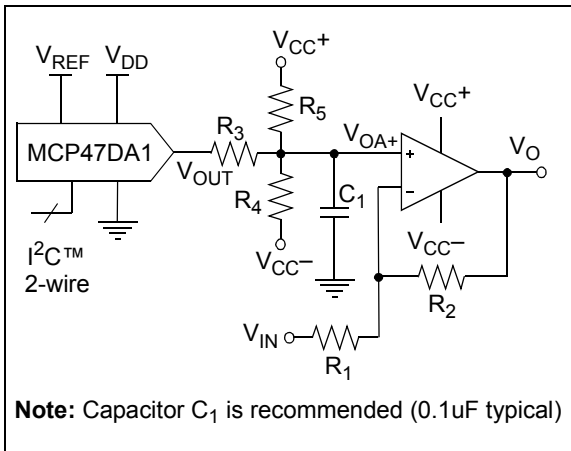


## 8.2 Selectable Gain and Offset Bipolar Voltage Output

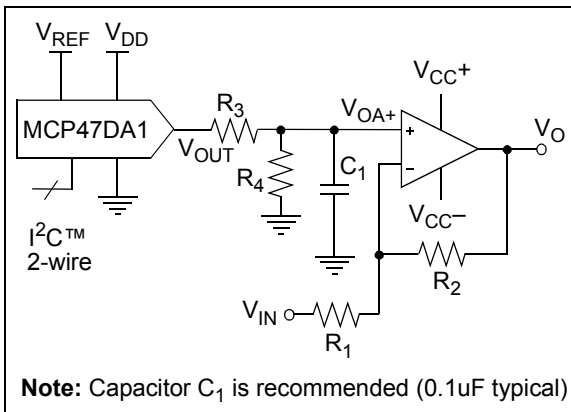
In some applications, control of the output range is desirable. Figure 8-4 shows a circuit using a DAC device to achieve a bipolar or single-supply application. This circuit is typically used for linearizing a sensor whose slope and offset varies. Depending on the output range desired, resistor  $R_4$  or resistor  $R_5$  may not be required. Equation 8-4 shows the calculation of the gain, while Equation 8-5 shows the calculation of the  $V_O$  voltage.

This circuit can be simplified if the window range is limited (by removing either the  $R_4$  or  $R_5$  resistor). Figure 8-5 shows a circuit for the case where the  $R_5$  resistor is removed. Resistors  $R_1$  and  $R_2$  control the gain, while resistors  $R_3$  and  $R_4$  shift the DAC's output to a selected offset. Equation 8-6 shows the calculation of the  $V_O$  voltage.

**Note:**  $R_4$  can be tied to  $V_{DD}$ , instead of  $V_{SS}$ , if a higher offset is desired.



**FIGURE 8-4:** Bipolar Voltage Source with Selectable Gain and Offset Circuit.



**FIGURE 8-5:** Simplified Bipolar Voltage Source with Selectable Gain and Offset Circuit.

### EQUATION 8-4: GAIN CALCULATION

$$\text{Gain} = \frac{R_2}{R_1}$$

If desired Gain = 0.5, and  $R_1$  is selected as 20 k $\Omega$  then  $R_2$  would need to be 10 k $\Omega$ .

### EQUATION 8-5: BIPOLAR "WINDOW" DAC CALCULATIONS

$$V_O = \underbrace{V_{OA+} \cdot \left(1 + \frac{R_2}{R_1}\right)}_{\text{Offset Adjust}} - \underbrace{V_{IN} \cdot \left(\frac{R_2}{R_1}\right)}_{\text{Gain Adjust}}$$

$$V_{OA+} = \frac{(V_{OUT} \cdot R_{45}) + (V_{45} \cdot R_3)}{R_3 + R_{45}}$$

$$V_{45} = \frac{(V_{CC+} \cdot R_4) + (V_{CC-} \cdot R_5)}{R_4 + R_5}$$

$$R_{45} = \frac{R_4 \cdot R_5}{R_4 + R_5}$$

$$V_{OUT} = (1/3) \cdot V_{REF} + (N \cdot V_S) \quad (1)$$

$$V_S = \frac{V_{REF}}{192}$$

**Note 1:**  $V_{OUT}$  calculation does not take into account  $R_{FS}$  and  $R_{ZS}$  resistors of the DAC's resistor ladder (see Section 7.1 for additional information).

### EQUATION 8-6: SIMPLIFIED BIPOLAR "WINDOW" DAC CALCULATIONS

$$V_O = V_{OA+} \cdot \left(1 + \frac{R_2}{R_1}\right) - V_{IN} \cdot \left(\frac{R_2}{R_1}\right)$$

$$V_{OA+} = V_{OUT} \cdot \left(\frac{R_4}{R_3 + R_4}\right)$$

$$V_{OUT} = (1/3) \cdot V_{REF} + (N \cdot V_S)$$

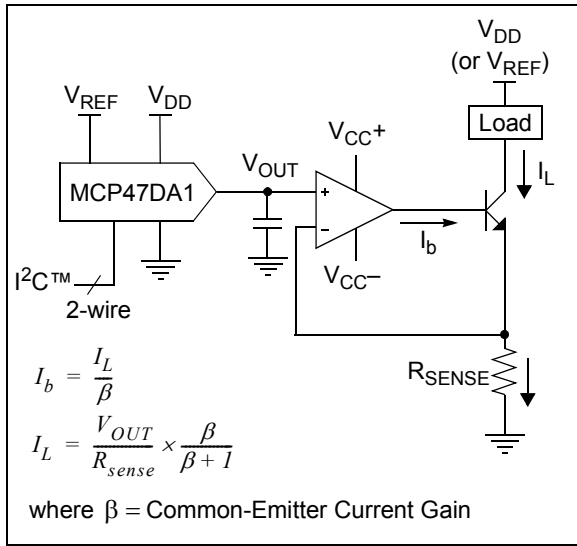
**Note 1:**  $V_{OUT}$  calculation does not take into account  $R_{FS}$  and  $R_{ZS}$  resistors of the DAC's resistor ladder (see Section 7.1 for additional information).

# MCP47DA1

## 8.3 Building Programmable Current Source

Figure 8-6 shows an example of building a programmable current source using a voltage follower. The current sensor resistor is used to convert the DAC voltage output into a digitally-selectable current source.

The smaller  $R_{SENSE}$  is, the less power is dissipated across it. However, this also reduces the resolution that the current can be controlled.



**FIGURE 8-6:** Digitally-Controlled Current Source.

## 8.4 Serial Interface Communication Times

Table 8-1 shows the time for each I<sup>2</sup>C Serial Interface command as well as the effective data update rate that can be supported by the digital interface (based on the two I<sup>2</sup>C serial interface frequencies). The continuous Write command allows a higher data update frequency, since for the fixed overhead, more bytes are transferred. So, the serial interface performance along with the  $V_{OUT}$  output performance (such as slew rate), is used to determine the application's volatile DAC register update rate.

**TABLE 8-1: SERIAL INTERFACE TIMES / FREQUENCIES**

| Command                | # of Serial Interface bits <sup>(1)</sup> | Example             |                            | Command Time (μs) |         | Effective Data Update Frequency (kHz) <sup>(2)</sup> |         |
|------------------------|---|---------------------|----------------------------|-------------------|---------|--|---------|
|                        |   | # Bytes Transferred | # of Serial Interface bits | 100 kHz           | 400 kHz | 100 kHz  | 400 kHz |
| Write Single byte      | 29  | 1                   | 29                         | 290.0             | 72.5    | 3.4  | 13.8    |
| Write Continuous bytes | 20 + N * 9                                | 5                   | 65                         | 650.0             | 162.5   | 7.7  | 30.8    |
| Read byte              | 39  | 1                   | 39                         | 390.0             | 97.5    | 2.6  | 10.3    |

**Note 1:** Includes the Start or Stop bits.

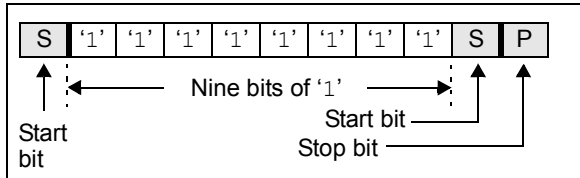
**2:** This is the command frequency multiplied by the number of bytes transferred.

## 8.5 Software I<sup>2</sup>C Interface Reset Sequence

**Note:** This technique should be supported by any I<sup>2</sup>C compliant device. The 24XXXX I<sup>2</sup>C Serial EEPROM devices support this technique, which is documented in AN1028.

At times, it may become necessary to perform a Software Reset Sequence to ensure the MCP47DA1 device is in a correct and known I<sup>2</sup>C Interface state. This technique only resets the I<sup>2</sup>C state machine.

This is useful if the MCP47DA1 device powers up in an incorrect state (due to excessive bus noise, etc), or if the master device is reset during communication. Figure 8-7 shows the communication sequence to software reset the device.



**FIGURE 8-7:** Software Reset Sequence Format.

The first Start bit will cause the device to reset from a state in which it is expecting to receive data from the master device. In this mode, the device is monitoring the data bus in Receive mode and can detect if the Start bit forces an internal Reset.

The nine bits of '1' are used to force a Reset of those devices that could not be reset by the previous Start bit. This occurs only if the MCP47DA1 is driving an  $\bar{A}$  bit on the I<sup>2</sup>C bus, or is in Output mode (from a Read command) and is driving a data bit of '0' onto the I<sup>2</sup>C bus. In both of these cases, the previous Start bit could not be generated due to the MCP47DA1 holding the bus low. By sending out nine '1' bits, it is ensured that the device will see an  $\bar{A}$  bit (the master device does not drive the I<sup>2</sup>C bus low to acknowledge the data sent by the MCP47DA1), which also forces the MCP47DA1 to reset.

The second Start bit is sent to address the rare possibility of an erroneous write. This could occur if the master device was reset while sending a Write command to the MCP47DA1, AND then as the master device returns to normal operation and issues a Start condition, while the MCP47DA1 is issuing an Acknowledge. In this case, if the second Start bit is not sent (and the Stop bit was sent) the MCP47DA1 could initiate a write cycle.

**Note:** The potential for this erroneous write ONLY occurs if the master device is reset while sending a Write command to the MCP47DA1.

The Stop bit terminates the current I<sup>2</sup>C bus activity. The MCP47DA1 waits to detect the next Start condition.

This sequence does not effect any other I<sup>2</sup>C devices which may be on the bus, as they should disregard this as an invalid command.

# MCP47DA1

## 8.6 Design Considerations

### 8.6.1 POWER SUPPLY CONSIDERATIONS (NOISE)

Inductively-coupled AC transients and digital switching noise can degrade the input and output signal integrity, potentially masking the MCP47DA1's performance. Careful board layout minimizes these effects and increases the Signal-to-Noise Ratio (SNR). Multi-layer boards utilizing a low-inductance ground plane, isolated inputs, isolated outputs and proper decoupling are suggested. Particularly harsh environments may require shielding of critical signals.

The device's power sources ( $V_{DD}$  and  $V_{REF}$ ) should be as clean as possible. Any noise induced on the  $V_{DD}$  and  $V_{REF}$  signals can affect the DAC performance. Separate digital and analog ground planes are recommended.

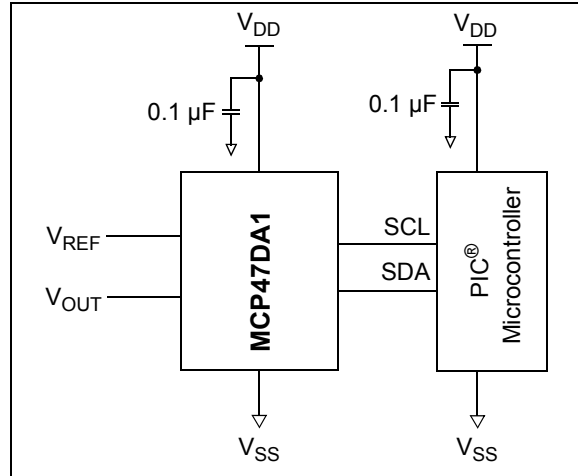
Typical applications require a bypass capacitor in order to filter high-frequency noise on the  $V_{DD}$  and  $V_{REF}$  signals. The noise can be induced onto the power supply's traces or as a result of changes on the DAC output. The bypass capacitor helps to minimize the effect of these noise sources on signal integrity. Figure 8-8 illustrates an appropriate bypass strategy.

In this example, the recommended bypass capacitor value is 0.1  $\mu\text{F}$ . This capacitor should be placed as close to the device power pin ( $V_{DD}$ ) as possible (within 4 mm).

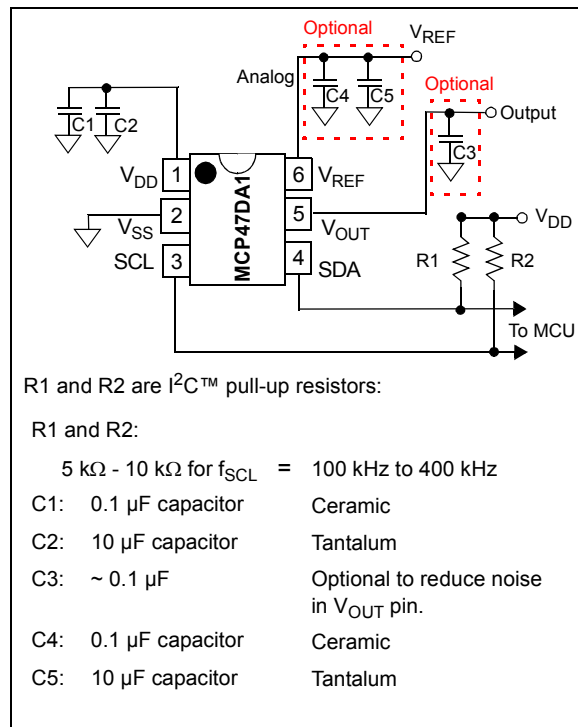
Separate digital and analog ground planes are recommended. In this case, the  $V_{SS}$  pin and the ground pins of the  $V_{DD}$  capacitors should be terminated to the analog ground plane and  $V_{DD}$  and  $V_{SS}$  should reside on the analog plane.

Figure 8-9 shows an example of using two bypass capacitors (a 10  $\mu\text{F}$  tantalum capacitor and a 0.1  $\mu\text{F}$  ceramic capacitor) in parallel on the  $V_{DD}$  line. These capacitors should be placed as close to the  $V_{DD}$  pin as possible (within 4 mm). If the application circuit has separate digital and analog power supplies, the  $V_{DD}$  and  $V_{SS}$  pins of the device should reside on the analog plane.

**Note:** Breadboards and wire-wrapped boards are not recommended.



**FIGURE 8-8:** Typical Microcontroller Connections.



R1 and R2 are I<sup>2</sup>C™ pull-up resistors:

R1 and R2:

5 k $\Omega$  - 10 k $\Omega$  for  $f_{SCL}$  = 100 kHz to 400 kHz

- |     |                             |  |
|-----|-----------------------------|--|
| C1: | 0.1 $\mu\text{F}$ capacitor | Ceramic                                    |
| C2: | 10 $\mu\text{F}$ capacitor  | Tantalum                                   |
| C3: | ~ 0.1 $\mu\text{F}$         | Optional to reduce noise in $V_{OUT}$ pin. |
| C4: | 0.1 $\mu\text{F}$ capacitor | Ceramic                                    |
| C5: | 10 $\mu\text{F}$ capacitor  | Tantalum                                   |

**FIGURE 8-9:** Example MCP47DA1 Circuit.



## 8.6.2 PCB AREA REQUIREMENTS

In some applications, PCB area is a criteria for device selection. Table 8-2 shows the typical package dimensions and area for the different package options.

**TABLE 8-2: PACKAGE FOOTPRINT (1)**

| Package |        |      | Package Footprint |       |                         |
|---------|--------|------|-------------------|-------|-------------------------|
| Pins    | Type   | Code | Dimensions (mm)   |       | Area (mm <sup>2</sup> ) |
|         |        |      | Length            | Width |                         |
| 6       | SOT-23 | OT   | 3.10              | 3.20  | 9.92                    |
| 6       | SC70   | LT   | 2.0               | 2.10  | 4.20                    |

**Note 1:** Does not include recommended Land Pattern dimensions. Dimensions are max. values.

## 8.6.3 FOOTPRINT COMPATIBILITY WITH MCP40D18

The MCP47DA1 in the SC70 package is footprint compatible with the MCP40D18 device. The  $V_{REF}$  pin is analogous to the A Terminal pin while the  $V_{OUT}$  pin is analogous to the W Terminal pin. The  $V_{OUT}$  pin is a buffered output so any buffering of the W Terminal pin may be able to be removed. Also, verify the resistor network's resistance to ensure the voltage source on the  $V_{REF}$  pin (A Terminal) can support the current requirements ( $I_{VREF}$  vs. the  $I_{RAB}$ ).

## 8.6.4 CONNECTING TO I<sup>2</sup>C BUS USING PULL-UP RESISTORS

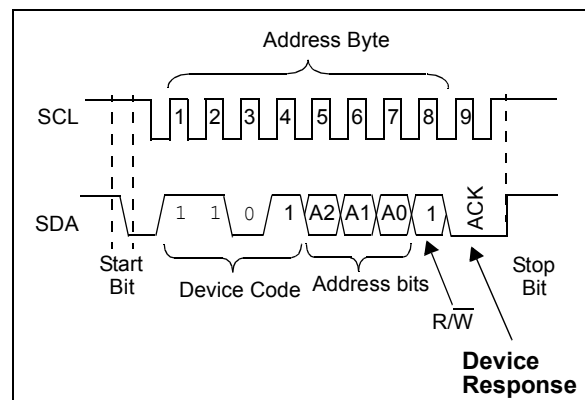
The SCL and SDA pins of the MCP47DA1 devices are open-drain configurations. These pins require a pull-up resistor as shown in Figure 8-9.

The pull-up resistor values ( $R_1$  and  $R_2$ ) for SCL and SDA pins depend on the operating speed (standard, fast, and high speed) and loading capacitance of the I<sup>2</sup>C bus line. A higher value of the pull-up resistor consumes less power, but increases the signal transition time (higher RC time constant) on the bus line. Therefore, it can limit the bus operating speed. The lower resistor value, on the other hand, consumes higher power, but allows higher operating speed. If the bus line has higher capacitance due to long metal traces or multiple device connections to the bus line, a smaller pull-up resistor is needed to compensate the long RC time constant. The pull-up resistor is typically chosen between 1 k $\Omega$  and 10 k $\Omega$  ranges for Standard and Fast modes.

### 8.6.4.1 Device Connection Test

The user can test the presence of the device on the I<sup>2</sup>C bus line using a simple I<sup>2</sup>C command. This test can be achieved by checking an acknowledge response from the device after sending a Read or Write command. Figure 8-10 shows an example with a Read command. The steps are:

- Set the  $R/\bar{W}$  bit "High" in the device's address byte.
- Check the ACK bit of the address byte.  
If the device acknowledges (ACK = 0) the command, then the device is connected, otherwise it is not connected.
- Send Stop bit.



**FIGURE 8-10: I<sup>2</sup>C Bus Connection Test.**

# MCP47DA1

---

NOTES:

## 9.0 DEVELOPMENT SUPPORT

### 9.1 Evaluation/Demonstration Boards

The MCP47DA1 devices do not have a dedicated Evaluation or Demonstration board. Figure 9-1 shows the component connections to make an evaluation board using the SC70EV Bond Out PCB (order number SC70EV) with the MCP47DA1 in a SOT-23-6 package. This will allow the MCP47DA1's capabilities to be evaluated with the PICKit™ Serial Analyzer (order number DV164122).

**Note:** Since the SC70EV is a generic board, the noise immunity of the board will not be optimal. If noise immunity is a requirement, then you will need to develop a custom PCB for the MCP47DA1. This PCB would need to use good layout techniques to reduce noise coupling.

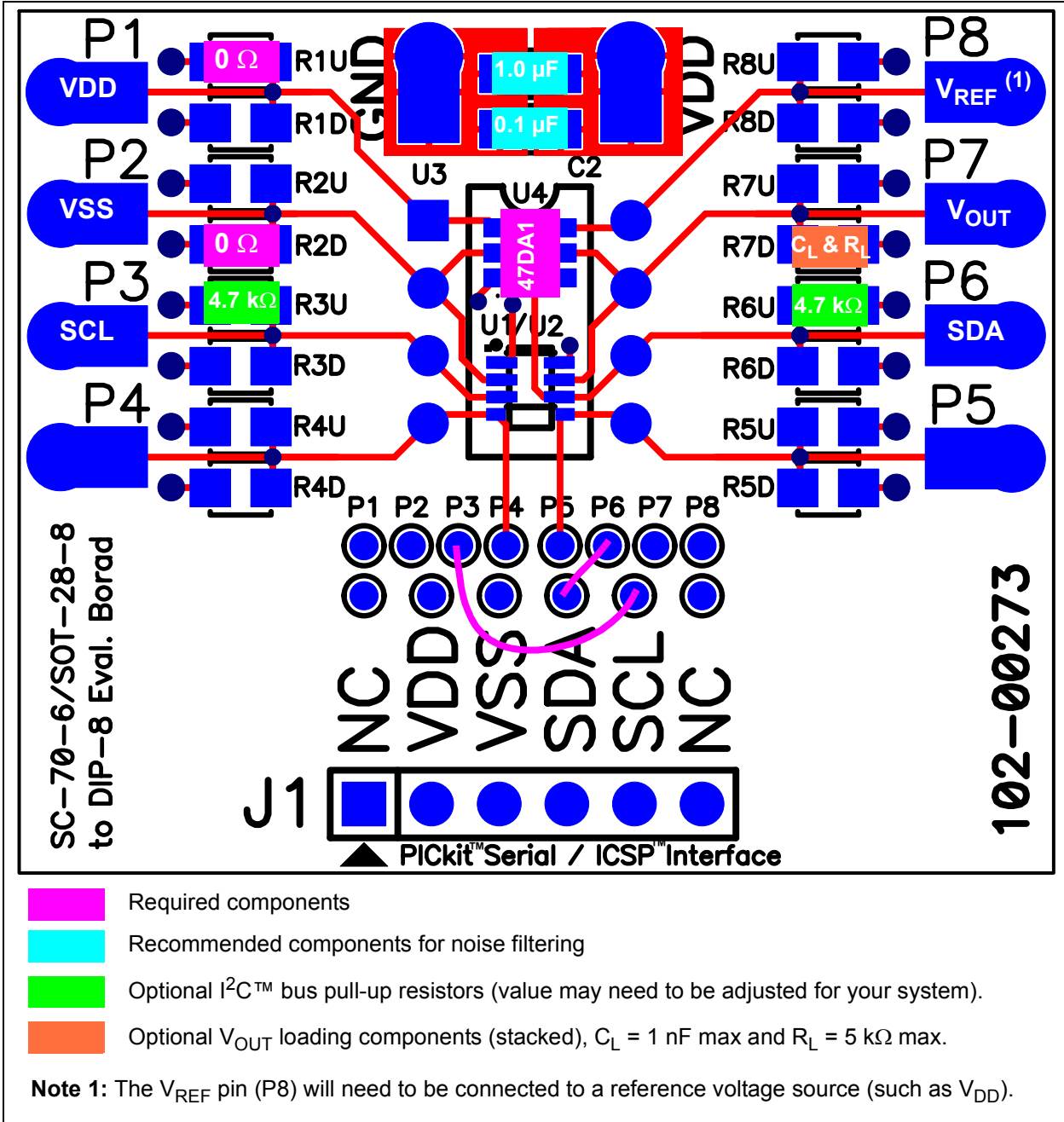


FIGURE 9-1: SC70EV Bond Out PCB – Top Layer and Silk-Screen.

# MCP47DA1

---

## 9.2 Technical Documentation

Several additional technical documents are available to assist in your design and development. These technical documents include Application Notes, Technical Briefs, and Design Guides. [Table 9-1](#) shows some of these documents.

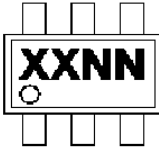
**TABLE 9-1: TECHNICAL DOCUMENTATION**

| Application Note Number | Title  | Literature # |
|-------------------------|--|--------------|
| AN1326                  | Using the MCP4728 12-Bit DAC for LDMOS Amplifier Bias Control Applications | DS01326      |
| —                       | Signal Chain Design Guide  | DS21825      |
| —                       | Analog Solutions for Automotive Applications Design Guide                  | DS01005      |

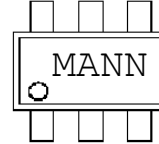
## 10.0 PACKAGING INFORMATION

### 10.1 Package Marking Information

6-Lead SOT-23

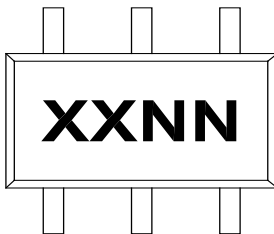


Example:

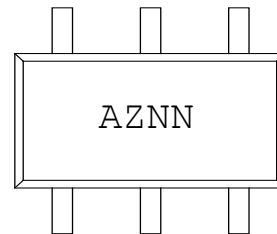


| Part Number      | Code | Part Number      | Code |
|------------------|------|------------------|------|
| MCP47DA1T-A0E/OT | MANN | MCP47DA1T-A1E/OT | M9NN |

6-Lead SC-70



Example



| Part Number      | Code | Part Number      | Code |
|------------------|------|------------------|------|
| MCP47DA1T-A0E/LT | AZNN | MCP47DA1T-A1E/LT | BBNN |

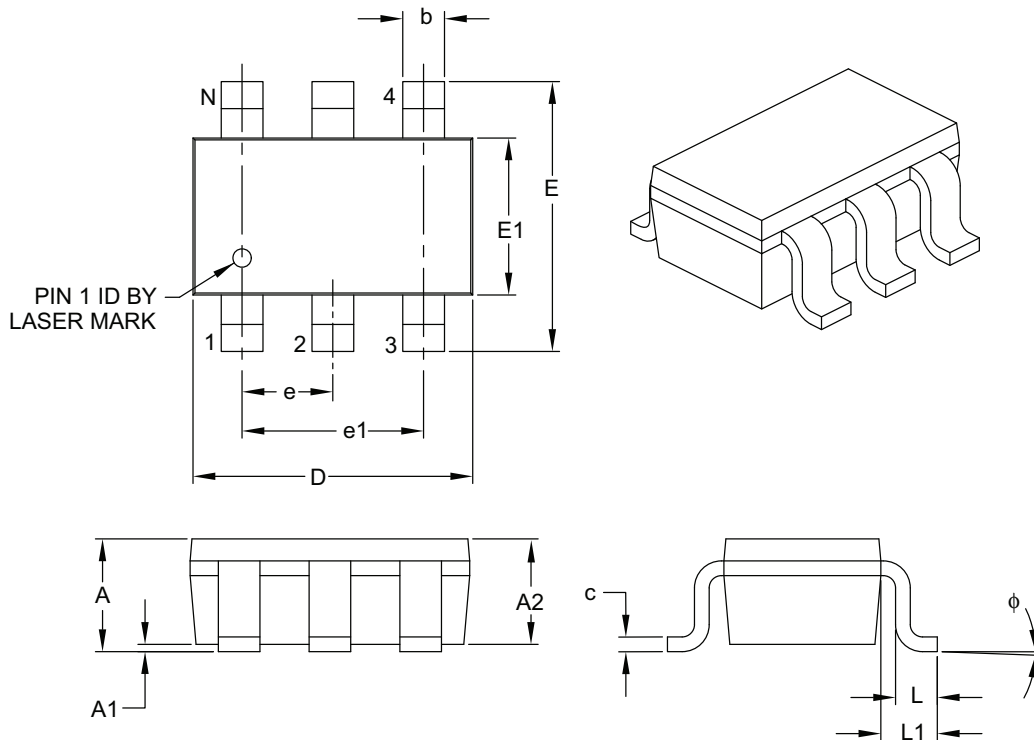
**Legend:** XX...X Customer-specific information  
 Y Year code (last digit of calendar year)  
 YY Year code (last 2 digits of calendar year)  
 WW Week code (week of January 1 is week '01')  
 NNN Alphanumeric traceability code  
 (e3) Pb-free JEDEC designator for Matte Tin (Sn)  
 \* This package is Pb-free. The Pb-free JEDEC designator (e3) can be found on the outer packaging for this package.

**Note:** In the event the full Microchip part number cannot be marked on one line, it will be carried over to the next line, thus limiting the number of available characters for customer-specific information.

# MCP47DA1

## 6-Lead Plastic Small Outline Transistor (OT) [SOT-23]

**Note:** For the most current package drawings, please see the Microchip Packaging Specification located at <http://www.microchip.com/packaging>



| Dimension Limits         | Units  | MILLIMETERS |     |      |
|--------------------------|--------|-------------|-----|------|
|                          |        | MIN         | NOM | MAX  |
| Number of Pins           | N      | 6           |     |      |
| Pitch                    | e      | 0.95 BSC    |     |      |
| Outside Lead Pitch       | e1     | 1.90 BSC    |     |      |
| Overall Height           | A      | 0.90        | –   | 1.45 |
| Molded Package Thickness | A2     | 0.89        | –   | 1.30 |
| Standoff                 | A1     | 0.00        | –   | 0.15 |
| Overall Width            | E      | 2.20        | –   | 3.20 |
| Molded Package Width     | E1     | 1.30        | –   | 1.80 |
| Overall Length           | D      | 2.70        | –   | 3.10 |
| Foot Length              | L      | 0.10        | –   | 0.60 |
| Footprint                | L1     | 0.35        | –   | 0.80 |
| Foot Angle               | $\phi$ | 0°          | –   | 30°  |
| Lead Thickness           | c      | 0.08        | –   | 0.26 |
| Lead Width               | b      | 0.20        | –   | 0.51 |

**Notes:**

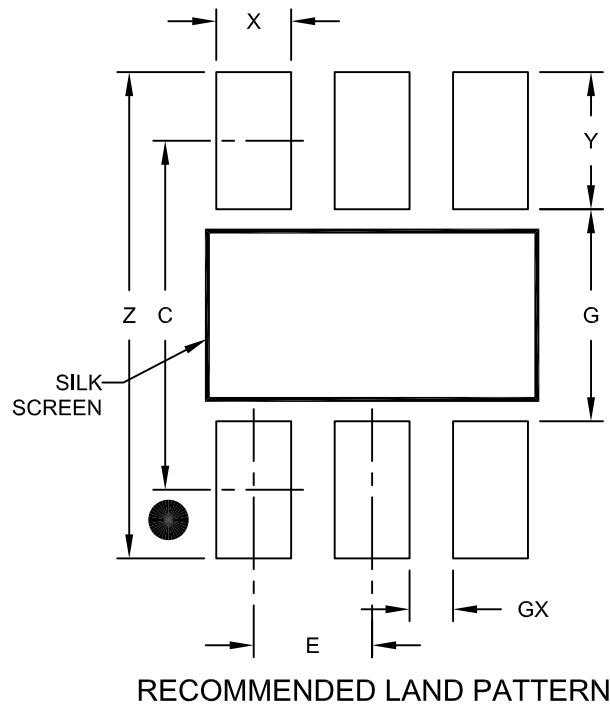
- Dimensions D and E1 do not include mold flash or protrusions. Mold flash or protrusions shall not exceed 0.127 mm per side.
- Dimensioning and tolerancing per ASME Y14.5M.

BSC: Basic Dimension. Theoretically exact value shown without tolerances.

Microchip Technology Drawing C04-028B

## 6-Lead Plastic Small Outline Transistor (OT) [SOT-23]

**Note:** For the most current package drawings, please see the Microchip Packaging Specification located at <http://www.microchip.com/packaging>



| Dimension Limits        | Units | MILLIMETERS |      |      |
|-------------------------|-------|-------------|------|------|
|                         |       | MIN         | NOM  | MAX  |
| Contact Pitch           | E     | 0.95 BSC    |      |      |
| Contact Pad Spacing     | C     |             | 2.80 |      |
| Contact Pad Width (X6)  | X     |             |      | 0.60 |
| Contact Pad Length (X6) | Y     |             |      | 1.10 |
| Distance Between Pads   | G     | 1.70        |      |      |
| Distance Between Pads   | GX    | 0.35        |      |      |
| Overall Width           | Z     |             |      | 3.90 |

**Notes:**

1. Dimensioning and tolerancing per ASME Y14.5M

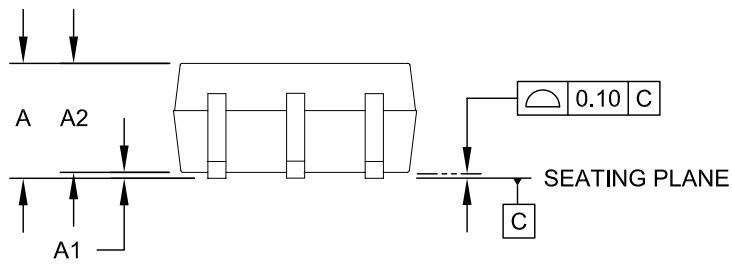
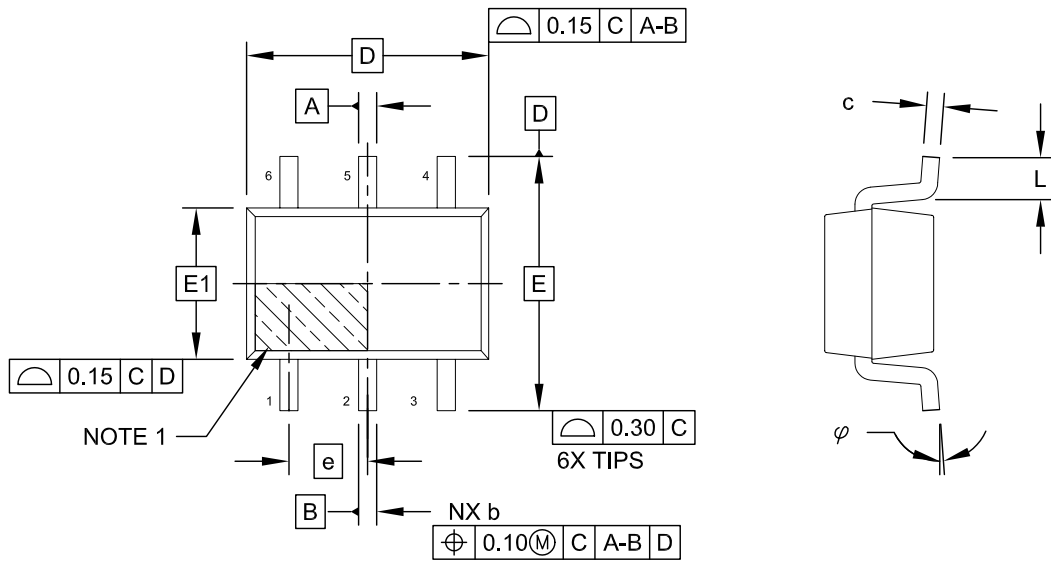
BSC: Basic Dimension. Theoretically exact value shown without tolerances.

Microchip Technology Drawing No. C04-2028A

# MCP47DA1

## 6-Lead Plastic Small Outline Transistor (LT) [SC70]

**Note:** For the most current package drawings, please see the Microchip Packaging Specification located at <http://www.microchip.com/packaging>

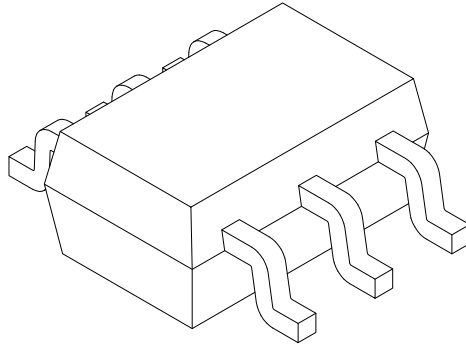


Microchip Technology Drawing No. C04-151A Sheet 1 of 2



## 6-Lead Plastic Small Outline Transistor (LT) [SC70]

**Note:** For the most current package drawings, please see the Microchip Packaging Specification located at <http://www.microchip.com/packaging>



| Dimension Limits         | Units | MILLIMETERS |      |      |
|--------------------------|-------|-------------|------|------|
|                          |       | MIN         | NOM  | MAX  |
| Number of Pins           | N     | 6           |      |      |
| Pitch                    | e     | 0.65 BSC    |      |      |
| Overall Height           | A     | 0.80        | -    | 1.10 |
| Molded Package Thickness | A2    | 0.70        | 0.90 | 1.00 |
| Standoff                 | A1    | 0.00        | -    | 0.10 |
| Overall Width            | E     | 2.10 BSC    |      |      |
| Molded Package Width     | E1    | 1.25 BSC    |      |      |
| Overall Length           | D     | 2.00 BSC    |      |      |
| Foot Length              | L     | 0.10        | 0.20 | 0.46 |
| Lead Thickness           | c     | 0.08        | -    | 0.22 |
| Lead Width               | b     | 0.15        | -    | 0.30 |

**Notes:**

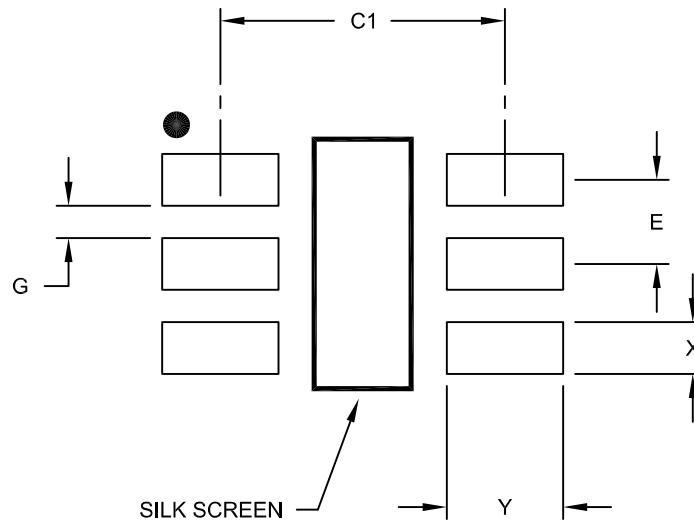
- Pin 1 visual index feature may vary, but must be located within the hatched area.
- Dimensions D and E1 do not include mold flash or protrusions. Mold flash or protrusions shall not exceed 0.15mm per side.
- Dimensioning and tolerancing per ASME Y14.5M  
BSC: Basic Dimension. Theoretically exact value shown without tolerances.

Microchip Technology Drawing No. C04-151A Sheet 2 of 2

# MCP47DA1

## 6-Lead Plastic Small Outline Transistor (LT) [SC70]

**Note:** For the most current package drawings, please see the Microchip Packaging Specification located at <http://www.microchip.com/packaging>



RECOMMENDED LAND PATTERN

| Dimension Limits        | Units | MILLIMETERS |      |      |
|-------------------------|-------|-------------|------|------|
|                         |       | MIN         | NOM  | MAX  |
| Contact Pitch           | E     | 0.65 BSC    |      |      |
| Contact Pad Spacing     | C     |             | 2.20 |      |
| Contact Pad Width (X6)  | X     |             |      | 0.40 |
| Contact Pad Length (X6) | Y     |             |      | 0.90 |
| Distance Between Pads   | G     | 0.25        |      |      |

**Notes:**

1. Dimensioning and tolerancing per ASME Y14.5M

BSC: Basic Dimension. Theoretically exact value shown without tolerances.

Microchip Technology Drawing No. C04-2151A

## APPENDIX A: REVISION HISTORY

### Revision D (March 2013)

The following is the list of modifications:

1. Changed the Typical Static Current value from 90  $\mu$ A to 100  $\mu$ A (on pages 1 and 4), and Maximum value from 130 $\mu$ A to 160 $\mu$ A (on page 4).
2. Split the CDM Absolute Maximum Rating into SOT-23 and SC70 packages. Change CDM values.
3. Changed the INL limit from  $\pm 0.5$  to  $\pm 0.7$ .
4. Changed the DNL limit from  $\pm 0.25$  to  $\pm 0.35$ .
5. Added new [Figure 2-81](#).
6. Updated [Figure 2-82](#) and [Figure 2-83](#).
7. Corrected and enhanced [Table 8-2](#).

### Revision C (July 2012)

The following is the list of modifications:

1. Added the SC70 package option (corrected applicable information).
2. Corrected Capacitive Load (CL) for the Characterization graphs.
3. Enhanced description in [Figure 7-5](#).
4. Added [Section 8.6.3 "Footprint Compatibility with MCP40D18"](#).
5. Corrected Typical current number on first page.
6. In Electrical Specifications, clarified Interface Inactive to Interface Inactive (Static).
7. [Section 3.1 "Positive Power Supply Input \(VDD\)"](#), corrected and clarified pin description.
8. Updated [Table 7-1](#) to include columns for Serial Shift Register (SSR) value.

### Revision B (March 2012)

- General Release of this Document.

### Revision A (January 2012)

- Original Release of this Document.  
**Requires NDA.**

# MCP47DA1

## APPENDIX B: TERMINOLOGY

### B.1 Resolution

The resolution is the number of DAC output states that divide the full-scale range. For the 6-bit DAC, the resolution is  $2^6$ , meaning the DAC code ranges from 0 to 64.

### B.2 Least Significant Bit (LSb)

Normally, this is thought of as the ideal voltage difference between two successive codes. This bit has the smallest value or weight of all bits in the register.

For a given output voltage range, which is typically the voltage between the full-scale voltage and the zero-scale voltage ( $V_{OUT(FS)} - V_{OUT(ZS)}$ ), it is divided by the resolution of the device (Equation B-1).

#### EQUATION B-1: LSb VOLTAGE CALCULATION

$$V_{LSb} = \frac{V_{OUT(FS)} - V_{OUT(ZS)}}{2^N}$$

$2^N = 64$  (MCP47DA1)

### B.3 Monotonic Operation

Monotonic operation means that the device's output voltage ( $V_{OUT}$ ) increases with every one code step (LSb) change (from terminal B to terminal A). The  $V_{OUT}$  voltage ( $V_W$  voltage) is the sum of all the Step voltages plus the voltage at zero scale ( $V_{ZS}$ ). The zero-scale voltage is dependent on the resistance between the tap 0 point and the B Terminal.

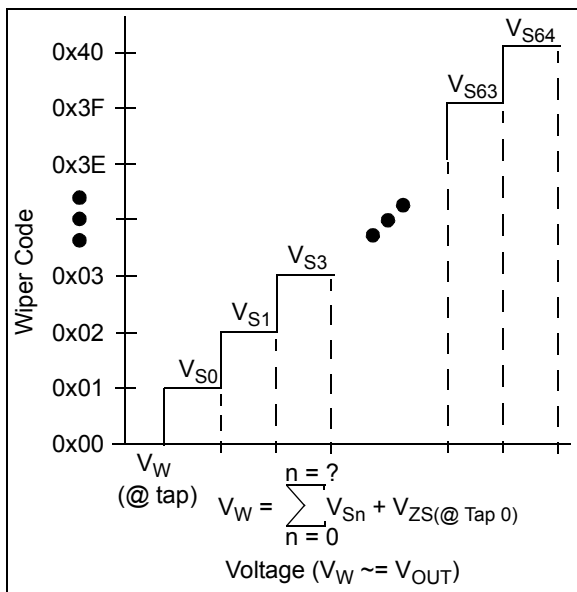


FIGURE B-1:  $V_W$  ( $V_{OUT}$ ).

### B.4 Full-Scale Error (FSE)

The Full-Scale Error (FSE) is the difference between the ideal and measured DAC output voltage with the wiper's position is set to its maximum (wiper code = 40h); see Figure B-3. Full-scale error may also be thought of as the sum of the offset error plus gain error.

See Figure 2-23 through Figure 2-33 for FSE characterization graphs.

#### EQUATION B-2: FULL-SCALE ERROR

$$FSE = \frac{V_{OUT(@FS)} - V_{IDEAL(@FS)}}{V_{LSb}}$$

Where:

- FSE is expressed in LSb
- $V_{OUT(@FS)}$  is the  $V_{OUT}$  voltage when the DAC register code is at Full Scale.
- $V_{IDEAL(@FS)}$  is the ideal output voltage when the DAC register code is at Full Scale.
- $V_{LSb}$  is the delta voltage of one DAC register code step (such as code 20h to code 21h).

### B.5 Zero-Scale Error (ZSE)

The Zero-Scale Error (ZSE) is the difference between the ideal and measured  $V_{OUT}$  voltage with the wiper position set to its minimum (wiper code = 00h); see Figure B-3. The zero-scale error is the same as the offset error for this case (wiper code = 00h).

See Figure 2-34 through Figure 2-44 for ZSE characterization graphs.

#### EQUATION B-3: ZERO-SCALE ERROR

$$ZSE = \frac{V_{OUT(@ZS)}}{V_{LSb}}$$

Where:

- FSE is expressed in LSb
- $V_{OUT(@ZS)}$  is the  $V_{OUT}$  voltage when the DAC register code is at Zero Scale.
- $V_{LSb}$  is the delta voltage of one DAC register code step (such as code 20h to code 21h).

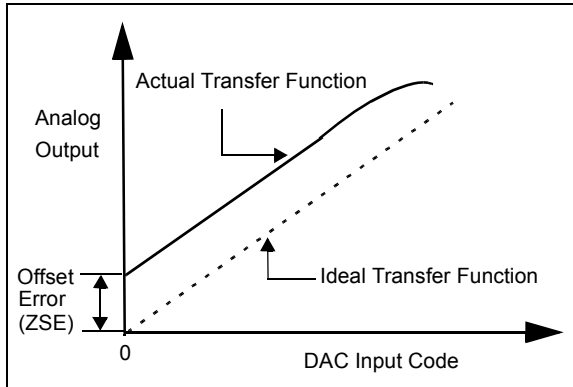
### B.6 Total Unadjusted Error

The total unadjusted error is the difference between the ideal and measured  $V_{OUT}$  voltage. Typically, calibration of the output voltage is implemented to improve system performance.

See Figure 2-45 through Figure 2-55 and Figure 2-75 through Figure 2-78 for total unadjusted error characterization graphs.

## B.7 Offset Error

The offset error (see [Figure B-2](#)) is the deviation from zero voltage output when the volatile DAC register value = 00h (zero-scale voltage). This error affects all codes by the same amount. The offset error can be calibrated by software in application circuits.



**FIGURE B-2: OFFSET ERROR.**

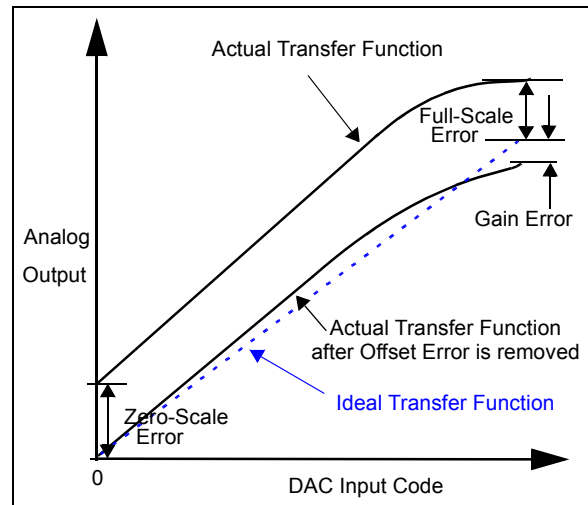
## B.8 Offset Error Drift

The offset error drift is the variation in offset error due to a change in ambient temperature. The offset error drift is typically expressed in ppm/°C.

## B.9 Gain Error

The gain error (see [Figure B-3](#)) is the difference between the actual full-scale output voltage, from the ideal output voltage of the DAC transfer curve. The gain error is calculated after nullifying the offset error, or full-scale error minus the offset error.

The gain error indicates how well the slope of the actual transfer function matches the slope of the ideal transfer function. The gain error is usually expressed as percent of full-scale range (% of FSR) or in LSB. The gain error is not calibrated at the factory and most of the gain error is contributed by the output buffer (op amp) saturation.



**FIGURE B-3: GAIN ERROR AND FULL-SCALE ERROR EXAMPLE.**

## B.10 Gain Error Drift

The gain error drift is the variation in gain error due to a change in ambient temperature. The gain error drift is typically expressed in ppm/°C.

# MCP47DA1

## B.11 Integral Nonlinearity (INL)

The integral nonlinearity (INL) error is the maximum deviation of an actual transfer function from an ideal transfer function (straight line).

In the MCP47DA1, INL is calculated using two endpoints (zero and full scale). INL can be expressed as a percentage of Full-Scale Range (FSR) or in a fraction of an LSB. INL is also called relative accuracy. Equation B-4 shows how to calculate the INL error in LSB and Figure B-4 shows an example of INL accuracy.

INL error for these devices is the maximum deviation between an actual code transition point and its corresponding ideal transition point after offset and gain errors have been removed. These endpoints are from 0x00-0x20 to 0x60-0x7F for the MCP47DA1. Refer to Figure B-4.

Positive INL means higher  $V_{OUT}$  voltage than ideal. Negative INL means lower  $V_{OUT}$  voltage than ideal.

See Figure 2-1 through Figure 2-11 and Figure 2-67 through Figure 2-70 for INL characterization graphs.

### EQUATION B-4: INL ERROR

$$INL = \frac{(V_{OUT} - V_{Ideal})}{LSb}$$

Where:  
 INL is expressed in LSB.  
 $V_{Ideal} = Code * LSB$   
 $V_{OUT} =$  The output voltage measured with a given DAC input code

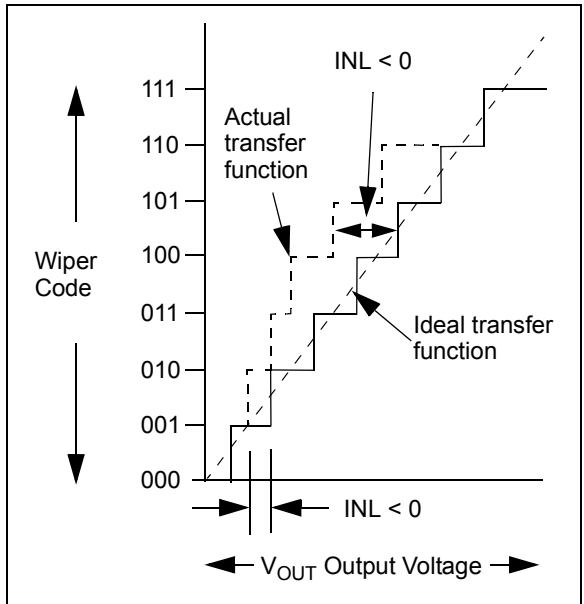


FIGURE B-4: INL ACCURACY.

## B.12 Differential Nonlinearity (DNL)

The differential nonlinearity (DNL) error (see Figure B-5) is the measure of step size between codes in actual transfer function. The ideal step size between codes is 1 LSB. A DNL error of zero would imply that every code is exactly 1 LSB wide. If the DNL error is less than 1 LSB, the DAC guarantees monotonic output and no missing codes. The DNL error between any two adjacent codes is calculated as follows:

DNL error is the measure of variations in code widths from the ideal code width. A DNL error of zero would imply that every code is exactly 1 LSB wide.

See Figure 2-12 through Figure 2-22 and Figure 2-71 through Figure 2-74 for DNL characterization graphs.

### EQUATION B-5: DNL ERROR

$$DNL = \frac{\Delta V_{OUT} - LSB}{LSb}$$

Where:  
 DNL is expressed in LSB.  
 $\Delta V_{OUT} =$  The measured DAC output voltage difference between two adjacent input codes.

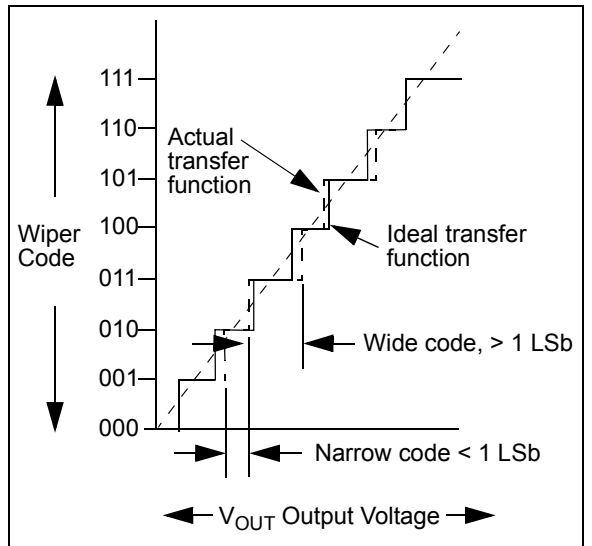


FIGURE B-5: DNL ACCURACY.

## B.13 Settling Time

The Settling time is the time delay required for the  $V_{OUT}$  voltage to settle into its new output value. This time is measured from the start of code transition, to when the  $V_{OUT}$  voltage is within the specified accuracy.

In the MCP47DA1, the settling time is a measure of the time delay until the  $V_{OUT}$  voltage reaches within 0.5 LSB of its final value, when the volatile DAC register changes from 40h to 50h.

See [Figure 2-89](#) through [Figure 2-92](#) for Settling Time oscilloscope screen captures.

## B.14 Major-Code Transition Glitch

Major-code transition glitch is the impulse energy injected into the DAC analog output when the code in the DAC register changes state. It is normally specified as the area of the glitch in nV-Sec, and is measured when the digital code is changed by 1 LSB at the major carry transition (Example: wiper code changes from "011111" to "100000", or from "100000" to "011111").

## B.15 Digital Feedthrough

The Digital feedthrough is the glitch that appears at the analog output caused by coupling from the digital input pins of the device. The area of the glitch is expressed in nV-Sec, and is measured with a full-scale change (Example: all 0s to all 1s and vice versa) on the digital input pins. The digital feedthrough is measured when the DAC is not writing to the output register.

## B.16 Power-Supply Rejection Ratio (PSRR)

PSRR indicates how the output of the DAC is affected by changes in the supply voltage. PSRR is the ratio of the change in  $V_{OUT}$  to a change in  $V_{DD}$  for full-scale output of the DAC. The  $V_{OUT}$  is measured while the  $V_{DD}$  is varied +/- 10%, and expressed in dB or  $\mu V/V$ .

## B.17 Ratiometric Temperature Coefficient

The ratiometric temperature coefficient quantifies the error in the ratio of the resistor setting (Resistance from VREF pin to wiper position ( $R_{VREF-W}$ ) and the wiper position to Ground ( $R_{W-VSS}$ ) due to temperature drift. This error also includes the drift of the output driver over temperature. This is typically the critical error when using a DAC.

See [Figure 2-56](#) through [Figure 2-66](#) for Tempco characterization graphs.

## B.18 Absolute Temperature Coefficient

The absolute temperature coefficient quantifies the error in the end-to-end output voltage (Nominal output voltage  $V_{OUT}$ ) due to temperature drift. For a DAC, this error is typically not an issue, due to the ratiometric aspect of the output.

**Note:** Due to the three resistor implementation of the MCP47DA1 ( $R1$ ,  $R_{AB}$ , and  $R2$ ),  $R1$ ,  $R_{AB}$  and  $R2$  are implemented so that they have a common tempco over-process.

# MCP47DA1

---

NOTES:



## PRODUCT IDENTIFICATION SYSTEM

To order or obtain information, e.g., on pricing or delivery, refer to the factory or the listed sales office.

| <u>PART NO.</u>                       | <u>XXX</u>  | <u>X</u>          | <u>/XX</u> |  |
|---------------------------------------|---|-------------------|------------|--|
| Device                                | I <sup>2</sup> C Slave Address  | Temperature Range | Package    |  |
| <b>Device:</b>                        | MCP47DA1: 6-bit Single DAC with I <sup>2</sup> C interface<br>MCP47DA1T: 6-bit Single DAC with I <sup>2</sup> C interface (Tape and Reel) |                   |            | <b>Examples:</b><br>a) MCP47DA1-A0E/OT: 6-bit DAC, SOT-23-6, Address = 5Ch.<br>b) MCP47DA1T-A0E/OT: 6-bit DAC, SOT-23-6, Address = 5Ch, Tape and Reel.<br>c) MCP47DA1-A1E/OT: 6-bit DAC, SOT-23-6, Address = 7Ch.<br>d) MCP47DA1T-A1E/OT: 6-bit DAC, SOT-23-6, Address = 7Ch, Tape and Reel.<br>e) MCP47DA1T-A0E/LT: 6-bit DAC, SC70-6, Address = 5Ch.<br>f) MCP47DA1T-A1E/LT: 6-bit DAC, SC70-6, Address = 7Ch. |
| <b>I<sup>2</sup>C™ Slave Address:</b> | A0 = 5Ch<br>A1 = 7Ch  |                   |            |  |
| <b>Temperature Range:</b>             | E = -40°C to +125°C   |                   |            |  |
| <b>Package:</b>                       | OT = Plastic Small Outline Transistor (SOT-23), 6-lead<br>LT = Plastic Small Outline Transistor (SC70), 6-lead                            |                   |            |  |

# MCP47DA1

---

NOTES:

---

**Note the following details of the code protection feature on Microchip devices:**

- Microchip products meet the specification contained in their particular Microchip Data Sheet.
- Microchip believes that its family of products is one of the most secure families of its kind on the market today, when used in the intended manner and under normal conditions.
- There are dishonest and possibly illegal methods used to breach the code protection feature. All of these methods, to our knowledge, require using the Microchip products in a manner outside the operating specifications contained in Microchip's Data Sheets. Most likely, the person doing so is engaged in theft of intellectual property.
- Microchip is willing to work with the customer who is concerned about the integrity of their code.
- Neither Microchip nor any other semiconductor manufacturer can guarantee the security of their code. Code protection does not mean that we are guaranteeing the product as “unbreakable.”

Code protection is constantly evolving. We at Microchip are committed to continuously improving the code protection features of our products. Attempts to break Microchip's code protection feature may be a violation of the Digital Millennium Copyright Act. If such acts allow unauthorized access to your software or other copyrighted work, you may have a right to sue for relief under that Act.

---

Information contained in this publication regarding device applications and the like is provided only for your convenience and may be superseded by updates. It is your responsibility to ensure that your application meets with your specifications. MICROCHIP MAKES NO REPRESENTATIONS OR WARRANTIES OF ANY KIND WHETHER EXPRESS OR IMPLIED, WRITTEN OR ORAL, STATUTORY OR OTHERWISE, RELATED TO THE INFORMATION, INCLUDING BUT NOT LIMITED TO ITS CONDITION, QUALITY, PERFORMANCE, MERCHANTABILITY OR FITNESS FOR PURPOSE. Microchip disclaims all liability arising from this information and its use. Use of Microchip devices in life support and/or safety applications is entirely at the buyer's risk, and the buyer agrees to defend, indemnify and hold harmless Microchip from any and all damages, claims, suits, or expenses resulting from such use. No licenses are conveyed, implicitly or otherwise, under any Microchip intellectual property rights.

#### **Trademarks**

The Microchip name and logo, the Microchip logo, dsPIC, FlashFlex, KEELOQ, KEELOQ logo, MPLAB, PIC, PICmicro, PICSTART, PIC<sup>32</sup> logo, rPIC, SST, SST Logo, SuperFlash and UNI/O are registered trademarks of Microchip Technology Incorporated in the U.S.A. and other countries.

FilterLab, Hampshire, HI-TECH C, Linear Active Thermistor, MTP, SEEVAL and The Embedded Control Solutions Company are registered trademarks of Microchip Technology Incorporated in the U.S.A.

Silicon Storage Technology is a registered trademark of Microchip Technology Inc. in other countries.

Analog-for-the-Digital Age, Application Maestro, BodyCom, chipKIT, chipKIT logo, CodeGuard, dsPICDEM, dsPICDEM.net, dsPICworks, dsSPEAK, ECAN, ECONOMONITOR, FanSense, HI-TIDE, In-Circuit Serial Programming, ICSP, Mindi, MiWi, MPASM, MPF, MPLAB Certified logo, MPLIB, MPLINK, mTouch, Omniclient Code Generation, PICC, PICC-18, PICDEM, PICDEM.net, PICkit, PICtail, REAL ICE, rFLAB, Select Mode, SQI, Serial Quad I/O, Total Endurance, TSHARC, UniWinDriver, WiperLock, ZENA and Z-Scale are trademarks of Microchip Technology Incorporated in the U.S.A. and other countries.

SQTP is a service mark of Microchip Technology Incorporated in the U.S.A.

GestIC and ULPP are registered trademarks of Microchip Technology Germany II GmbH & Co. KG, a subsidiary of Microchip Technology Inc., in other countries.

All other trademarks mentioned herein are property of their respective companies.

© 2012-2013, Microchip Technology Incorporated, Printed in the U.S.A., All Rights Reserved.

 Printed on recycled paper.

ISBN: 9781620770900

**QUALITY MANAGEMENT SYSTEM**  
**CERTIFIED BY DNV**  
**== ISO/TS 16949 ==**

*Microchip received ISO/TS-16949:2009 certification for its worldwide headquarters, design and wafer fabrication facilities in Chandler and Tempe, Arizona; Gresham, Oregon and design centers in California and India. The Company's quality system processes and procedures are for its PIC<sup>®</sup> MCUs and dsPIC<sup>®</sup> DSCs, KEELOQ<sup>®</sup> code hopping devices, Serial EEPROMs, microperipherals, nonvolatile memory and analog products. In addition, Microchip's quality system for the design and manufacture of development systems is ISO 9001:2000 certified.*



# MICROCHIP

## Worldwide Sales and Service

### AMERICAS

**Corporate Office**  
2355 West Chandler Blvd.  
Chandler, AZ 85224-6199  
Tel: 480-792-7200  
Fax: 480-792-7277  
Technical Support:  
<http://www.microchip.com/support>  
Web Address:  
[www.microchip.com](http://www.microchip.com)

**Atlanta**  
Duluth, GA  
Tel: 678-957-9614  
Fax: 678-957-1455

**Boston**  
Westborough, MA  
Tel: 774-760-0087  
Fax: 774-760-0088

**Chicago**  
Itasca, IL  
Tel: 630-285-0071  
Fax: 630-285-0075

**Cleveland**  
Independence, OH  
Tel: 216-447-0464  
Fax: 216-447-0643

**Dallas**  
Addison, TX  
Tel: 972-818-7423  
Fax: 972-818-2924

**Detroit**  
Farmington Hills, MI  
Tel: 248-538-2250  
Fax: 248-538-2260

**Indianapolis**  
Noblesville, IN  
Tel: 317-773-8323  
Fax: 317-773-5453

**Los Angeles**  
Mission Viejo, CA  
Tel: 949-462-9523  
Fax: 949-462-9608

**Santa Clara**  
Santa Clara, CA  
Tel: 408-961-6444  
Fax: 408-961-6445

**Toronto**  
Mississauga, Ontario,  
Canada  
Tel: 905-673-0699  
Fax: 905-673-6509

### ASIA/PACIFIC

**Asia Pacific Office**  
Suites 3707-14, 37th Floor  
Tower 6, The Gateway  
Harbour City, Kowloon  
Hong Kong  
Tel: 852-2401-1200  
Fax: 852-2401-3431

**Australia - Sydney**  
Tel: 61-2-9868-6733  
Fax: 61-2-9868-6755

**China - Beijing**  
Tel: 86-10-8569-7000  
Fax: 86-10-8528-2104

**China - Chengdu**  
Tel: 86-28-8665-5511  
Fax: 86-28-8665-7889

**China - Chongqing**  
Tel: 86-23-8980-9588  
Fax: 86-23-8980-9500

**China - Hangzhou**  
Tel: 86-571-2819-3187  
Fax: 86-571-2819-3189

**China - Hong Kong SAR**  
Tel: 852-2943-5100  
Fax: 852-2401-3431

**China - Nanjing**  
Tel: 86-25-8473-2460  
Fax: 86-25-8473-2470

**China - Qingdao**  
Tel: 86-532-8502-7355  
Fax: 86-532-8502-7205

**China - Shanghai**  
Tel: 86-21-5407-5533  
Fax: 86-21-5407-5066

**China - Shenyang**  
Tel: 86-24-2334-2829  
Fax: 86-24-2334-2393

**China - Shenzhen**  
Tel: 86-755-8864-2200  
Fax: 86-755-8203-1760

**China - Wuhan**  
Tel: 86-27-5980-5300  
Fax: 86-27-5980-5118

**China - Xian**  
Tel: 86-29-8833-7252  
Fax: 86-29-8833-7256

**China - Xiamen**  
Tel: 86-592-2388138  
Fax: 86-592-2388130

**China - Zhuhai**  
Tel: 86-756-3210040  
Fax: 86-756-3210049

### ASIA/PACIFIC

**India - Bangalore**  
Tel: 91-80-3090-4444  
Fax: 91-80-3090-4123

**India - New Delhi**  
Tel: 91-11-4160-8631  
Fax: 91-11-4160-8632

**India - Pune**  
Tel: 91-20-2566-1512  
Fax: 91-20-2566-1513

**Japan - Osaka**  
Tel: 81-6-6152-7160  
Fax: 81-6-6152-9310

**Japan - Tokyo**  
Tel: 81-3-6880-3770  
Fax: 81-3-6880-3771

**Korea - Daegu**  
Tel: 82-53-744-4301  
Fax: 82-53-744-4302

**Korea - Seoul**  
Tel: 82-2-554-7200  
Fax: 82-2-558-5932 or  
82-2-558-5934

**Malaysia - Kuala Lumpur**  
Tel: 60-3-6201-9857  
Fax: 60-3-6201-9859

**Malaysia - Penang**  
Tel: 60-4-227-8870  
Fax: 60-4-227-4068

**Philippines - Manila**  
Tel: 63-2-634-9065  
Fax: 63-2-634-9069

**Singapore**  
Tel: 65-6334-8870  
Fax: 65-6334-8850

**Taiwan - Hsin Chu**  
Tel: 886-3-5778-366  
Fax: 886-3-5770-955

**Taiwan - Kaohsiung**  
Tel: 886-7-213-7828  
Fax: 886-7-330-9305

**Taiwan - Taipei**  
Tel: 886-2-2508-8600  
Fax: 886-2-2508-0102

**Thailand - Bangkok**  
Tel: 66-2-694-1351  
Fax: 66-2-694-1350

### EUROPE

**Austria - Wels**  
Tel: 43-7242-2244-39  
Fax: 43-7242-2244-393

**Denmark - Copenhagen**  
Tel: 45-4450-2828  
Fax: 45-4485-2829

**France - Paris**  
Tel: 33-1-69-53-63-20  
Fax: 33-1-69-30-90-79

**Germany - Munich**  
Tel: 49-89-627-144-0  
Fax: 49-89-627-144-44

**Italy - Milan**  
Tel: 39-0331-742611  
Fax: 39-0331-466781

**Netherlands - Drunen**  
Tel: 31-416-690399  
Fax: 31-416-690340

**Spain - Madrid**  
Tel: 34-91-708-08-90  
Fax: 34-91-708-08-91

**UK - Wokingham**  
Tel: 44-118-921-5869  
Fax: 44-118-921-5820

11/29/12