



Dual N-Channel 30 V (D-S) MOSFETs

| PRODUCT SUMMARY | | | | |
|-----------------|---------------------|-----------------------------------|--------------------|-----------------------|
| | V _{DS} (V) | R _{DS(on)} (Ω) (Max.) | I _D (A) | Q _g (Typ.) |
| Channel-1 | 30 | 0.0120 at V _{GS} = 10 V | 16 ^a | 6.8 nC |
| | | 0.0145 at V _{GS} = 4.5 V | 16 ^a | |
| Channel-2 | 30 | 0.0037 at V _{GS} = 10 V | 28 ^a | 32 nC |
| | | 0.0045 at V _{GS} = 4.5 V | 28 ^a | |

FEATURES

- TrenchFET[®] Power MOSFETs
- 100 % R_g and UIS Tested
- Material categorization:
For definitions of compliance please see www.vishay.com/doc?99912

APPLICATIONS

- Notebook System Power
- POL
- Synchronous Buck Converter



RoHS
COMPLIANT
HALOGEN
FREE

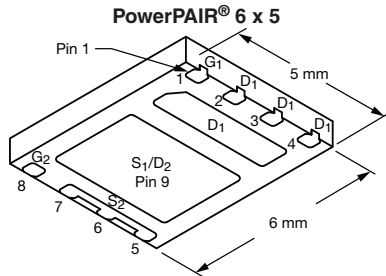

Ordering Information: SiZ918DT-T1-GE3 (Lead (Pb)-free and Halogen-free)

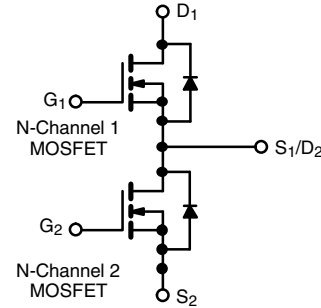

| ABSOLUTE MAXIMUM RATINGS (T _A = 25 °C, unless otherwise noted) | | | | | |
|---|-----------------------------------|------------------------|----------------------|-----------------------|-----------------|
| Parameter | Symbol | Channel-1 | Channel-2 | Unit | |
| Drain-Source Voltage | V _{DS} | 30 | | V | |
| Gate-Source Voltage | V _{GS} | ± 20 | | | |
| Continuous Drain Current (T _J = 150 °C) | I _D | T _C = 25 °C | 16 ^a | 28 ^a | A |
| | | T _C = 70 °C | 16 ^a | 28 ^a | |
| | | T _A = 25 °C | 14.3 ^{b, c} | 26 ^{a, b, c} | |
| | | T _A = 70 °C | 11.4 ^{b, c} | 21 ^{a, b, c} | |
| Pulsed Drain Current (t = 300 μs) | I _{DM} | 50 | 110 | A | |
| Continuous Source Drain Diode Current | I _S | T _C = 25 °C | 16 ^a | | 28 ^a |
| | | T _A = 25 °C | 3.4 ^{b, c} | 4.3 ^{b, c} | |
| Single Pulse Avalanche Current | L = 0.1 mH | I _{AS} | 18 | 35 | mJ |
| Single Pulse Avalanche Energy | E _{AS} | 16 | 61 | | |
| Maximum Power Dissipation | P _D | T _C = 25 °C | 29 | 100 | W |
| | | T _C = 70 °C | 18 | 64 | |
| | | T _A = 25 °C | 4.2 ^{b, c} | 5.2 ^{b, c} | |
| | | T _A = 70 °C | 2.7 ^{b, c} | 3.3 ^{b, c} | |
| Operating Junction and Storage Temperature Range | T _J , T _{stg} | - 55 to 150 | | °C | |
| Soldering Recommendations (Peak Temperature) ^{d, e} | | 260 | | | |

| THERMAL RESISTANCE RATINGS | | | | | | | |
|---|--------------|-------------------|------|-----------|------|------|------|
| Parameter | Symbol | Channel-1 | | Channel-2 | | Unit | |
| | | Typ. | Max. | Typ. | Max. | | |
| Maximum Junction-to-Ambient ^{b, f} | t ≤ 10 s | R _{thJA} | 24 | 30 | 19 | 24 | °C/W |
| Maximum Junction-to-Case (Drain) | Steady State | R _{thJC} | 3.4 | 4.3 | 1 | 1.25 | |

Notes:

- Package limited.
- Surface mounted on 1" x 1" FR4 board.
- t = 10 s.
- See solder profile (www.vishay.com/doc?73257). The PowerPAIR is a leadless package. The end of the lead terminal is exposed copper (not plated) as a result of the singulation process in manufacturing. A solder fillet at the exposed copper tip cannot be guaranteed and is not required to ensure adequate bottom side solder interconnection.
- Rework conditions: manual soldering with a soldering iron is not recommended for leadless components.
- Maximum under steady state conditions is 65 °C/W for channel-1 and 55 °C/W for channel-2.

| SPECIFICATIONS ($T_J = 25\text{ }^\circ\text{C}$, unless otherwise noted) | | | | | | | | | |
|---|-------------------------|---|--|------|--------|----------------------|---------------|-----|----------|
| Parameter | Symbol | Test Conditions | Min. | Typ. | Max. | Unit | | | |
| Static | | | | | | | | | |
| Drain-Source Breakdown Voltage | V_{DS} | $V_{GS} = 0\text{ V}, I_D = 250\text{ }\mu\text{A}$ | Ch-1 | 30 | | V | | | |
| | | $V_{GS} = 0\text{ V}, I_D = 250\text{ }\mu\text{A}$ | Ch-2 | 30 | | | | | |
| V_{DS} Temperature Coefficient | $\Delta V_{DS}/T_J$ | $I_D = 250\text{ }\mu\text{A}$ | Ch-1 | | 33 | mV/ $^\circ\text{C}$ | | | |
| | | $I_D = 250\text{ }\mu\text{A}$ | Ch-2 | | 37 | | | | |
| $V_{GS(th)}$ Temperature Coefficient | $\Delta V_{GS(th)}/T_J$ | $I_D = 250\text{ }\mu\text{A}$ | Ch-1 | | - 5 | | | | |
| | | $I_D = 250\text{ }\mu\text{A}$ | Ch-2 | | - 7.5 | | | | |
| Gate Threshold Voltage | $V_{GS(th)}$ | $V_{DS} = V_{GS}, I_D = 250\text{ }\mu\text{A}$ | Ch-1 | 1 | | 2.2 | V | | |
| | | $V_{DS} = V_{GS}, I_D = 250\text{ }\mu\text{A}$ | Ch-2 | 1.2 | | 2.2 | | | |
| Gate Source Leakage | I_{GSS} | $V_{DS} = 0\text{ V}, V_{GS} = \pm 20\text{ V}$ | Ch-1 | | | ± 100 | nA | | |
| | | | Ch-2 | | | ± 100 | | | |
| Zero Gate Voltage Drain Current | I_{DSS} | $V_{DS} = 30\text{ V}, V_{GS} = 0\text{ V}$ | Ch-1 | | | 1 | μA | | |
| | | $V_{DS} = 30\text{ V}, V_{GS} = 0\text{ V}$ | Ch-2 | | | 1 | | | |
| | | $V_{DS} = 30\text{ V}, V_{GS} = 0\text{ V}, T_J = 55\text{ }^\circ\text{C}$ | Ch-1 | | | 5 | | | |
| | | $V_{DS} = 30\text{ V}, V_{GS} = 0\text{ V}, T_J = 55\text{ }^\circ\text{C}$ | Ch-2 | | | 5 | | | |
| On-State Drain Current ^b | $I_{D(on)}$ | $V_{DS} \geq 5\text{ V}, V_{GS} = 10\text{ V}$ | Ch-1 | 20 | | A | | | |
| | | $V_{DS} \geq 5\text{ V}, V_{GS} = 10\text{ V}$ | Ch-2 | 20 | | | | | |
| Drain-Source On-State Resistance ^b | $R_{DS(on)}$ | $V_{GS} = 10\text{ V}, I_D = 13.8\text{ A}$ | Ch-1 | | 0.0100 | 0.0120 | Ω | | |
| | | $V_{GS} = 10\text{ V}, I_D = 20\text{ A}$ | Ch-2 | | 0.0030 | 0.0037 | | | |
| | | $V_{GS} = 4.5\text{ V}, I_D = 12.6\text{ A}$ | Ch-1 | | 0.0120 | 0.0145 | | | |
| | | $V_{GS} = 4.5\text{ V}, I_D = 20\text{ A}$ | Ch-2 | | 0.0035 | 0.0045 | | | |
| Forward Transconductance ^b | g_{fs} | $V_{DS} = 10\text{ V}, I_D = 13.8\text{ A}$ | Ch-1 | | 47 | S | | | |
| | | $V_{DS} = 10\text{ V}, I_D = 20\text{ A}$ | Ch-2 | | 116 | | | | |
| Dynamic^a | | | | | | | | | |
| Input Capacitance | C_{iss} | Channel-1 $V_{DS} = 15\text{ V}, V_{GS} = 0\text{ V}, f = 1\text{ MHz}$ | Ch-1 | | 790 | pF | | | |
| | | | Ch-2 | | 3830 | | | | |
| Output Capacitance | C_{oss} | | Ch-1 | | 190 | | | | |
| | | | Ch-2 | | 670 | | | | |
| Reverse Transfer Capacitance | C_{rss} | | Channel-2 $V_{DS} = 15\text{ V}, V_{GS} = 0\text{ V}, f = 1\text{ MHz}$ | Ch-1 | | | 76 | | |
| | | | | Ch-2 | | | 315 | | |
| Total Gate Charge | Q_g | $V_{DS} = 15\text{ V}, V_{GS} = 10\text{ V}, I_D = 13.8\text{ A}$ | | Ch-1 | | 14 | 21 | | |
| | | $V_{DS} = 15\text{ V}, V_{GS} = 10\text{ V}, I_D = 20\text{ A}$ | | Ch-2 | | 67.3 | 105 | | |
| | | Channel-1 $V_{DS} = 15\text{ V}, V_{GS} = 4.5\text{ V}, I_D = 13.8\text{ A}$ | | Ch-1 | | 6.8 | 11 | | |
| | | | | Ch-2 | | 32 | 48 | | |
| Gate-Source Charge | Q_{gs} | Channel-2 $V_{DS} = 15\text{ V}, V_{GS} = 4.5\text{ V}, I_D = 20\text{ A}$ | Ch-1 | | 2.6 | nC | | | |
| | | | Ch-2 | | 10.8 | | | | |
| Gate-Drain Charge | Q_{gd} | | Ch-1 | | 1.9 | | | | |
| | | | Ch-2 | | 9.3 | | | | |
| Gate Resistance | R_g | | $f = 1\text{ MHz}$ | Ch-1 | 0.4 | | 2 | 4 | Ω |
| | | | | Ch-2 | 0.2 | | 1.1 | 2.2 | |

Notes:

- a. Guaranteed by design, not subject to production testing.
b. Pulse test; pulse width $\leq 300\text{ }\mu\text{s}$, duty cycle $\leq 2\%$.



| SPECIFICATIONS ($T_J = 25\text{ }^\circ\text{C}$, unless otherwise noted) | | | | | | | |
|--|--------------|---|------|------|------|------|----|
| Parameter | Symbol | Test Conditions | Min. | Typ. | Max. | Unit | |
| Dynamic^a | | | | | | | |
| Turn-On Delay Time | $t_{d(on)}$ | Channel-1 $V_{DD} = 15\text{ V}$, $R_L = 1.5\ \Omega$ $I_D \cong 10\text{ A}$, $V_{GEN} = 4.5\text{ V}$, $R_g = 1\ \Omega$ | Ch-1 | | 15 | 30 | ns |
| Rise Time | t_r | | Ch-2 | | 30 | 60 | |
| Turn-Off Delay Time | $t_{d(off)}$ | Channel-2 $V_{DD} = 15\text{ V}$, $R_L = 1.5\ \Omega$ $I_D \cong 10\text{ A}$, $V_{GEN} = 4.5\text{ V}$, $R_g = 1\ \Omega$ | Ch-1 | | 12 | 20 | |
| | | | Ch-2 | | 33 | 65 | |
| Fall Time | t_f | Channel-1 $V_{DD} = 15\text{ V}$, $R_L = 1.5\ \Omega$ $I_D \cong 10\text{ A}$, $V_{GEN} = 4.5\text{ V}$, $R_g = 1\ \Omega$ | Ch-1 | | 20 | 40 | |
| | | | Ch-2 | | 40 | 80 | |
| Turn-On Delay Time | $t_{d(on)}$ | Channel-2 $V_{DD} = 15\text{ V}$, $R_L = 1.5\ \Omega$ $I_D \cong 10\text{ A}$, $V_{GEN} = 4.5\text{ V}$, $R_g = 1\ \Omega$ | Ch-1 | | 10 | 20 | |
| | | | Ch-2 | | 12 | 25 | |
| Rise Time | t_r | Channel-1 $V_{DD} = 15\text{ V}$, $R_L = 1.5\ \Omega$ $I_D \cong 10\text{ A}$, $V_{GEN} = 10\text{ V}$, $R_g = 1\ \Omega$ | Ch-1 | | 10 | 20 | |
| | | | Ch-2 | | 15 | 30 | |
| Turn-Off Delay Time | $t_{d(off)}$ | Channel-2 $V_{DD} = 15\text{ V}$, $R_L = 1.5\ \Omega$ $I_D \cong 10\text{ A}$, $V_{GEN} = 10\text{ V}$, $R_g = 1\ \Omega$ | Ch-1 | | 12 | 20 | |
| | | | Ch-2 | | 22 | 25 | |
| Fall Time | t_f | Channel-1 $V_{DD} = 15\text{ V}$, $R_L = 1.5\ \Omega$ $I_D \cong 10\text{ A}$, $V_{GEN} = 10\text{ V}$, $R_g = 1\ \Omega$ | Ch-1 | | 20 | 40 | |
| | | | Ch-2 | | 40 | 80 | |
| Drain-Source Body Diode Characteristics | | | | | | | |
| Continuous Source-Drain Diode Current | I_S | $T_C = 25\text{ }^\circ\text{C}$ | Ch-1 | | | 16 | A |
| | | | Ch-2 | | | 28 | |
| Pulse Diode Forward Current ^a | I_{SM} | | Ch-1 | | | 50 | |
| | | | Ch-2 | | | 110 | |
| Body Diode Voltage | V_{SD} | $I_S = 10\text{ A}$, $V_{GS} = 0\text{ V}$ | Ch-1 | | 0.85 | 1.2 | V |
| | | | Ch-2 | | 0.8 | 1.2 | |
| Body Diode Reverse Recovery Time | t_{rr} | Channel-1 $I_F = 10\text{ A}$, $di/dt = 100\text{ A}/\mu\text{s}$, $T_J = 25\text{ }^\circ\text{C}$ | Ch-1 | | 20 | 40 | ns |
| | | | Ch-2 | | 30 | 60 | |
| Body Diode Reverse Recovery Charge | Q_{rr} | Channel-2 $I_F = 10\text{ A}$, $di/dt = 100\text{ A}/\mu\text{s}$, $T_J = 25\text{ }^\circ\text{C}$ | Ch-1 | | 10 | 20 | nC |
| | | | Ch-2 | | 21 | 40 | |
| Reverse Recovery Fall Time | t_a | | Ch-1 | | 11 | | ns |
| | | | Ch-2 | | 17 | | |
| Reverse Recovery Rise Time | t_b | | Ch-1 | | 9 | | |
| | | | Ch-2 | | 13 | | |

Notes:

- a. Guaranteed by design, not subject to production testing.
 b. Pulse test; pulse width $\leq 300\ \mu\text{s}$, duty cycle $\leq 2\%$.

Stresses beyond those listed under "Absolute Maximum Ratings" may cause permanent damage to the device. These are stress ratings only, and functional operation of the device at these or any other conditions beyond those indicated in the operational sections of the specifications is not implied. Exposure to absolute maximum rating conditions for extended periods may affect device reliability.

SiZ918DT

Vishay Siliconix



CHANNEL-1 TYPICAL CHARACTERISTICS (25 °C, unless otherwise noted)

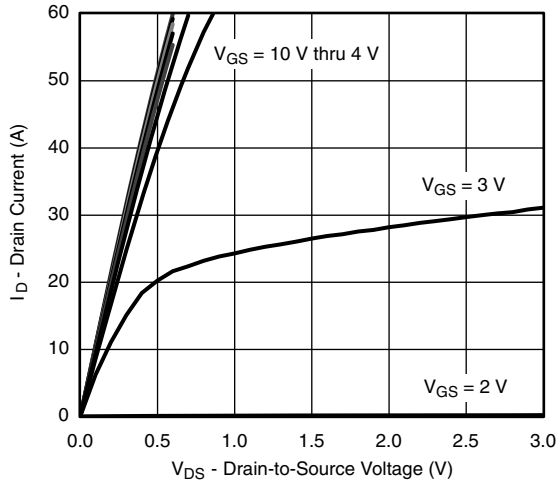

Output Characteristics

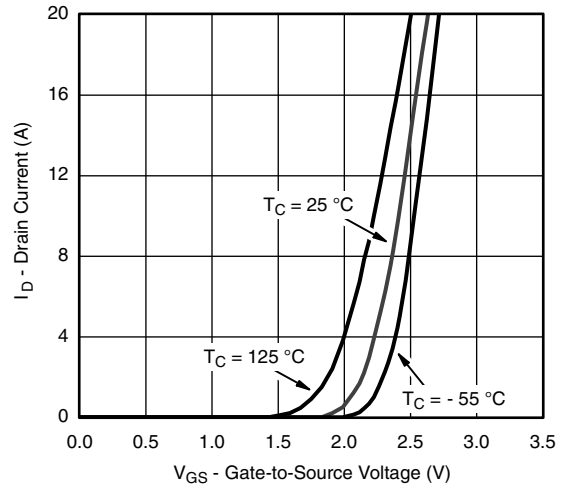

Transfer Characteristics

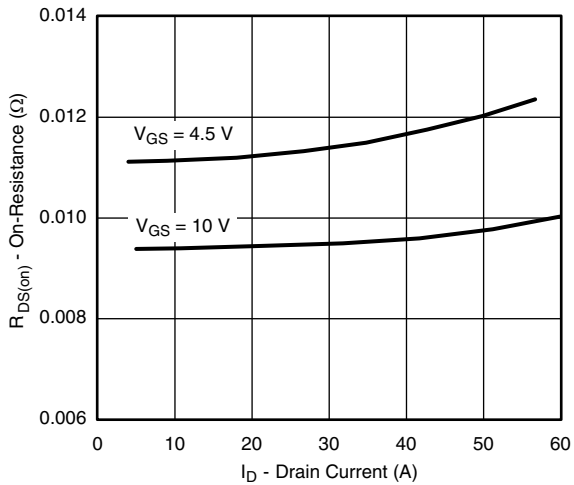

On-Resistance vs. Drain Current

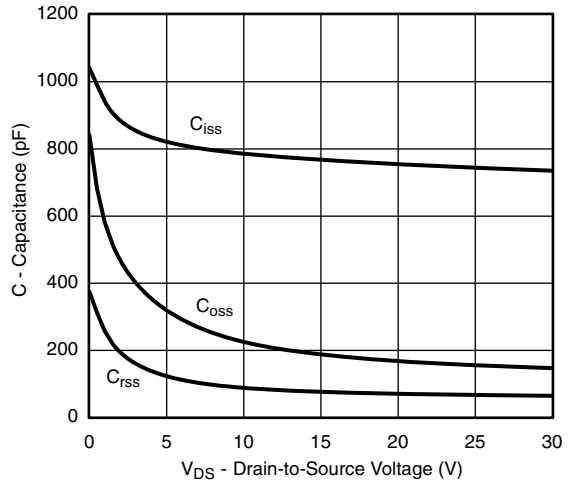

Capacitance

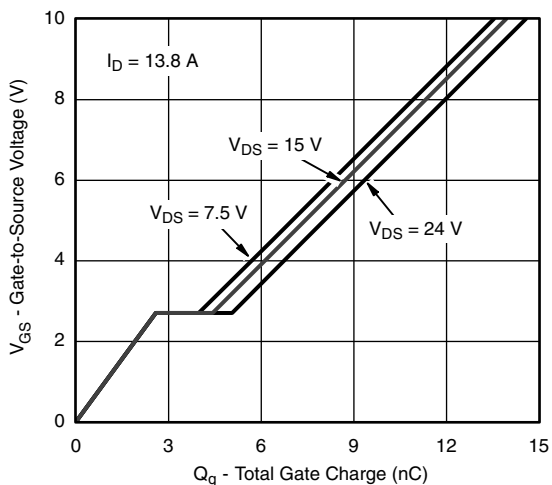

Gate Charge

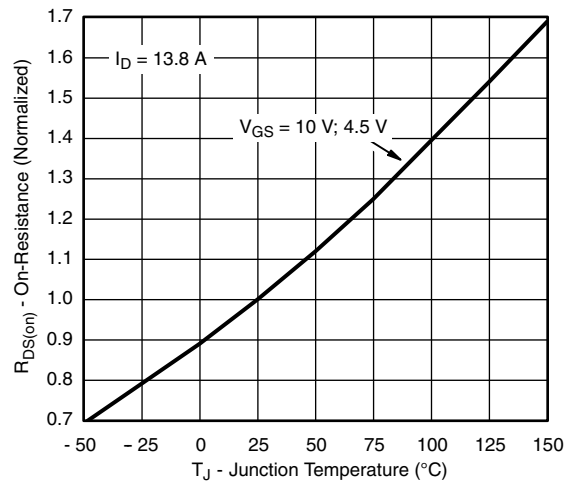

On-Resistance vs. Junction Temperature



CHANNEL-1 TYPICAL CHARACTERISTICS (25 °C, unless otherwise noted)

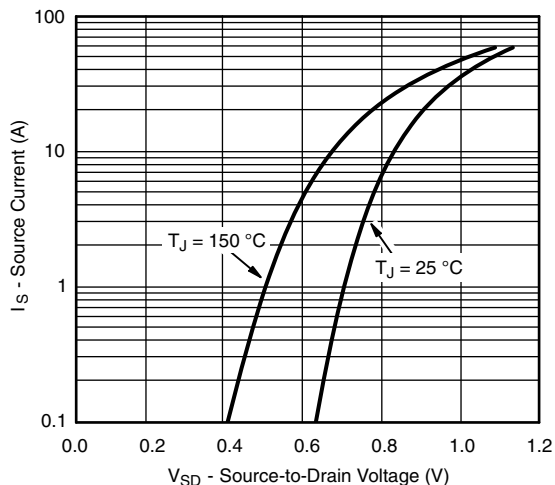

Source-Drain Diode Forward Voltage

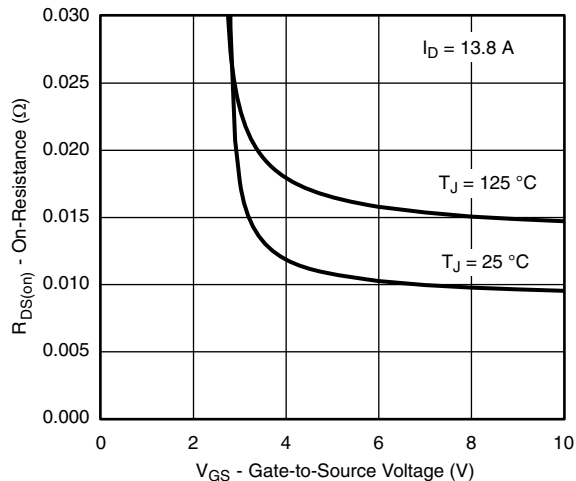

On-Resistance vs. Gate-to-Source Voltage

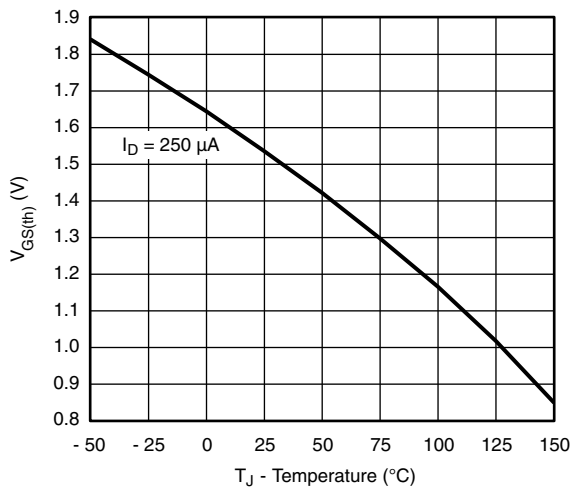

Threshold Voltage

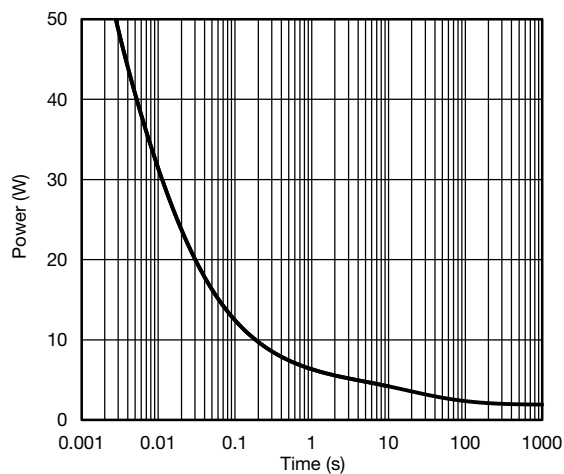

Single Pulse Power

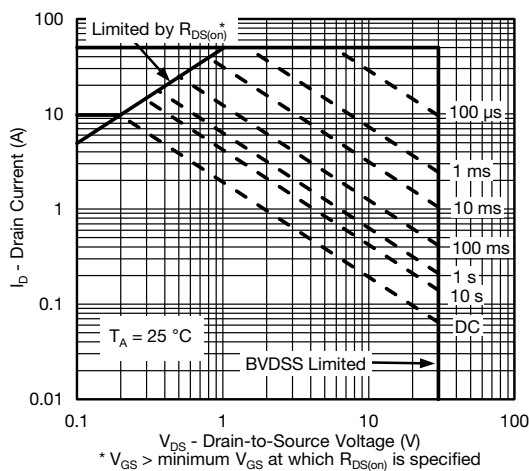

Safe Operating Area, Junction-to-Ambient



CHANNEL-1 TYPICAL CHARACTERISTICS (25 °C, unless otherwise noted)

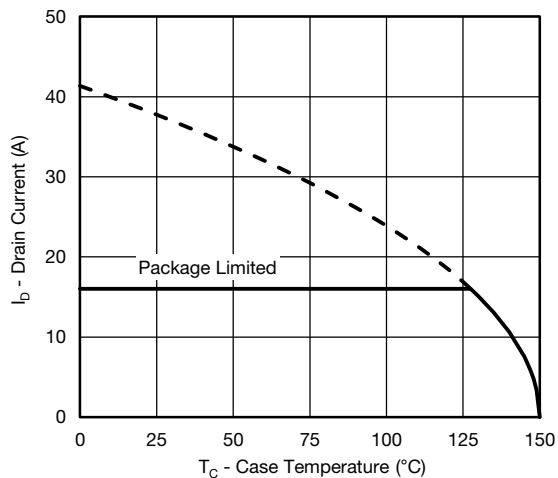

Current Derating*

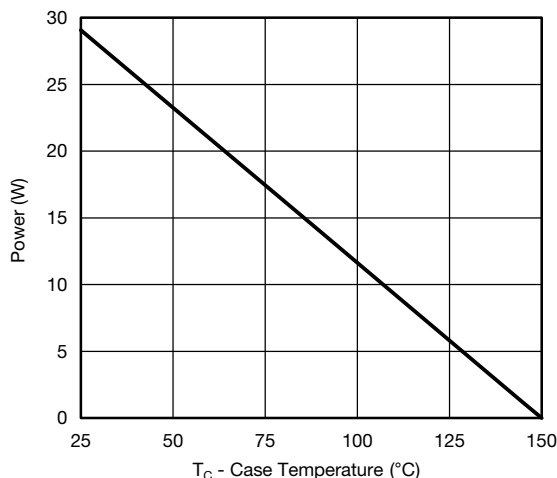

Power, Junction-to-Case

* The power dissipation P_D is based on $T_{J(max)} = 150$ °C, using junction-to-case thermal resistance, and is more useful in settling the upper dissipation limit for cases where additional heatsinking is used. It is used to determine the current rating, when this rating falls below the package limit.



CHANNEL-1 TYPICAL CHARACTERISTICS (25 °C, unless otherwise noted)

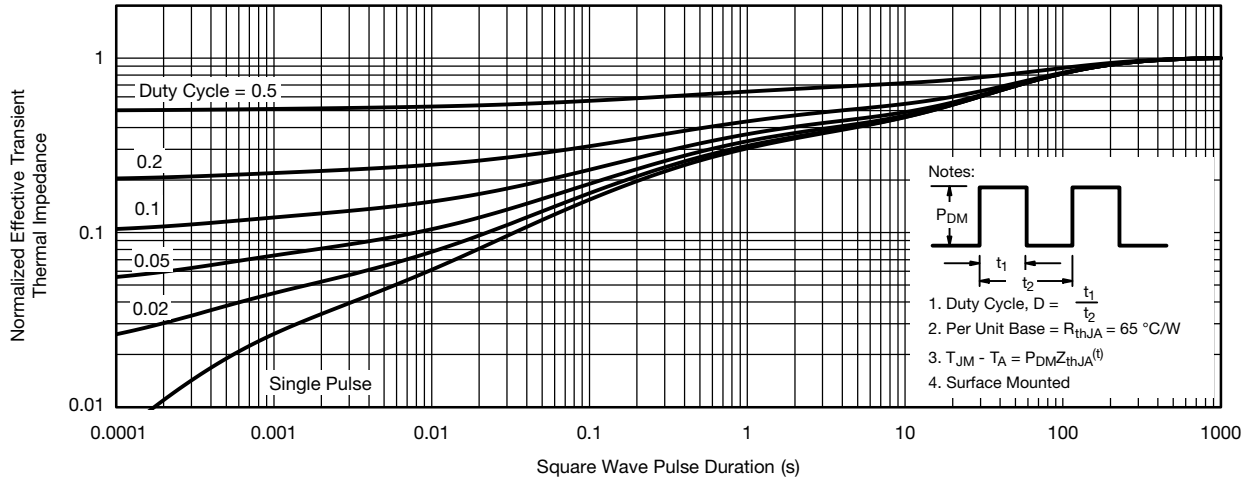

Normalized Thermal Transient Impedance, Junction-to-Ambient

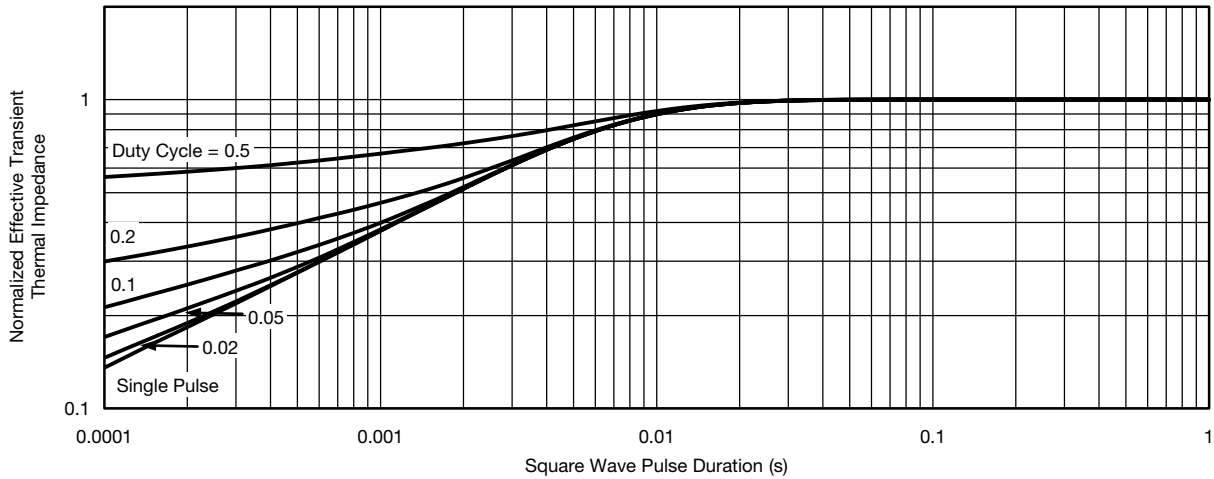

Normalized Thermal Transient Impedance, Junction-to-Case

SiZ918DT

Vishay Siliconix



CHANNEL-2 TYPICAL CHARACTERISTICS (25 °C, unless otherwise noted)

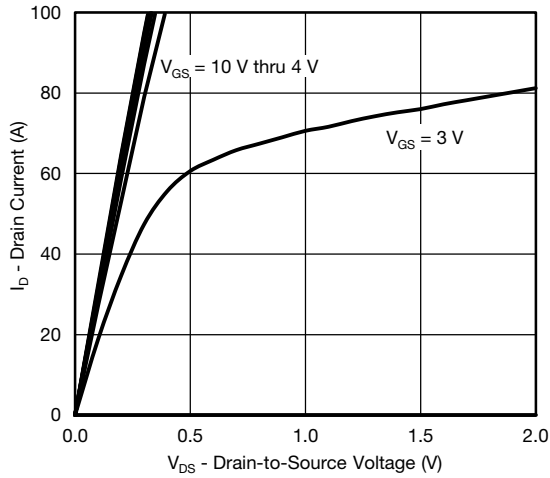

Output Characteristics

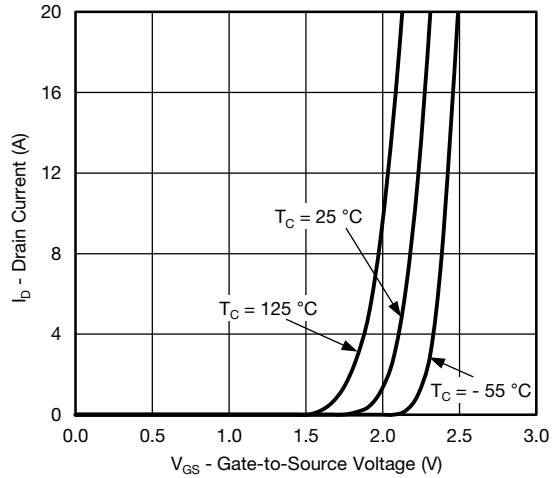

Transfer Characteristics

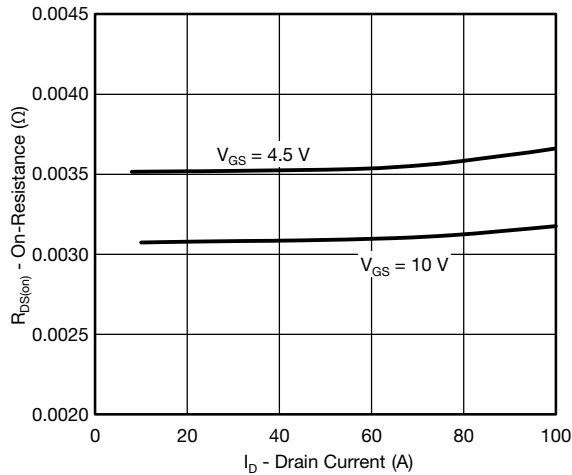

On-Resistance vs. Drain Current

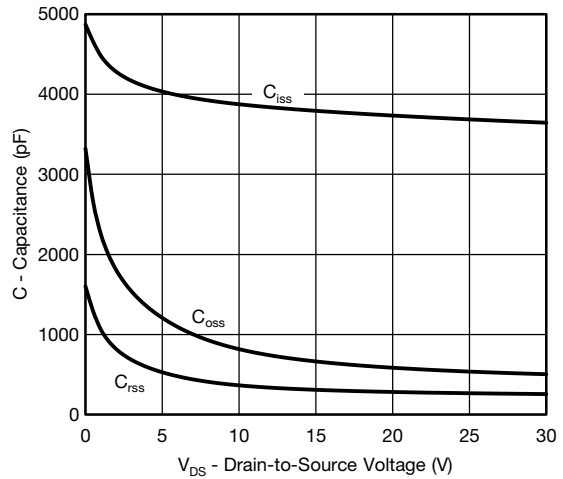

Capacitance

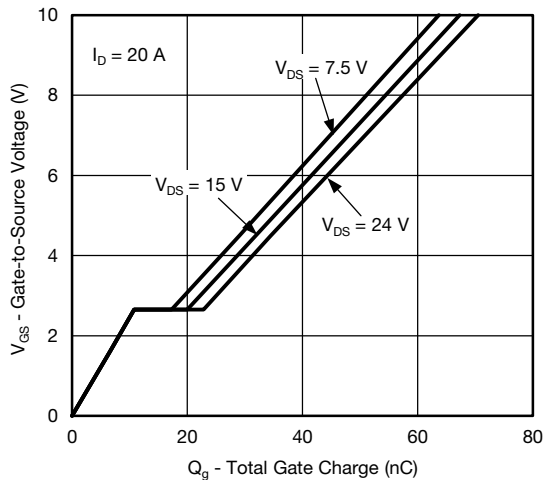

Gate Charge

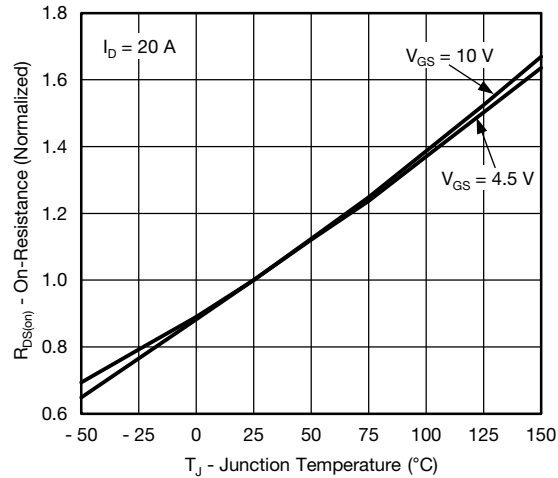

On-Resistance vs. Junction Temperature



CHANNEL-2 TYPICAL CHARACTERISTICS (25 °C, unless otherwise noted)

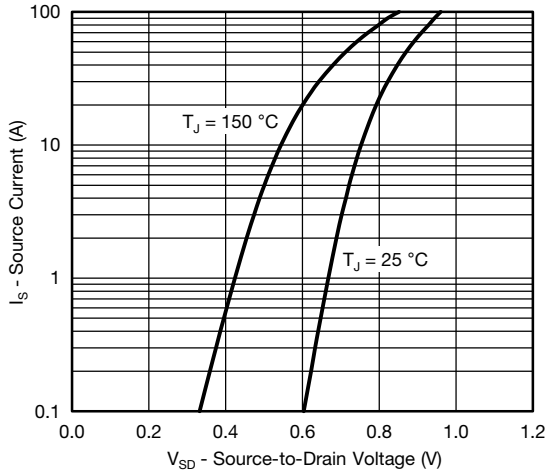

Source-Drain Diode Forward Voltage

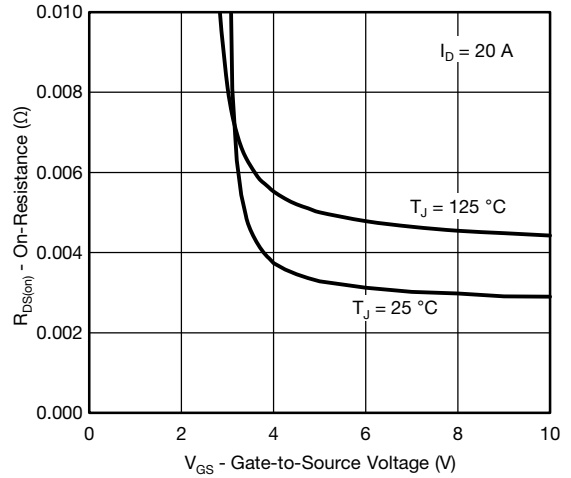

On-Resistance vs. Gate-to-Source Voltage

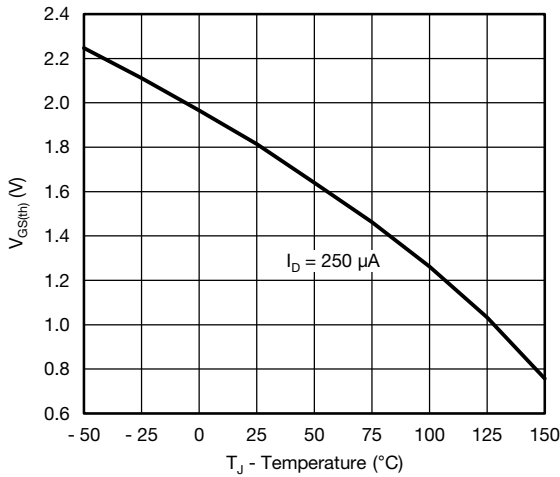

Threshold Voltage

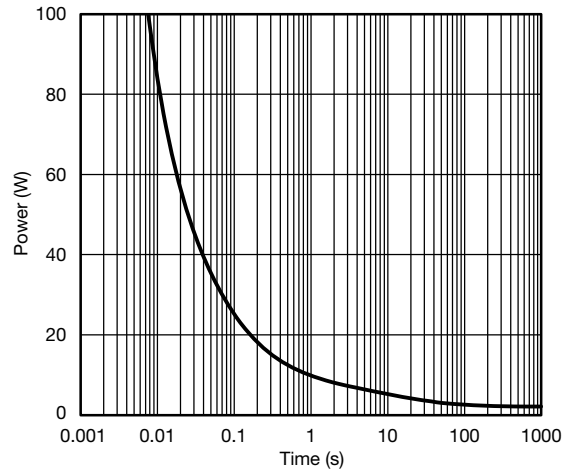

Single Pulse Power

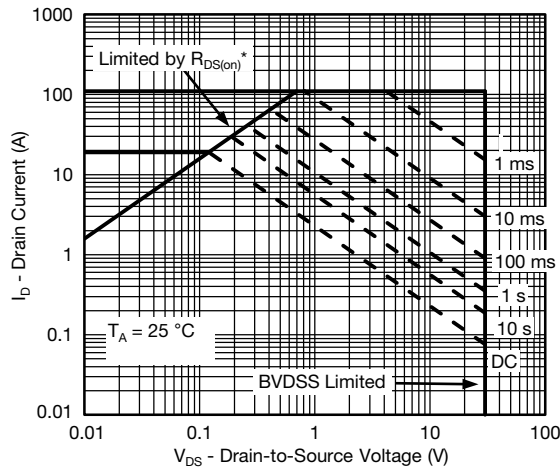

* $V_{GS} >$ minimum V_{GS} at which $R_{DS(on)}$ is specified
Safe Operating Area, Junction-to-Ambient



CHANNEL-2 TYPICAL CHARACTERISTICS (25 °C, unless otherwise noted)

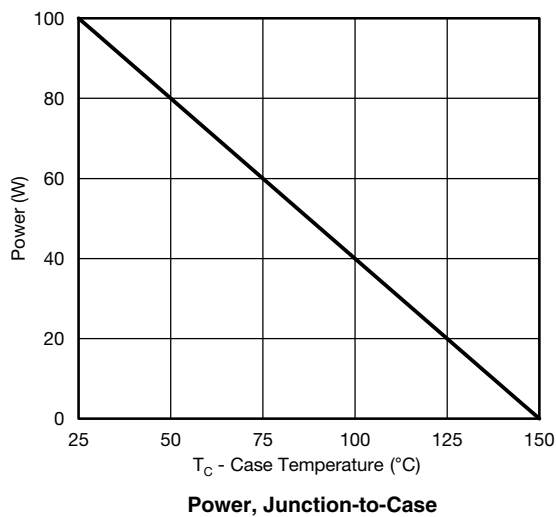
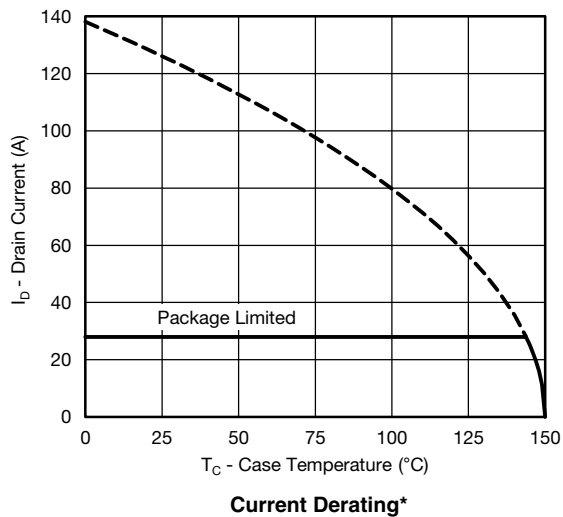

* The power dissipation P_D is based on $T_{J(max.)} = 150$ °C, using junction-to-case thermal resistance, and is more useful in settling the upper dissipation limit for cases where additional heatsinking is used. It is used to determine the current rating, when this rating falls below the package limit.



CHANNEL-2 TYPICAL CHARACTERISTICS (25 °C, unless otherwise noted)

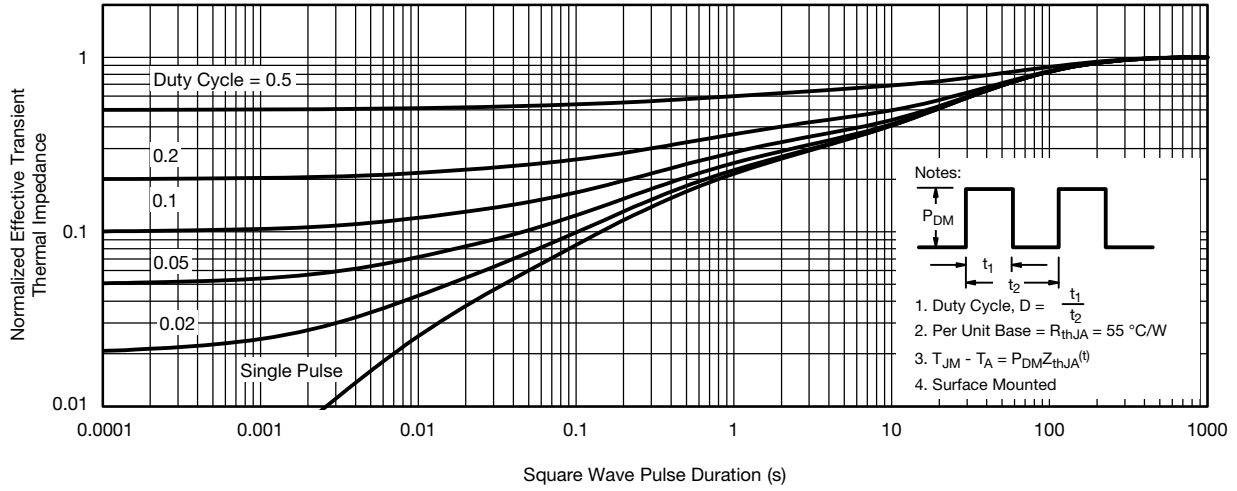

Normalized Thermal Transient Impedance, Junction-to-Ambient

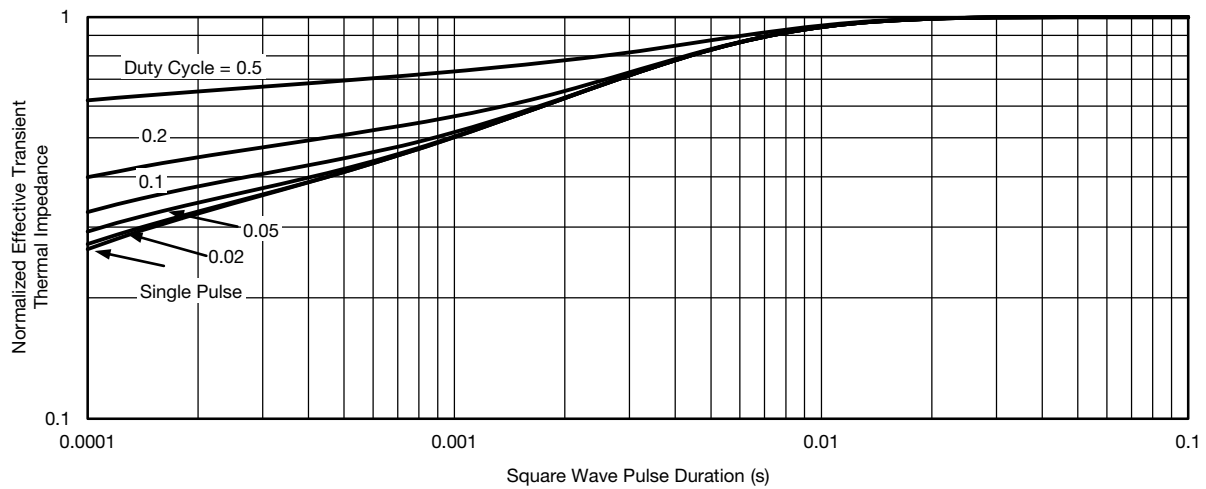

Normalized Thermal Transient Impedance, Junction-to-Case

Vishay Siliconix maintains worldwide manufacturing capability. Products may be manufactured at one of several qualified locations. Reliability data for Silicon Technology and Package Reliability represent a composite of all qualified locations. For related documents such as package/tape drawings, part marking, and reliability data, see www.vishay.com/ppg?63783.

PowerPAIR® 6 x 5 Case Outline



Top side view

Back side view

| DIM. | MILLIMETERS | | | INCHES | | |
|---------------------------------|-------------|------|------|------------|-------|-------|
| | MIN. | NOM. | MAX. | MIN. | NOM. | MAX. |
| A | 0.70 | 0.75 | 0.80 | 0.028 | 0.030 | 0.032 |
| A1 | 0.00 | - | 0.10 | 0.000 | - | 0.004 |
| A3 | 0.15 | 0.20 | 0.25 | 0.006 | 0.007 | 0.009 |
| b | 0.43 | 0.51 | 0.61 | 0.017 | 0.020 | 0.024 |
| b1 | 0.25 BSC | | | 0.010 BSC | | |
| D | 4.90 | 5.00 | 5.10 | 0.192 | 0.196 | 0.200 |
| D1 | 3.75 | 3.80 | 3.85 | 0.148 | 0.150 | 0.152 |
| E | 5.90 | 6.00 | 6.10 | 0.232 | 0.236 | 0.240 |
| E1 Option AA (for W/B) | 2.62 | 2.67 | 2.72 | 0.103 | 0.105 | 0.107 |
| E1 Option AB (for BWL) | 2.42 | 2.47 | 2.52 | 0.095 | 0.097 | 0.099 |
| E2 | 0.87 | 0.92 | 0.97 | 0.034 | 0.036 | 0.038 |
| e | 1.27 BSC | | | 0.050 BSC | | |
| K Option AA (for W/B) | 0.45 typ. | | | 0.018 typ. | | |
| K Option AB (for BWL) | 0.65 typ. | | | 0.025 typ. | | |
| K1 | 0.66 typ. | | | 0.025 typ. | | |
| L | 0.33 | 0.43 | 0.53 | 0.013 | 0.017 | 0.020 |
| L3 | 0.23 BSC | | | 0.009 BSC | | |
| z | 0.34 BSC | | | 0.013 BSC | | |
| ECN: T14-0782-Rev. C, 22-Dec-14 | | | | | | |
| DWG: 6005 | | | | | | |

Recommended Minimum PAD for PowerPAIR® 6 x 5



Dimensions in millimeters (inch)

Note

- Linear dimensions are in black, the same information is provided in ordinate dimensions which are in blue.



Disclaimer

ALL PRODUCT, PRODUCT SPECIFICATIONS AND DATA ARE SUBJECT TO CHANGE WITHOUT NOTICE TO IMPROVE RELIABILITY, FUNCTION OR DESIGN OR OTHERWISE.

Vishay Intertechnology, Inc., its affiliates, agents, and employees, and all persons acting on its or their behalf (collectively, "Vishay"), disclaim any and all liability for any errors, inaccuracies or incompleteness contained in any datasheet or in any other disclosure relating to any product.

Vishay makes no warranty, representation or guarantee regarding the suitability of the products for any particular purpose or the continuing production of any product. To the maximum extent permitted by applicable law, Vishay disclaims (i) any and all liability arising out of the application or use of any product, (ii) any and all liability, including without limitation special, consequential or incidental damages, and (iii) any and all implied warranties, including warranties of fitness for particular purpose, non-infringement and merchantability.

Statements regarding the suitability of products for certain types of applications are based on Vishay's knowledge of typical requirements that are often placed on Vishay products in generic applications. Such statements are not binding statements about the suitability of products for a particular application. It is the customer's responsibility to validate that a particular product with the properties described in the product specification is suitable for use in a particular application. Parameters provided in datasheets and/or specifications may vary in different applications and performance may vary over time. All operating parameters, including typical parameters, must be validated for each customer application by the customer's technical experts. Product specifications do not expand or otherwise modify Vishay's terms and conditions of purchase, including but not limited to the warranty expressed therein.

Except as expressly indicated in writing, Vishay products are not designed for use in medical, life-saving, or life-sustaining applications or for any other application in which the failure of the Vishay product could result in personal injury or death. Customers using or selling Vishay products not expressly indicated for use in such applications do so at their own risk. Please contact authorized Vishay personnel to obtain written terms and conditions regarding products designed for such applications.

No license, express or implied, by estoppel or otherwise, to any intellectual property rights is granted by this document or by any conduct of Vishay. Product names and markings noted herein may be trademarks of their respective owners.

Material Category Policy

Vishay Intertechnology, Inc. hereby certifies that all its products that are identified as RoHS-Compliant fulfill the definitions and restrictions defined under Directive 2011/65/EU of The European Parliament and of the Council of June 8, 2011 on the restriction of the use of certain hazardous substances in electrical and electronic equipment (EEE) - recast, unless otherwise specified as non-compliant.

Please note that some Vishay documentation may still make reference to RoHS Directive 2002/95/EC. We confirm that all the products identified as being compliant to Directive 2002/95/EC conform to Directive 2011/65/EU.

Vishay Intertechnology, Inc. hereby certifies that all its products that are identified as Halogen-Free follow Halogen-Free requirements as per JEDEC JS709A standards. Please note that some Vishay documentation may still make reference to the IEC 61249-2-21 definition. We confirm that all the products identified as being compliant to IEC 61249-2-21 conform to JEDEC JS709A standards.