

Thyristor Surge Suppressor

Version: A0 2014-01-15

Features

- Excellent capability of absorbing transient surge
- Quick response to surge voltage (nS Level)
- Eliminates overvoltage caused by fast rising transients
- Moisture sensitivity level: level 1
- Weight:87mg
- Non degenerative
- Bi-directional

Exterior

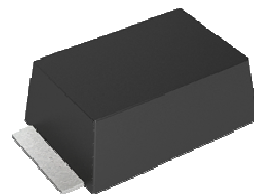

SMB-F

Application Information

- RS485/232/422

Package (Top View)



Agency Approvals

Icon	Description
RoHS	Compliance with 2011/65/EU
HF	Compliance with IEC61249-2-21:2003

Schematic Symbol



Part Number and Electrical Parameter

Part Number	IDRM@VDRM		Vs ^① @ Is		VT@ IT		IH	Co ^②
	μA	V	V	mA	V	A	mA	pF
	MAX		MAX		MAX		MIN	MAX
BS0300N-C-F	5	25	40	800	4	2.2	50	100

Absolute maximum ratings measured at TA= 25°C RH = 45%-75% (unless otherwise noted).

① Vs is measured at 100KV/S.

② Off-state Capacitance is measured at VDC=2V,VRMS=1V,f=1MHz.

Thyristor Surge Suppressor

Version: A0 2014-01-15

Part Numbering System

BS 0300 N -C -F
(1) (2) (3) (4) (5)

- (1)Bencent Semiconductor Surge Arrester
- (2)Off-state Voltage,e.g. : 0300=30×10⁰=30V
- (3) Package: SMB-F
- (4) Rating Surge Voltage: 6KV (10/700μs)
- (5)Flat Feet

V-I Curve

Parameters	Definition
V _{DRM}	Peak Off-state Voltage
I _{DRM}	Off-state Current
V _S	Switching Voltage
I _S	Switching Current
I _H	Holding Current
V _T	On-state Voltage
I _T	On-state Current
C _o	Off-state Capacitance

Mark

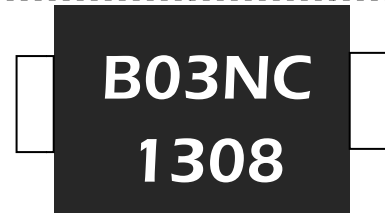

B03NC: Part Number
1308:August,2013

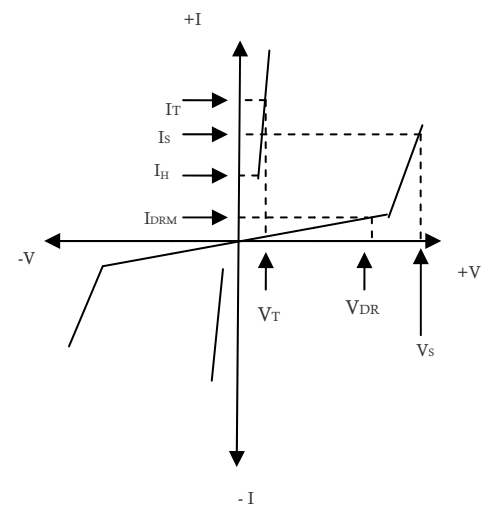

Surge Ratings

Current Waveform	2/10μs	8/20μs	10/160μs	5/320μs	10/1000μs
Voltage Waveform	2/10μs	1.2/50μs	10/160μs	10/700μs	10/1000μs
I _{pp}	500	400	200	150	100

- Peak pulse current rating (I_{pp}) is repetitive and guaranteed for the life of the product;
- Bencent only makes the test for 5/320μs @ 150A (10/700μs@6KV), but for other IPP value derived from experience is just for reference only. Bencent will not take any obligation for these parameters, so before applying our parts, please make sure to verify the parameters listed in the above table.

Thermal Considerations

symbol	Parameter	Value	Unit
T _J	Operating Junction Temperature Range	-40 to +150	°C
T _S	Storage Temperature Range	-60 to +150	°C

Physical Characteristics

Lead Material	Copper Alloy
Body Material	UL recognized epoxy meeting flammability classification 94V-0
Terminal Finish	100% Matte-Tin Plated

Typical Characteristics

Normalized holding current VS Junction Temperature

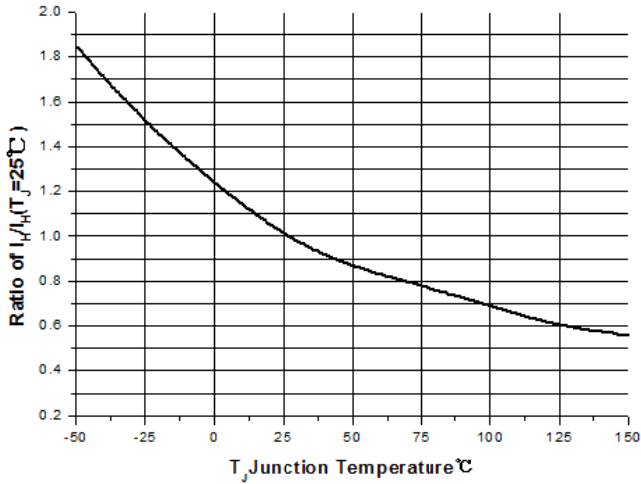

Off-state current VS Junction Temperature

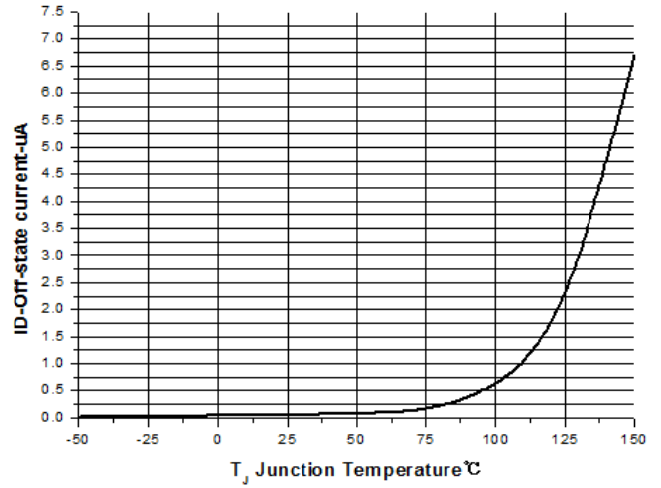

Switching Voltage VS Junction Temperature

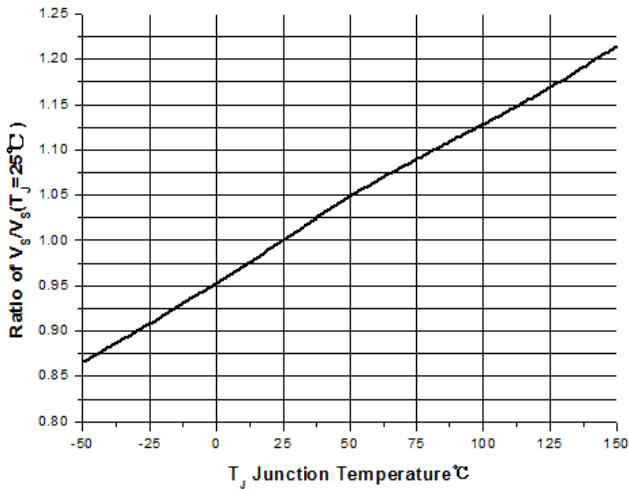

Capacitance Normalized VS Off-state Voltage

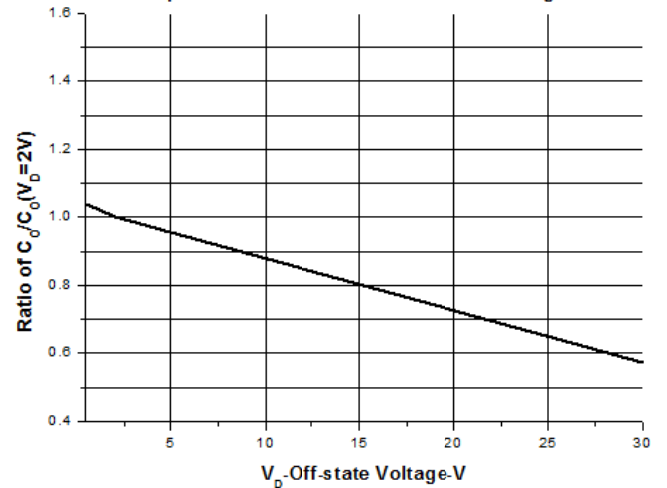

On-state voltage VS On-state current

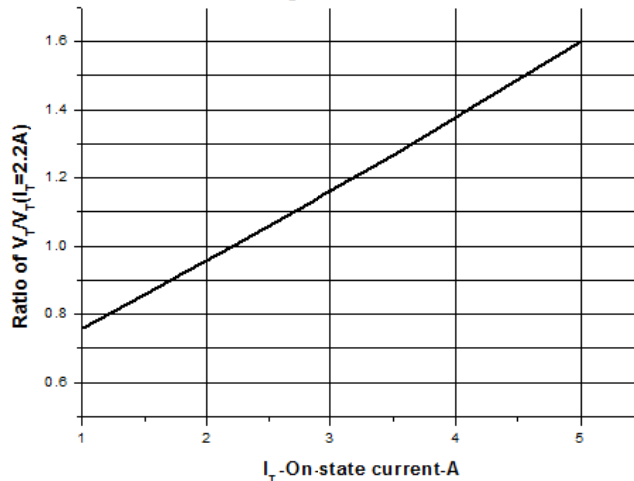

Thyristor Surge Suppressor

Version: A0 2014-01-15

Environmental Characteristics

Testing Items	Technical Standards
High Temperature Reverse Bias Test	Temperature: 150±3℃, Bias=80%V _{DRM} Time:168H
High Temperature Life Test	Temperature: 150℃ Time:168H
High-low Temperature CycleTest	Temperature:From -40℃ to125℃ Dwell time: 30min, 10-100 cycles
High Temperature &High Humidity Test	Temperature: 85℃, Humidity:85% Test time:168H
Pressure Cooker Test	Temperature: 121℃, 2atm. Humidity:100% Test time:24Hto 168H
Resistance of Soldering Heat	Temperature: 260±5℃ Time of dip soldering: 10s, 3times

Note: The above testing items can be specified by customers by contacting Bencent service

Product Dimensions

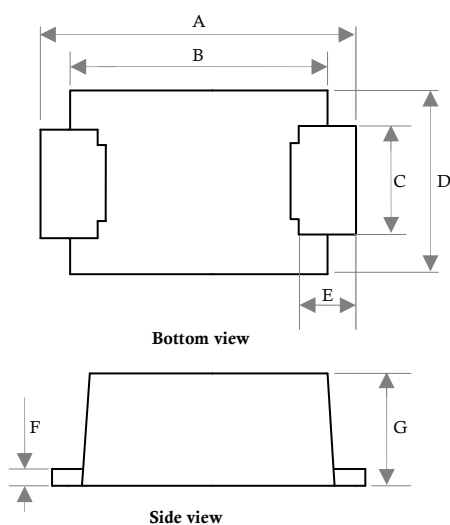

REF	mm	inch
A	5.4±0.3	0.213±0.012
B	4.4±0.2	0.173±0.008
C	2.0±0.1	0.079±0.004
D	3.3±0.3	0.130±0.012
E	0.8±0.3	0.032±0.012
F	0.25±0.05	0.010±0.002
G	2±0.3	0.079±0.012

Recommended Soldering Pad

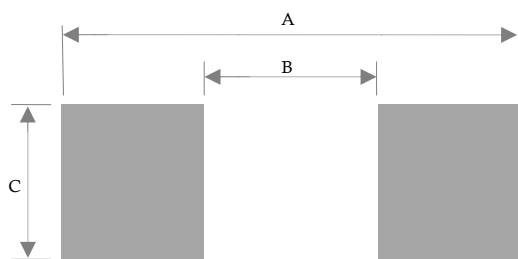

REF	mm	inch
A	6.4	0.252
B	3.4	0.134
C	2.75	0.108

Thyristor Surge Suppressor

Version: A0 2014-01-15

Reflow Profile

Reflow Condition		Pb-Free Assembly
Pre Heat	Temperature Min.	+150°C
	Temperature Max.	+200°C
	Time(Min to Max)	60 – 180 secs.
Average ramp up rate(Liquidus Temp(T_L) to peak)		3°C/sec.Max.
Ts(max) to T_L - Ramp-up Rate		3°C/sec.Max.
Reflow	- Temperature (T_L) (Liquidus)	+217°C
	- Temperature (T_L)	60 – 150 secs.
Peak Temp (T_P)		+(260+0/-5)°C
Time within 5°C of actual Peak Temp (T_P)		8 – 15secs.
Ramp-down Rate		6°C/sec.Max.
Time 25°C to peak Temp (T_P)		8 min. Max.
Do not exceed		+260°C

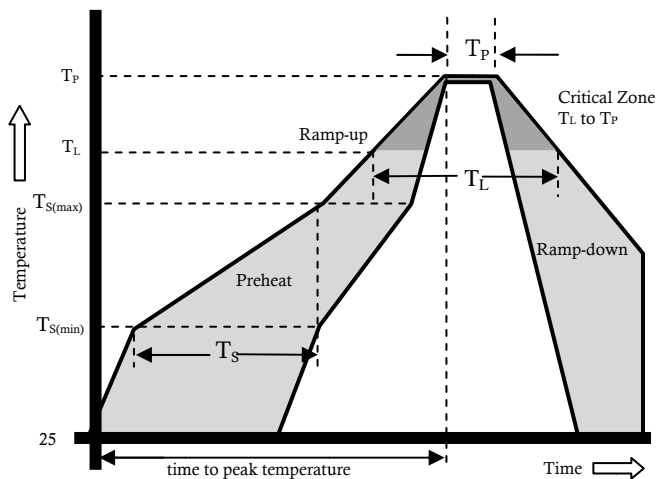

Package Reel Information

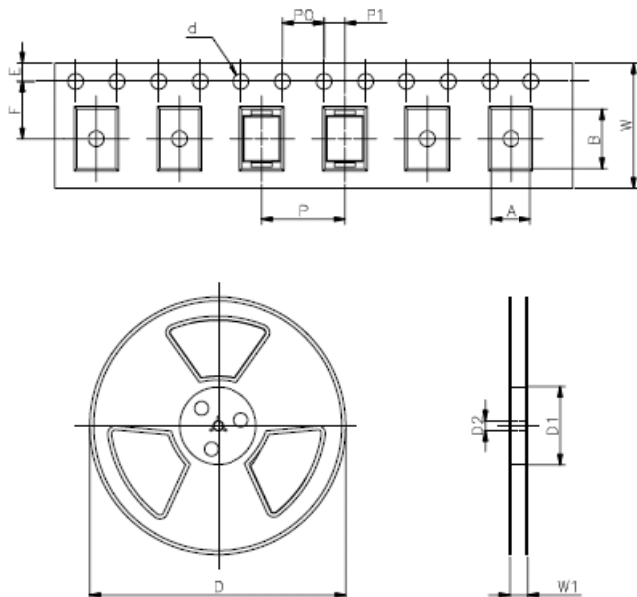

REF	mm	inch
A	3.65+/-0.3	0.144+/-0.012
B	5.69+/-0.3	0.244+/-0.012
d	1.5+/-0.1	0.059+/-0.004
D	330.0	13.0
D1	100+/-3	3.937+/-0.118
D2	13+/-0.3	0.512+/-0.012
E	1.5+/-0.2	0.059+/-0.008
F	5.65+/-0.2	0.222+/-0.008
P	8.0+/-0.2	0.315+/-0.008
P0	4.0+/-0.2	0.157+/-0.008
P1	2.0+/-0.2	0.079+/-0.008
W	12.0+/-0.2	0.472+/-0.008
W1	16.8+/-2.0	0.661+/-0.079

Outline	Reel (pcs)	Per Carton (pcs)	Reel Diameters (mm)	Carton Size(mm)		
				L	W	H
Taping	3,000	24,000	330	360	360	380