



PRODUCT SPECIFICATION

REV A January 2011

Oscilent Controlled Document

Ordering Code / Part Number	Product Description
820-IF75.0M-26A	75MHz IF SAW Filter 26.6MHz Bandwidth

Specification Contents

- o Mechanical Dimensions
- o Test Circuit
- o Maximum Ratings
- o Electrical Specification
- o Frequency Response
- o Smith Chart
- o VSWR

Notes

- o Electrostatic Sensitive Device (ESD) 
- o Avoid excessive ultrasonic exposure
- o Solderability compatible with JEDEC J-STD-020C Pb-free process, 260°C peak reflow temperature
- o This product complies with EU directive 2002/95/EC (RoHS compliance)





Mechanical Dimensions (mm)

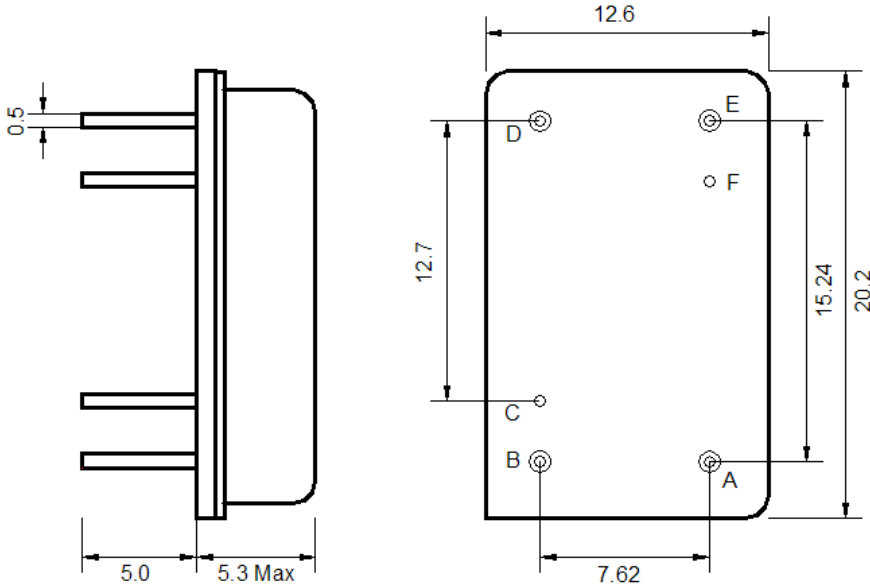

Pin Description	
B, C, D, F	Ground
A	Input
E	Output

Test Circuit

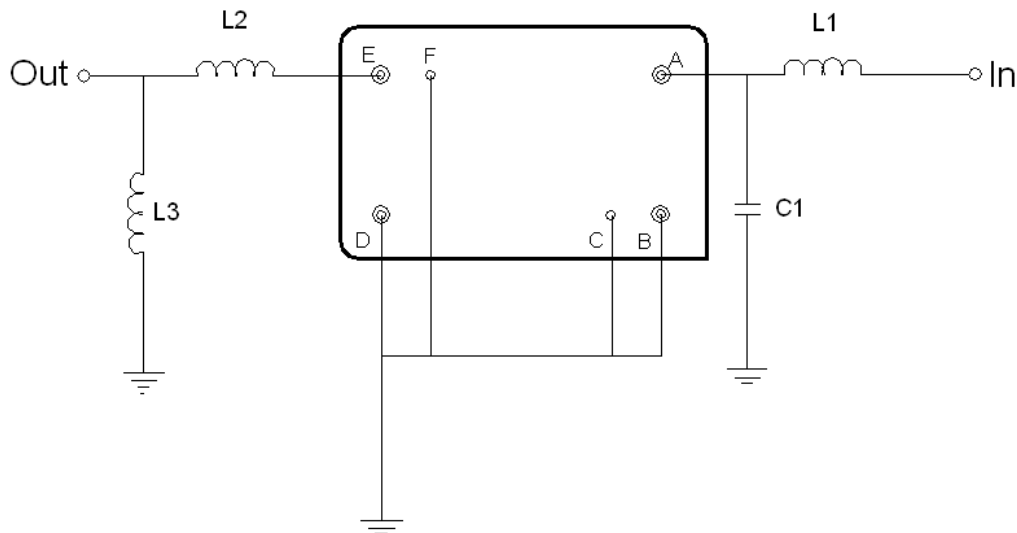

Test Fixture & Values	
Input	L1=180 nH, C1=6.8pF
Output	L2=82 nH, L3=220 nH
Source/Load Impedance	50 Ω

**Maximum Ratings**

Parameters Description	Unit	Minimum	Typical	Maximum
Operating Temperature Range	°C	-30	-	+80
Storage Temperature Range	°C	-40	-	+85
Maximum DC Voltage	V	-	-	10
Maximum Input Power	dBm	-	-	10
Source Impedance (single ended) ⁽¹⁾	Ω	-	50	-
Load Impedance (single ended) ⁽¹⁾	Ω	-	50	-

Notes: With Matching Network (Ref. Testing Environment Circuit as shown above).

Those impedances could be modified with different impedance values and/or structures, if necessary.

Electrical Specification

Parameters Description	Unit	Minimum	Typical	Maximum
Center Frequency (Fo)	MHz	-	75.0	-
Insertion Loss at Fo	dB	-	26.5	28
Group Delay Variation (Fo±12.5MHz)	ns	-	25	60
Absolute Delay	us	-	1.83	-
Temperature Coefficient	ppm/°C	-	-72	-
Passband Ripple (Fo±12.5MHz)	dB	-	0.55	1.00
Bandwidth at -1dB	MHz	-	26.6	-
Bandwidth at -20dB	MHz	-	28.4	-
Bandwidth at -50dB	MHz	-	29.2	-
Ultimate Rejection	dB	-	53	-
Relative Attenuation Fo±16MHz	dB	-	53	-



Frequency Response

Bandwidth at -1.0 dB

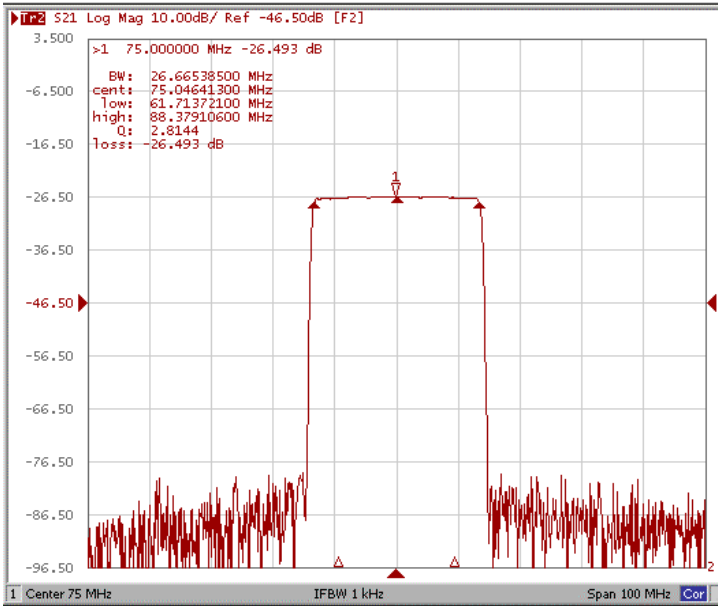

Bandwidth at -20.0 dB

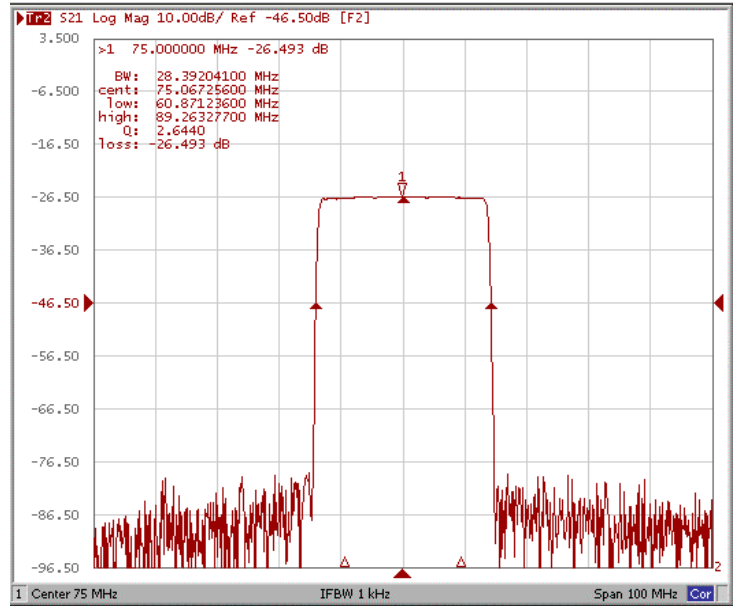

Bandwidth at -50.0 dB

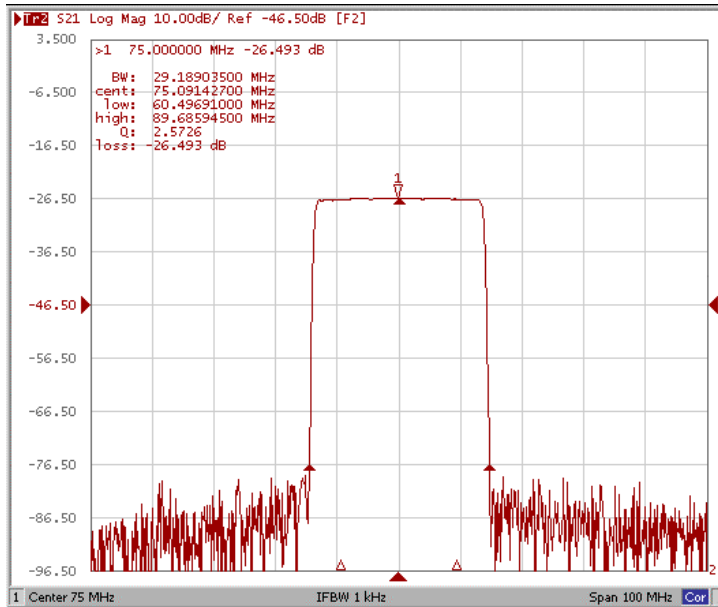

Relative Attenuation Fo±16MHz

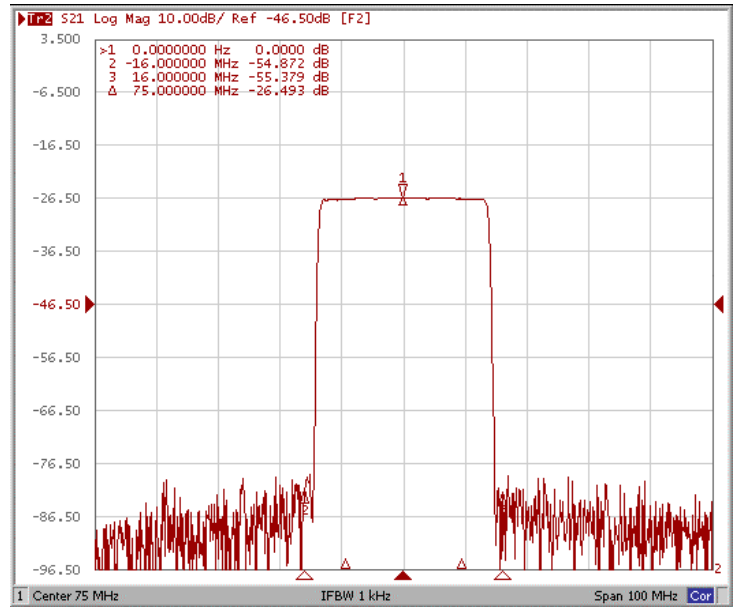



Ripple Variation $F_o \pm 12.5\text{MHz}$

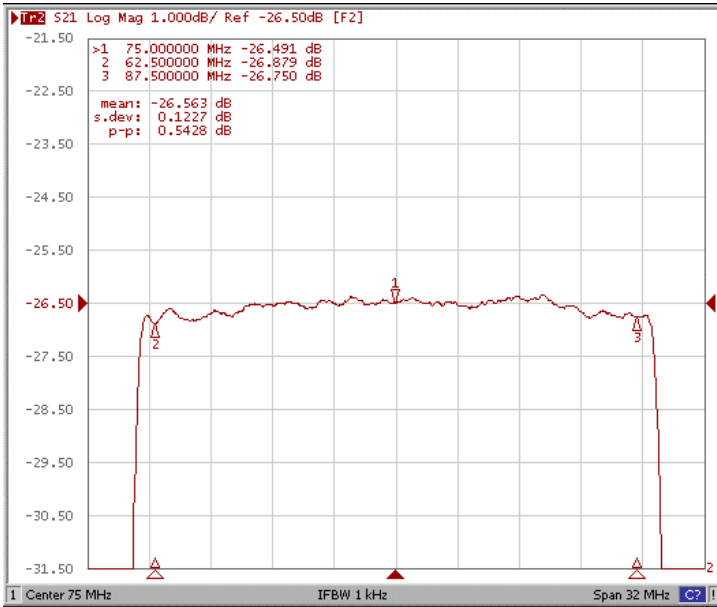

Group Delay Variation $F_o \pm 12.5\text{MHz}$

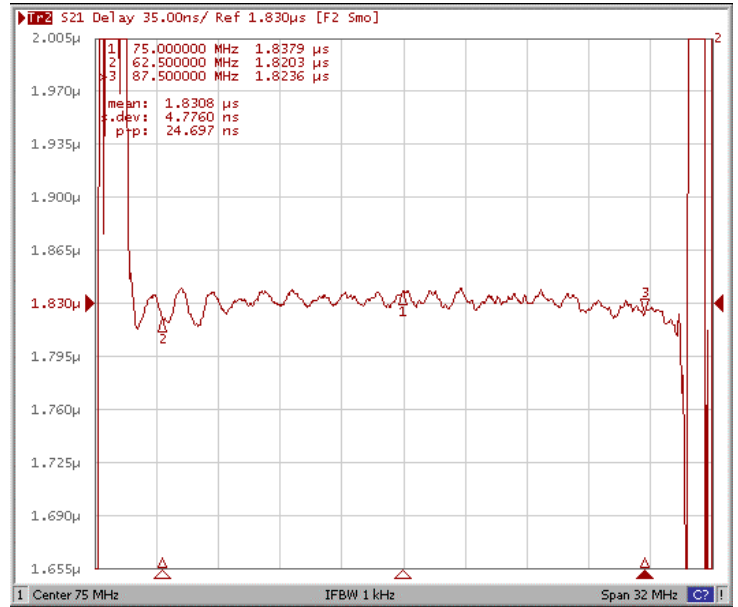

Smith Chart

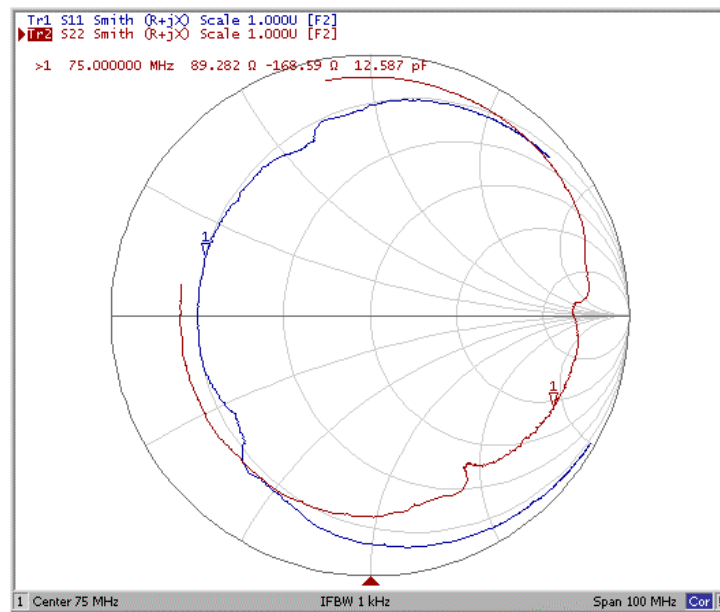



VSWR

