

PNP Transistors

2SB934

■ Features

- Low collector to emitter saturation voltage $V_{CE(sat)}$
- Satisfactory linearity of forward current transfer ratio h_{FE}
- Large collector current I_c
- Complementary to 2SD1257

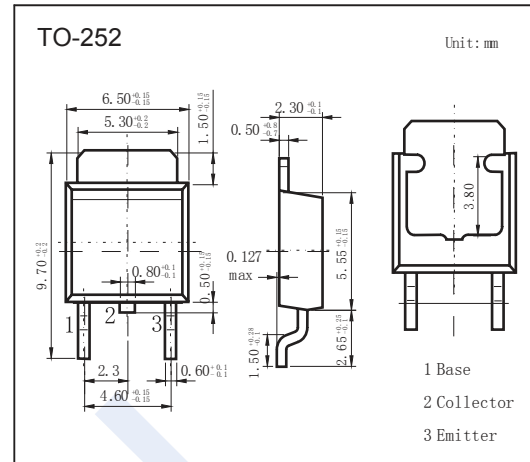

■ Absolute Maximum Ratings $T_a = 25^\circ\text{C}$

Parameter	Symbol	Rating	Unit
Collector - Base Voltage	V_{CB0}	-130	V
Collector - Emitter Voltage	V_{CE0}	-80	
Emitter - Base Voltage	V_{EB0}	-7	
Collector Current - Continuous	I_c	-7	A
Collector current - Pulse	I_{CP}	-15	
Collector Power Dissipation	P_c	$T_c = 25^\circ\text{C}$ 40	W
		$T_a = 25^\circ\text{C}$ 1.3	
Junction Temperature	T_J	150	$^\circ\text{C}$
Storage Temperature range	T_{stg}	-55 to 150	

■ Electrical Characteristics $T_a = 25^\circ\text{C}$

Parameter	Symbol	Test Conditions	Min	Typ	Max	Unit
Collector- base breakdown voltage	V_{CB0}	$I_c = -100 \mu\text{A}$, $I_E = 0$	-130			V
Collector- emitter breakdown voltage	V_{CE0}	$I_c = -10 \text{ mA}$, $I_B = 0$	-80			
Emitter - base breakdown voltage	V_{EB0}	$I_E = -100 \mu\text{A}$, $I_c = 0$	-7			
Collector-base cut-off current	I_{CB0}	$V_{CB} = -100\text{V}$, $I_E = 0$			-10	μA
Emitter cut-off current	I_{EB0}	$V_{EB} = -5\text{V}$, $I_c = 0$			-50	
Collector-emitter saturation voltage	$V_{CE(sat)}$	$I_c = -5 \text{ A}$, $I_B = -250\text{mA}$			-0.5	V
Base - emitter saturation voltage	$V_{BE(sat)}$	$I_c = -5 \text{ A}$, $I_B = -250\text{mA}$			-1.5	
DC current gain	$h_{FE(1)}$	$V_{CE} = -2\text{V}$, $I_c = -100\text{mA}$	45			
	$h_{FE(2)}$	$V_{CE} = -2\text{V}$, $I_c = -3 \text{ A}$	90		260	
Turn-on time	t_{on}	$I_c = -3 \text{ A}$, $I_{B1} = -300\text{mA}$, $I_{B2} = 300\text{mA}$		0.5		μs
Storage time	t_{stg}			1.5		
Fall time	t_f			0.1		
Transition frequency	f_T	$V_{CE} = -10\text{V}$, $I_c = -500\text{mA}$, $f = 10\text{MHz}$		30		MHz

■ Classification of $h_{FE(2)}$

Type	2SB934-Q	2SB934-P
Range	90-180	130-260

PNP Transistors

2SB934

Typical Characteristics

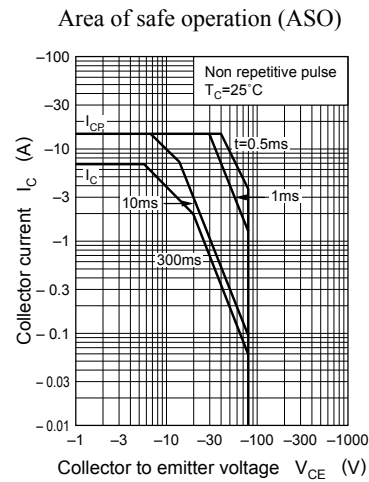
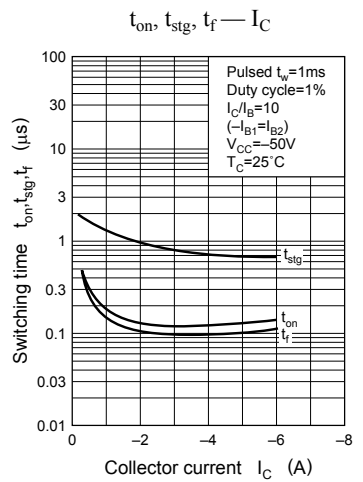
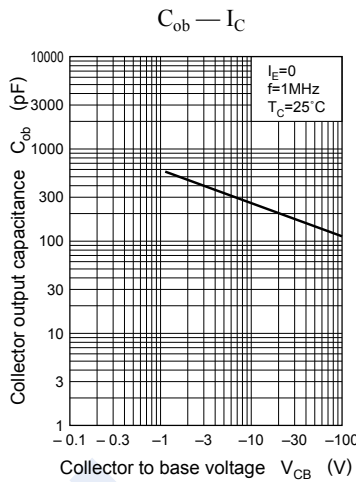
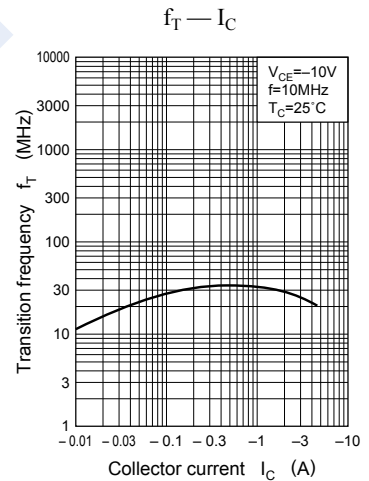
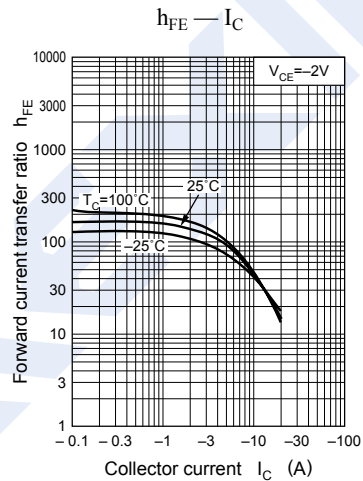
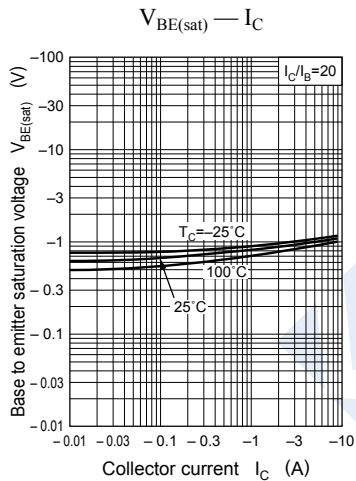
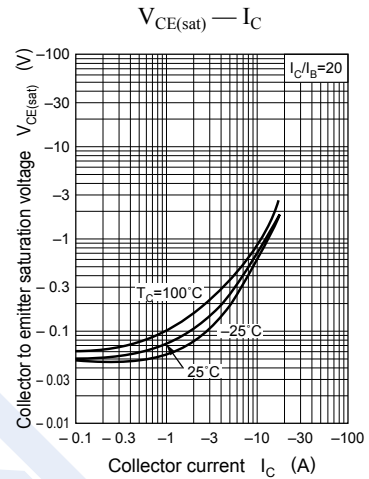
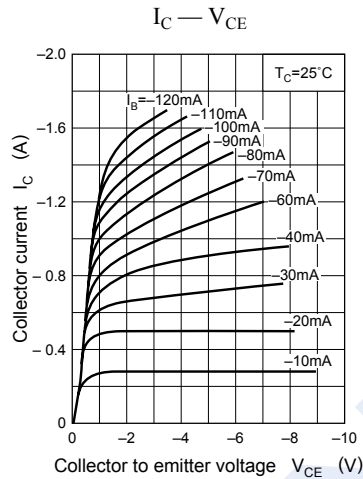
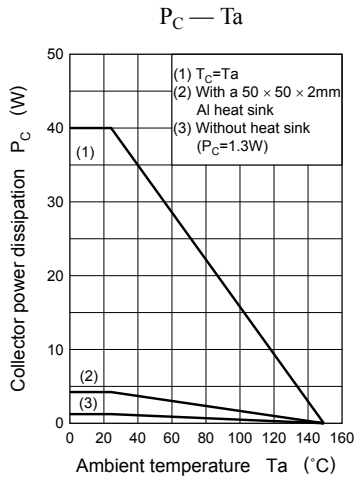

PNP Transistors

2SB934

■ Typical Characteristics

