

ESD9FN3.3

List

List..... 1

Package outline..... 2

Features.....2

Mechanical data.....2

Maximum ratings 2

Electrical characteristics.....2

Typical characteristics.....3

Rating and characteristic curves.....4

Pinning information..... 5

Marking.....5

Suggested solder pad layout..... 5

Packing information..... 6

Reel packing.....7

Suggested thermal profiles for soldering processes.....7

ESD9FN3.3

72W Surface Mount TVS Uni-directional
For ESD Protection- 3.3V

Features

- Small body outline dimensions:
0.039" X 0.024" (1.0mm X 0.60mm).
- Halogen free.
- Provide transient protection:
IEC 61000-4-2 (ESD) Level 4
IEC 61000-4-4 (EFT) 80A (5/50ns)
IEC 61000-4-5 (Surge) (8/20us)
- Low leakage current.
- Suffix "-H" indicates Halogen-free parts, ex. ESD9FN3.3-H.

Mechanical data

- Epoxy: UL94-V0 rated flame retardant
- Case: Molded plastic,0402
- Terminals: Golden Plated terminals,
solderable per MIL-STD-750,Method 2026
- Marking Code: Z
- Weight: Approximated 0.001gram

Schematic & Pin Configuration

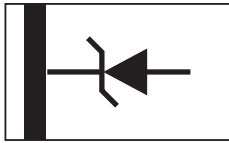

Package outline

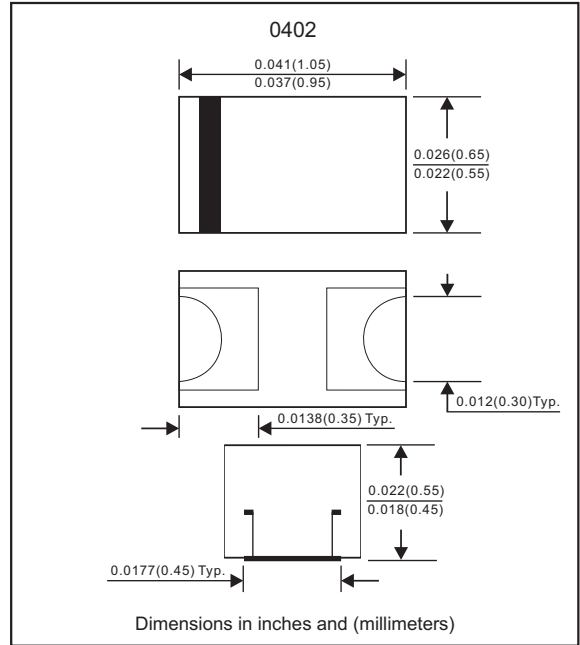

Maximum ratings (at T_A=25°C unless otherwise noted)

PARAMETER	CONDITIONS	Symbol	MIN.	TYP.	MAX.	UNIT
Peak pulse power	tp = 8/20us	P _{PP}			72	W
Peak pulse current	tp = 8/20us (IEC 61000-4-5)	I _{PP}			6	A
ESD per IEC 61000-4-2	Air discharge	ESD			±20	kV
	Contact discharge				±15	
Operating junction temperature range		T _J	-55		+125	°C
Storage temperature range		T _{STG}	-55		+150	°C

Stresses exceeding Maximum Ratings may damage the device. Maximum Ratings are stress ratings only. Functional operation above the Recommended Operating Conditions is not implied. Extended exposure to stresses above the Recommended Operating Conditions may affect device reliability.

Electrical characteristics (at T_A=25°C unless otherwise noted, V_F = 1.2V Max. @I_F = 10mA)

Part No.	V _{RWM} (V)	I _R (uA) @V _{RWM}	I _T (mA)	V _{BR} (V) @I _T	V _C (V) @I _{PP} =6A	C _J (pF) @V _R =0V,f=1MHz
	Max.	Max.		Min.	Max.	Typ.
ESD9FN3.3	3.3	3.0	1.0	5.0	12	45

Over voltage available upon request.

1. V_{BR} is measured with a pulse test current I_T at an ambient temperature of 25°C.
2. Surge current waveform per Figure 1.

ESD9FN3.3

Typical characteristics (at $T_a=25^\circ\text{C}$ unless otherwise noted)

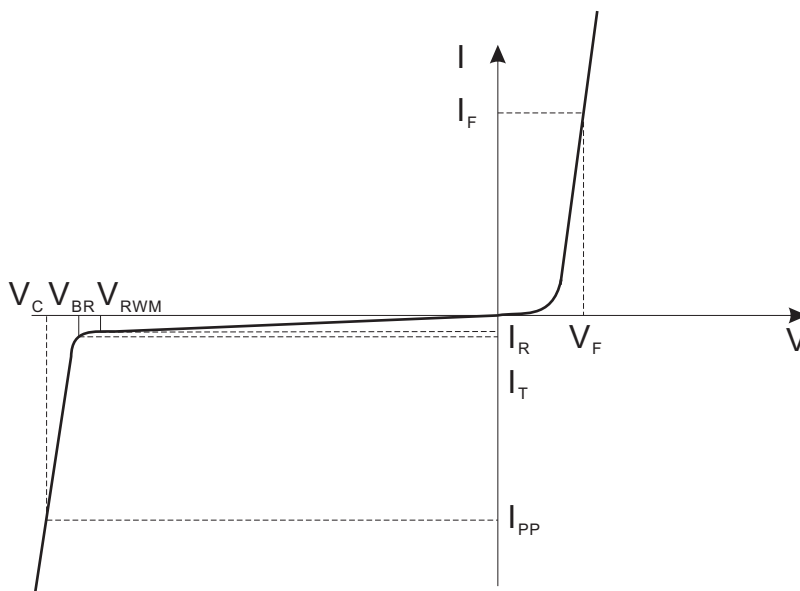

Uni-Directional TVS

V_C : Clamping Voltage @ I_{PP}

I_{PP} : Maximum Reverse Peak Pulse Current

V_{RWM} : Maximum Reverse Working voltage

I_R : Maximum Reverse Leakage Current @ V_{RWM}

V_{BR} : Breakdown voltage @ I_T

I_T : Test Current

P_{PP} : Peak Pulse Power

I_F : Forward Current

V_F : Forward Voltage @ I_F

C_J : Typ. Capacitance @ $V_R = 0\text{V}$ and $f = 1\text{MHz}$

Rating and characteristic curves (ESD9FN3.3)

FIG.1- 8 X 20us PULSE WAVEFORM

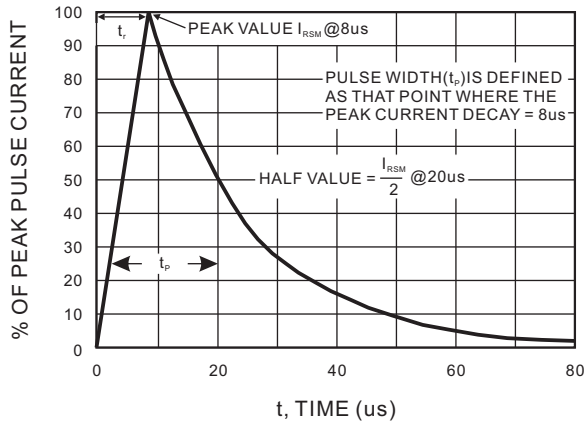

FIG.2- POWER RATING DERATING CURVE

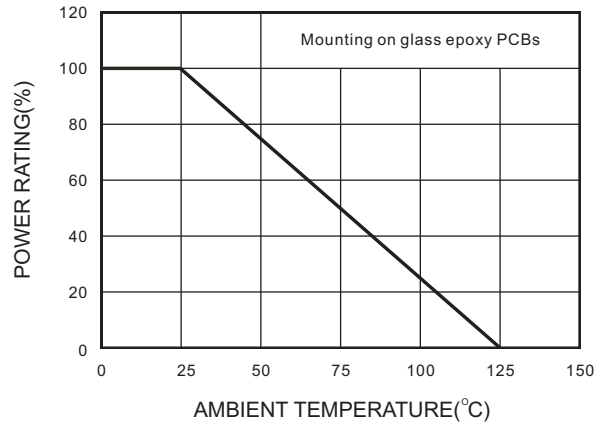
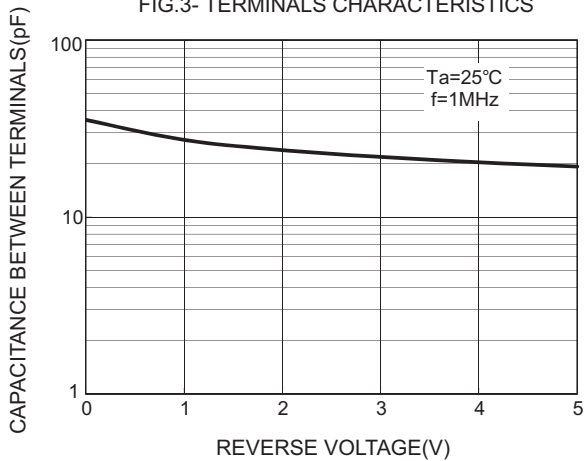

FIG.3- TERMINALS CHARACTERISTICS



ESD9FN3.3

Pinning information

Pin	Simplified outline	Symbol
Pin1 cathode Pin2 anode		

Marking

Type number	Marking code	Example
ESD9FN3.3	Z	

Suggested solder pad layout

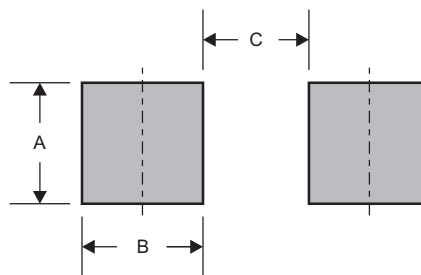

Dimensions in inches and (millimeters)

PACKAGE	A	B	C
0402	0.028 (0.70)	0.020 (0.50)	0.010 (0.25)

ESD9FN3.3

Packing information

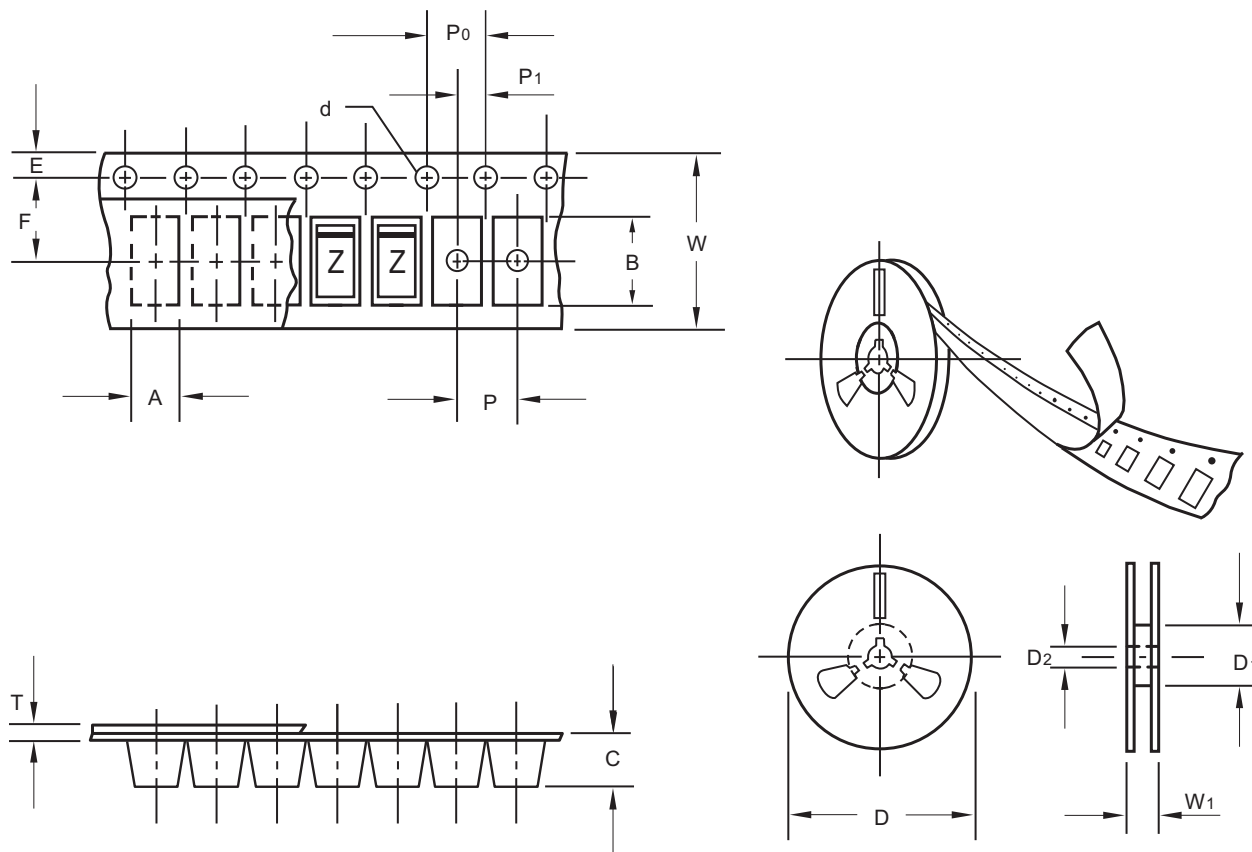

unit:mm

Item	Symbol	Tolerance	0402
Carrier width	A	0.05	0.74
Carrier length	B	0.05	1.17
Carrier depth	C	0.05	0.62
Sprocket hole	d	0.1	1.50
13" Reel outside diameter	D	2.0	-
13" Reel inner diameter	D1	min	-
7" Reel outside diameter	D	2.0	178.00
7" Reel inner diameter	D1	min	62.00
Feed hole diameter	D2	0.5	13.00
Sprocket hole position	E	0.1	1.75
Punch hole position	F	0.1	3.50
Punch hole pitch	P	0.1	2.00
Sprocket hole pitch	P0	0.1	4.00
Embossment center	P1	0.1	2.00
Overall tape thickness	T	0.1	0.23
Tape width	W	0.3	8.00
Reel width	W1	1.0	11.40

Note: Devices are packed in accordance with EIA standard RS-481-A and specifications listed above.

ESD9FN3.3

Reel packing

PACKAGE	REEL SIZE	REEL (pcs)	COMPONENT SPACING (m/m)	BOX (pcs)	INNER BOX (m/m)	REEL DIA, (m/m)	CARTON SIZE (m/m)	CARTON (pcs)	APPROX. GROSS WEIGHT (kg)
0402	7"	10,000	2.0	100,000	183*123*183	178	382*257*387	800,000	8.5

Suggested thermal profiles for soldering processes

- 1.Storage environment: Temperature=5°C~40°C Humidity=55%±25%
- 2.Reflow soldering of surface-mount devices

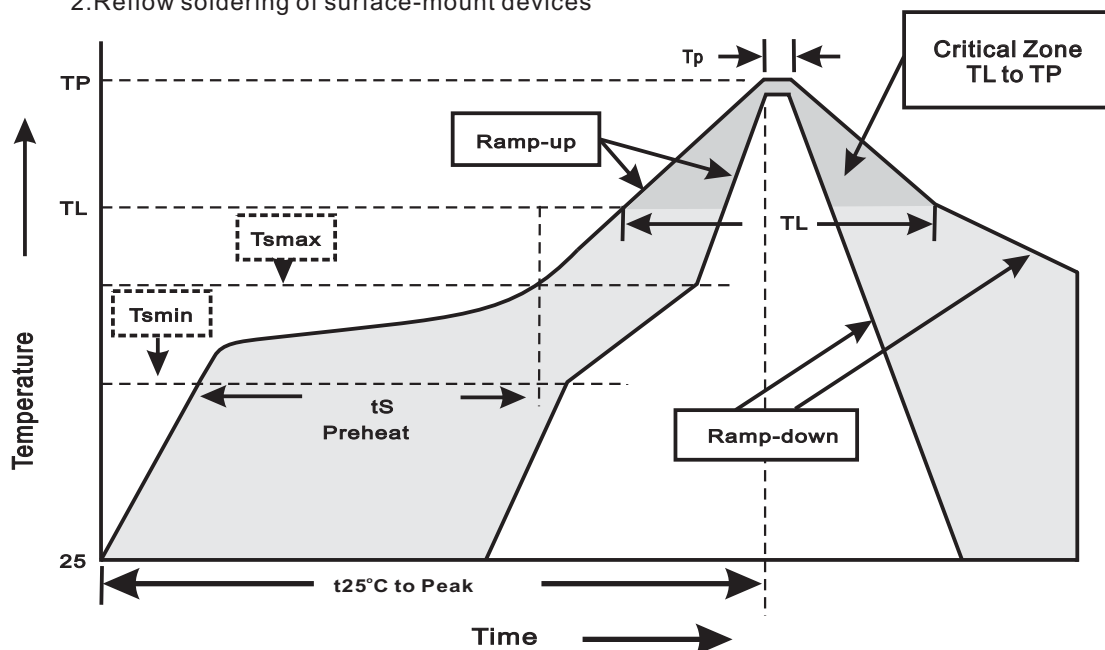

3.Reflow soldering

Profile Feature	Soldering Condition
Average ramp-up rate(TL to TP)	<3°C/sec
Preheat -Temperature Min(Tsmin) -Temperature Max(Tsmax) -Time(min to max)(ts)	150°C 200°C 60~120sec
Tsmax to TL -Ramp-upRate	<3°C/sec
Time maintained above: -Temperature(TL) -Time(tL)	217°C 60~260sec
Peak Temperature(TP)	255°C-0/+5°C
Time within 5°C of actual Peak Temperature(tp)	10~30sec
Ramp-down Rate	<6°C/sec
Time 25°C to Peak Temperature	<6minutes