

WIREWOUND TYPE COMMON MODE FILTER

W1210 SERIES

1. PART NO. EXPRESSION :

W 1 2 1 0 F 9 0 0 - R B - □ □
 (a) (b) (c) (d) (e) (f) (g)

- (a) Series code
- (b) Dimension code
- (c) Material code
- (d) Impedance code : 900 = 90Ω
- (e) R : Tape & Reel
- (f) Rated Current : B = 200mA
- (g) 10: Standard
- 11 ~ 99 : Internal control number

2. CONFIGURATION & DIMENSIONS :

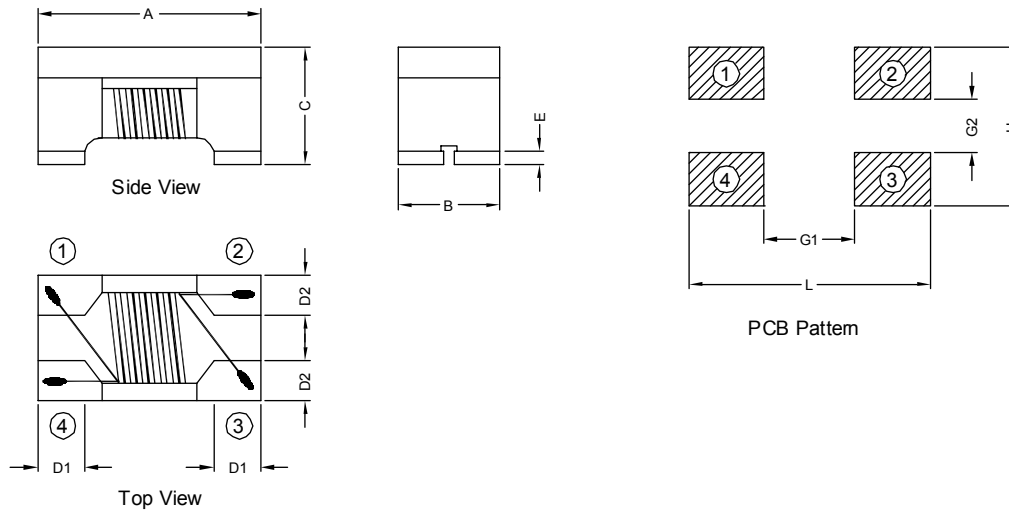

Unit:m/m

A	B	C	D1	D2	E	G1	G2	H	L
1.20 ± 0.2	1.00 ± 0.2	0.90 Max.	0.35 ± 0.1	0.35 ± 0.1	0.03 Min.	0.65 Ref.	0.30 Ref.	1.10 Ref.	1.55 Ref.

3. SCHEMATIC :

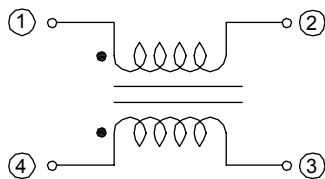

4. MATERIALS :

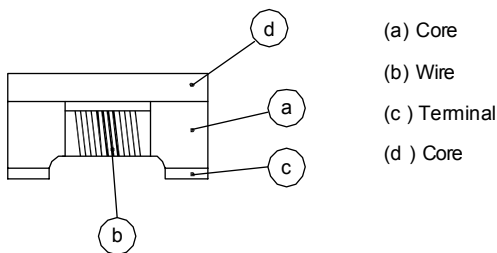

NOTE : Specifications subject to change without notice. Please check our website for latest information.



RoHS Compliant

20.05.2014

5. GENERAL SPECIFICATION :

- a) Operating temp. : -40° C to 125° C
- b) Storage condition (component in its packaging)
 - i) Temperature : -10 to 40° C
 - ii) Humidity : 60%

6. ELECTRICAL CHARACTERISTICS :

Part No.	Impedance (Ω)	Test Frequency (MHz)	DCR (Ω) Max.	Rated Current (mA)	Rated Voltage (Vdc)	Withstand Voltage (Vdc)	IR (Ω) Min.
W1210F500-RB-10	50 \pm 25%	100	0.30	250	50	125	10M
W1210F670-RB-10	67 \pm 25%	100	0.30	250	50	125	10M
W1210F900-RB-10	90 \pm 25%	100	0.40	200	50	125	10M



RoHS Compliant

NOTE : Specifications subject to change without notice. Please check our website for latest information.

20.05.2014



SUPERWORLD ELECTRONICS (S) PTE LTD

PG. 2

7. CHARACTERISTIC CURVES :

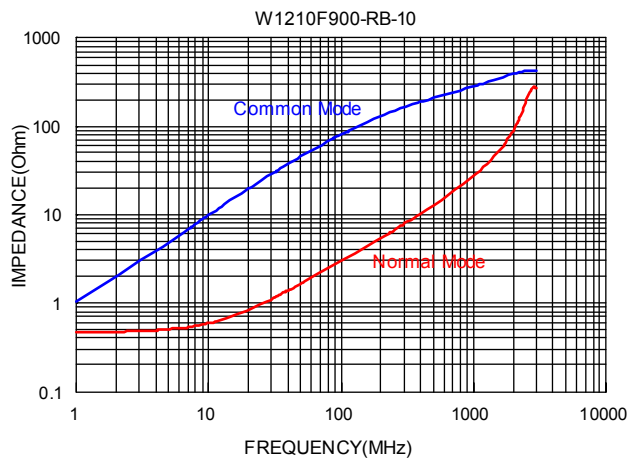
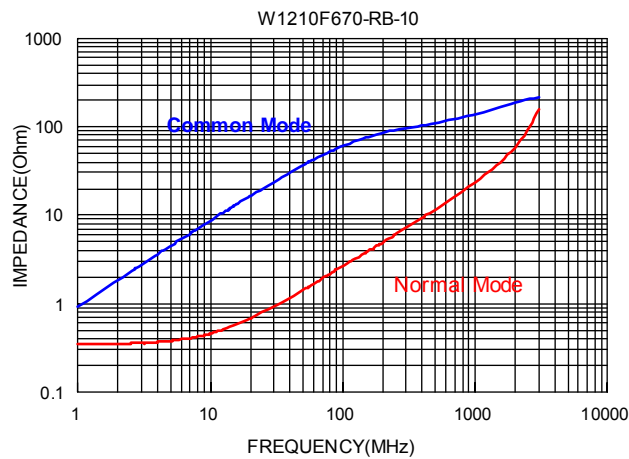
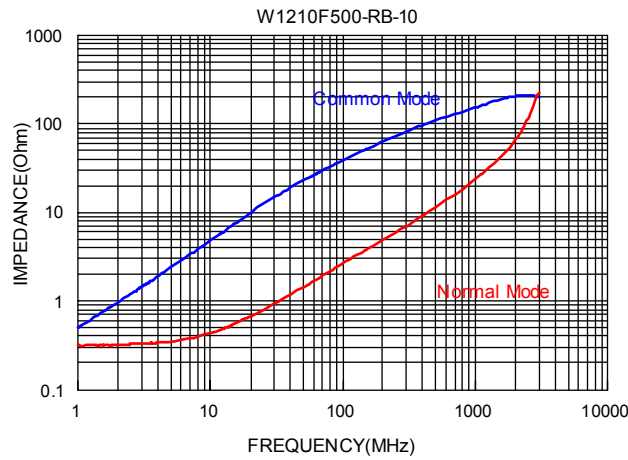

RoHS Compliant

NOTE : Specifications subject to change without notice. Please check our website for latest information.

20.05.2014



SUPERWORLD ELECTRONICS (S) PTE LTD

7-1. Insertion Loss Test

W1210F500-RB-10

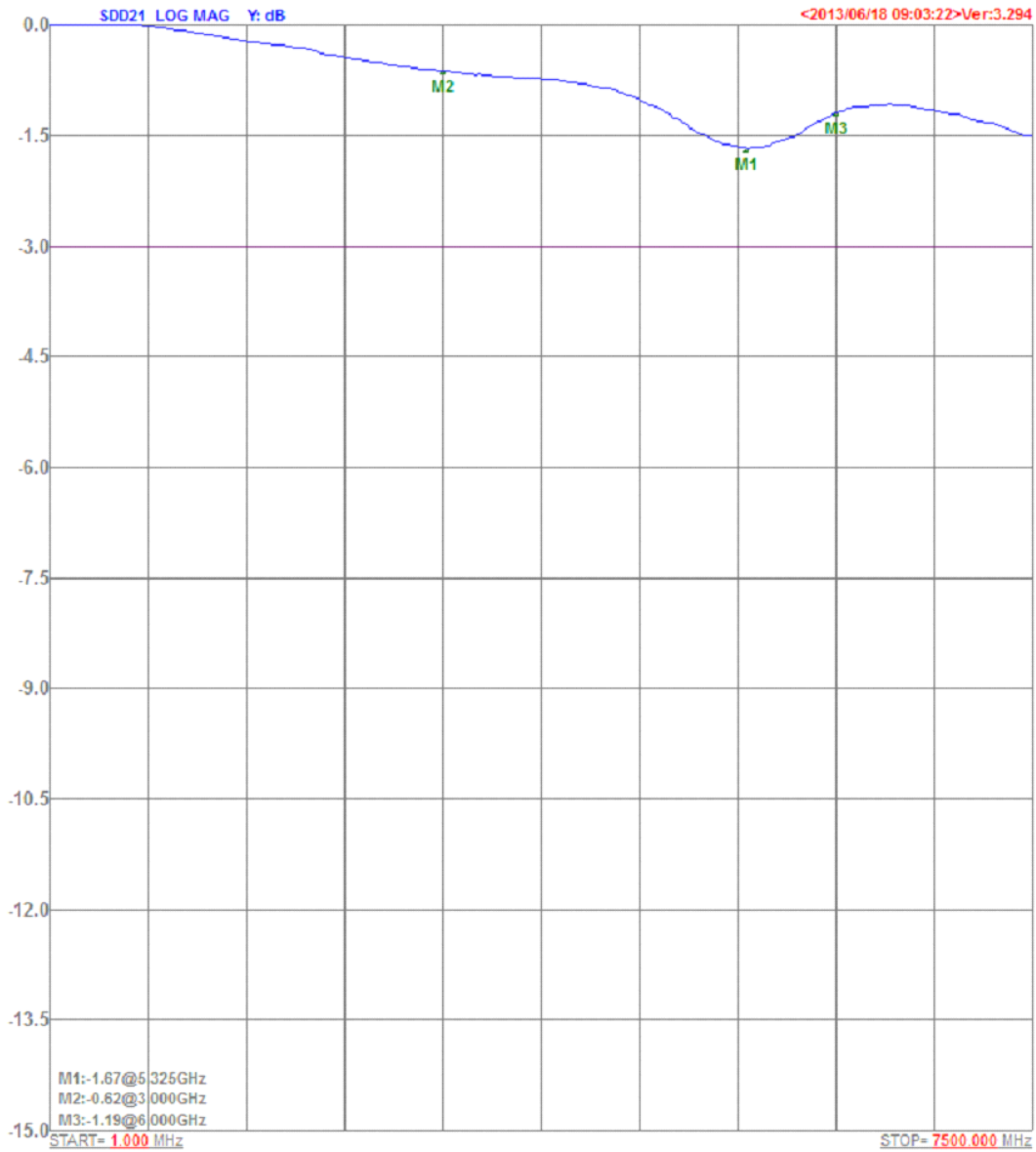

RoHS Compliant

NOTE : Specifications subject to change without notice. Please check our website for latest information.

20.05.2014



SUPERWORLD ELECTRONICS (S) PTE LTD

W1210F670-RB-10

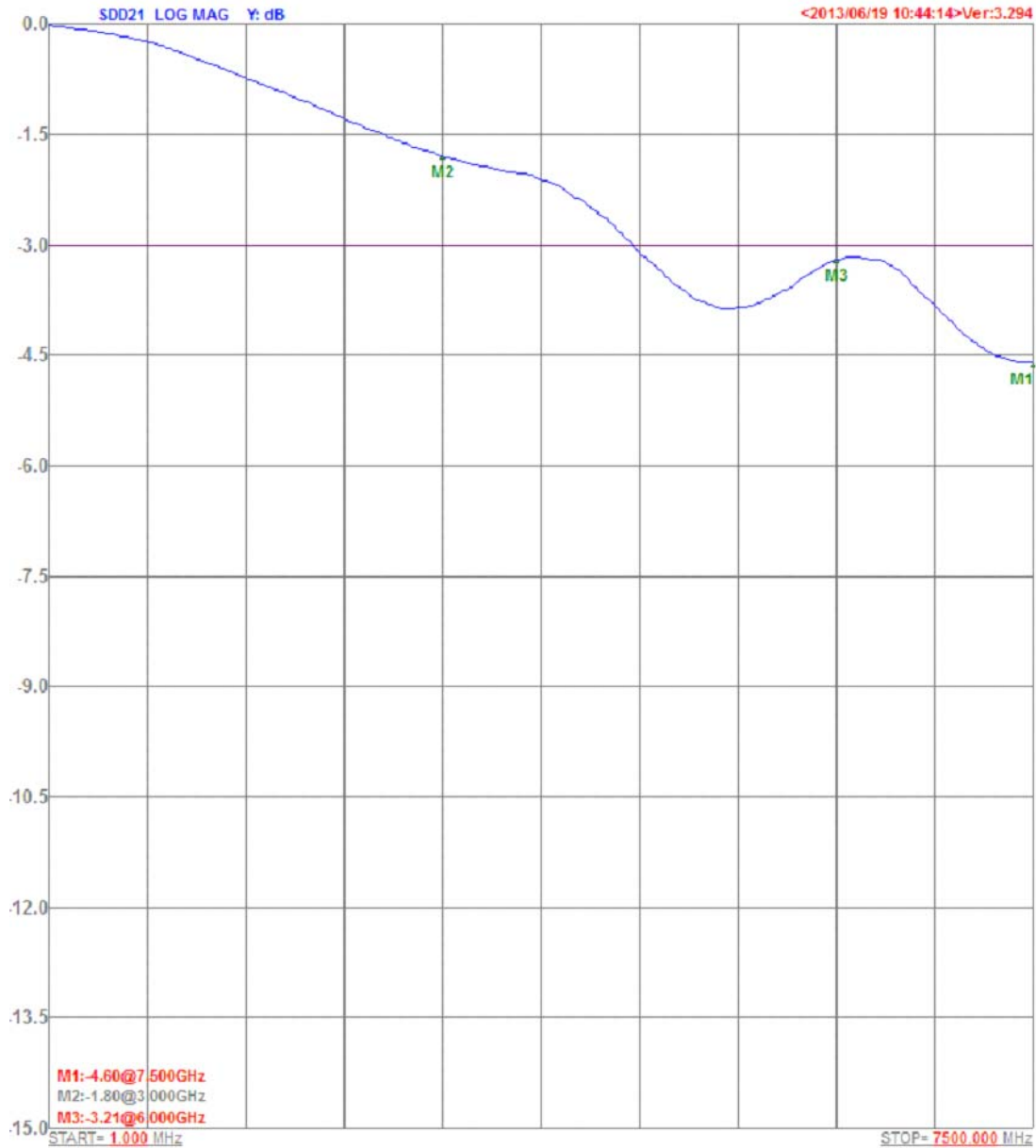

RoHS Compliant

NOTE : Specifications subject to change without notice. Please check our website for latest information.

20.05.2014



W1210F900-RB-10

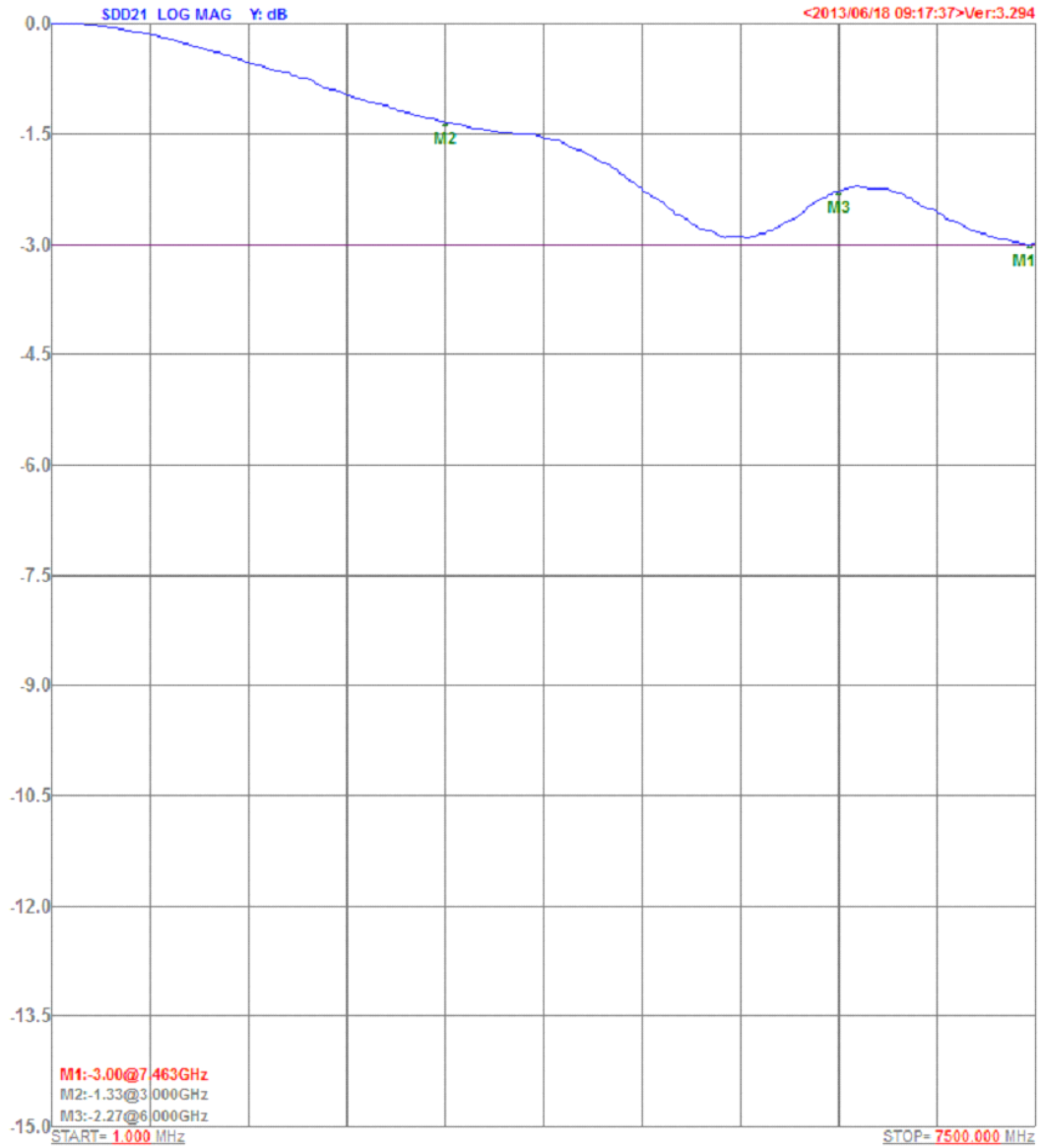

RoHS Compliant

NOTE : Specifications subject to change without notice. Please check our website for latest information.

20.05.2014



SUPERWORLD ELECTRONICS (S) PTE LTD

8. SOLDERING AND MOUNTING :

8-1. Soldering

Mildly activated rosin fluxes are preferred. Our terminations are suitable for all wave and re-flow soldering systems. If hand soldering cannot be avoided, the preferred technique is the utilization of hot air soldering tools.

8-1.1 Solder Re-flow :

Recommended temperature profiles for re-flow soldering in Figure 1.

8-1.2 Soldering Iron (Figure 2) :

Products attachment with soldering iron is discouraged due to the inherent process control limitations. In the event that a soldering iron must be employed the following precautions are recommended.

Note :

- a) Preheat circuit and products to 150° C.
- b) 355° C tip temperature (max)
- c) Never contact the ceramic with the iron tip
- d) 1.0mm tip diameter (max)
- e) Use a 20 watt soldering iron with tip diameter of 1.0mm
- f) Limit soldering time to 4-5 secs.

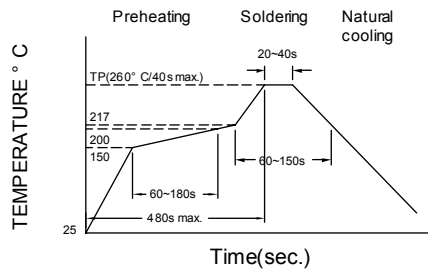

Figure 1. Re-flow Soldering : 3 times max.

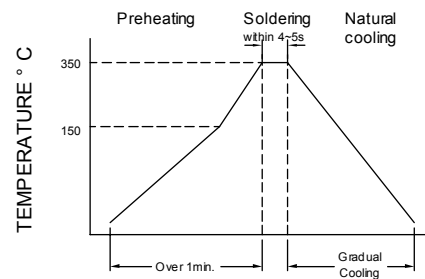

Figure 2. Iron Soldering times: 1 times max.



RoHS Compliant

NOTE : Specifications subject to change without notice. Please check our website for latest information.

20.05.2014



SUPERWORLD ELECTRONICS (S) PTE LTD

PG. 7

9. PACKAGING INFORMATION :

9-1. Reel Dimension

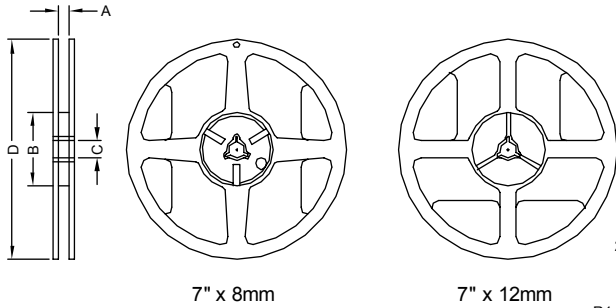

Type	A(mm)	B(mm)	C(mm)	D(mm)
7" x 8mm	9.0±0.5	60.0±2.0	13.5±0.5	178.0±2.0

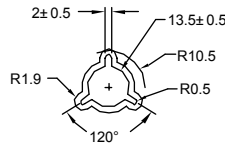

9-2 Tape Dimension / 8mm

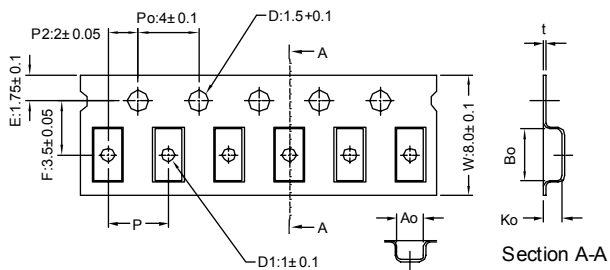

Series	Size	Ao(mm)	Bo(mm)	Ko(mm)	P(mm)	t(mm)
W1210	1210	1.25±0.10	1.50±0.10	1.05±0.10	4.0±0.1	0.22±0.05

9-3. Packing Quantity

Series	W1210
Chip / Reel	3000
Inner Box	15000
Middle Box	75000
Carton	150000



RoHS Compliant

NOTE : Specifications subject to change without notice. Please check our website for latest information.

20.05.2014



SUPERWORLD ELECTRONICS (S) PTE LTD

9-4. Tearing Off Force

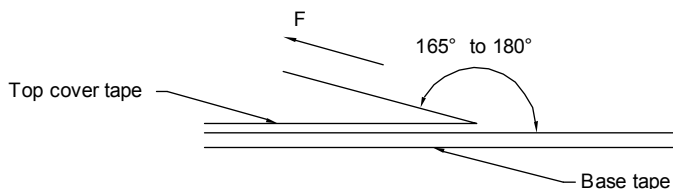

The force for tearing off cover tape is 15 to 80 grams in the arrow direction under the following conditions.

Room Temp. (° C)	Room Humidity (%)	Room atm (hPa)	Tearing Speed (mm/min)
5~35	45~85	860~1060	300

Application Notice

1. Storage Conditions :

To maintain the solderability of terminal electrodes :

- a) Recommended products should be used within 12 months from the time of delivery.
- b) The packaging material should be kept where no chlorine or sulfur exists in the air.

2. Transportation :

- a) Products should be handled with care to avoid damage or contamination from perspiration and skin oils.
- b) The use of tweezers or vacuum pick up is strongly recommended for individual components.
- c) Bulk handling should ensure that abrasion and mechanical shock are minimized.



RoHS Compliant

NOTE : Specifications subject to change without notice. Please check our website for latest information.

20.05.2014



SUPERWORLD ELECTRONICS (S) PTE LTD