

**N- AND P-Channel Enhancement Mode MOSFET**

# MTD120C10H8

	N-CH	P-CH
$BV_{DSS}$	100V	-100V
$I_D@V_{GS}=10V(-10V), T_A=25^\circ C$	2.7A	-3.0A
$I_D@V_{GS}=10V(-10V), T_C=25^\circ C$	7.8A	-8.8A
$R_{DS(on)(typ)}@V_{GS}=10V(-10V)$	128m $\Omega$	114m $\Omega$
$R_{DS(on)(typ)}@V_{GS}=4.5V(-4.5V)$	135m $\Omega$	133m $\Omega$

**Features**

- Simple drive requirement
- Low on-resistance
- Fast switching speed
- Pb-free lead plating and halogen-free package

**Equivalent Circuit**

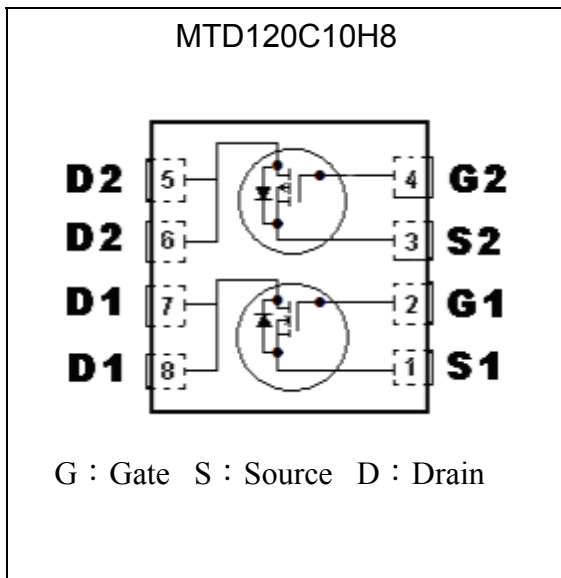

**Outline**

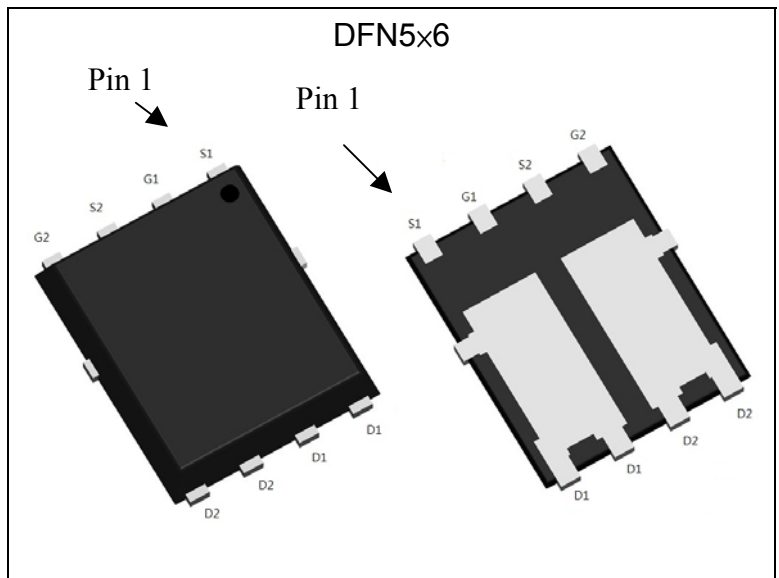

**Ordering Information**

Device	Package	Shipping
MTD120C10H8-0-T6-G	DFN 5 x6 (Pb-free lead plating & halogen-free package)	3000 pcs / Tape & Reel

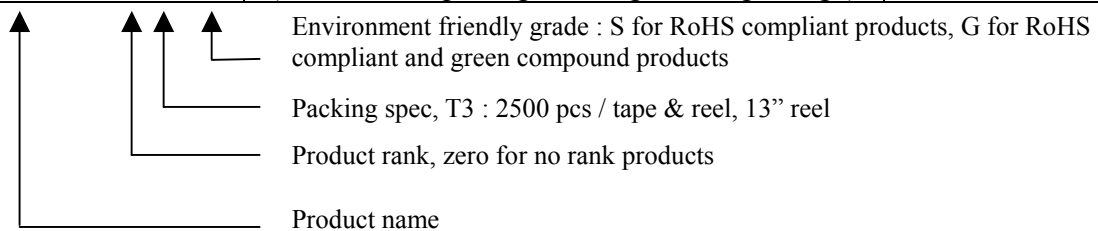



**Absolute Maximum Ratings** (T<sub>C</sub>=25°C, unless otherwise noted)

Parameter	Symbol	Limits		Unit	
		N-channel	P-channel		
Drain-Source Breakdown Voltage	BV <sub>DSS</sub>	100	-100	V	
Gate-Source Voltage	V <sub>GS</sub>	±20	±20		
Continuous Drain Current	T <sub>A</sub> =25 °C, V <sub>GS</sub> =10V (-10V)	I <sub>DSM</sub>	2.7	A	
	T <sub>A</sub> =70 °C, V <sub>GS</sub> =10V (-10V)		2.2		
	T <sub>C</sub> =25 °C, V <sub>GS</sub> =10V (-10V)	I <sub>D</sub>	7.8		
	T <sub>C</sub> =100 °C, V <sub>GS</sub> =10V (-10V)		4.9		
Pulsed Drain Current (Note 1 & 2)	I <sub>DM</sub>	25	-28		
Power Dissipation	T <sub>A</sub> =25 °C	P <sub>DSM</sub>	2.5 (Note 3)		W
	T <sub>A</sub> =70 °C		1.6 (Note 3)		
	T <sub>C</sub> =25 °C	P <sub>D</sub>	21		
	T <sub>C</sub> =100 °C		8.4		
Operating Junction and Storage Temperature Range	T <sub>j</sub> ; T <sub>stg</sub>	-55~+150		°C	

**Thermal Data**

Parameter	Symbol	Value	Unit
Thermal Resistance, Junction-to-case, max	R <sub>θJC</sub>	6	°C/W
Thermal Resistance, Junction-to-ambient, max	R <sub>θJA</sub>	50 (Note 3)	

- Note : 1. Pulse width limited by maximum junction temperature  
 2. Duty cycle ≤ 1%  
 3. Surface mounted on 1 in<sup>2</sup> copper pad of FR-4 board; 125°C/W when mounted on minimum copper pad.

**N-Channel Electrical Characteristics** (T<sub>C</sub>=25°C, unless otherwise specified)

Symbol	Min.	Typ.	Max.	Unit	Test Conditions
<b>Static</b>					
BV <sub>DSS</sub>	100	-	-	V	V <sub>GS</sub> =0V, I <sub>D</sub> =250μA
V <sub>GS(th)</sub>	1.0	-	2.5		V <sub>DS</sub> =V <sub>GS</sub> , I <sub>D</sub> =250μA
I <sub>GSS</sub>	-	-	±100	nA	V <sub>GS</sub> =±20V, V <sub>DS</sub> =0V
I <sub>DSS</sub>	-	-	1	μA	V <sub>DS</sub> =80V, V <sub>GS</sub> =0V
	-	-	25		V <sub>DS</sub> =80V, V <sub>GS</sub> =0V, T <sub>j</sub> =125°C
*R <sub>DSON</sub>	-	128	165	mΩ	I <sub>D</sub> =2A, V <sub>GS</sub> =10V
	-	135	175		I <sub>D</sub> =1.5A, V <sub>GS</sub> =4.5V
*G <sub>FS</sub>	-	5.5	-	S	V <sub>DS</sub> =10V, I <sub>D</sub> =2A
<b>Dynamic</b>					
C <sub>iss</sub>	-	244	-	pF	V <sub>DS</sub> =30V, V <sub>GS</sub> =0V, f=1MHz
C <sub>oss</sub>	-	34	-		
C <sub>rss</sub>	-	15	-		
*t <sub>d(ON)</sub>	-	4.2	-	ns	V <sub>DS</sub> =50V, I <sub>D</sub> =1A, V <sub>GS</sub> =10V, R <sub>G</sub> =6Ω
*t <sub>r</sub>	-	16.4	-		
*t <sub>d(OFF)</sub>	-	19.4	-		
*t <sub>f</sub>	-	16.6	-		



*Qg	-	7	-	nC	V <sub>DS</sub> =80V, I <sub>D</sub> =2A, V <sub>GS</sub> =10V
*Qgs	-	0.8	-		
*Qgd	-	1.8	-		
<b>Body Diode</b>					
*I <sub>S</sub>	-	-	2.7	A	
*I <sub>SM</sub>	-	-	11		
*V <sub>SD</sub>	-	0.79	1.2	V	V <sub>GS</sub> =0V, I <sub>S</sub> =2A
*trr	-	17.7	-	ns	I <sub>F</sub> =2A, dI <sub>F</sub> /dt=100A/μs
*Qrr	-	14.7	-	nC	

\*Pulse Test : Pulse Width ≤300μs, Duty Cycle ≤2%

**P-Channel Electrical Characteristics (T<sub>C</sub>=25°C, unless otherwise specified)**

Symbol	Min.	Typ.	Max.	Unit	Test Conditions
<b>Static</b>					
BV <sub>DSS</sub>	-100	-	-	V	V <sub>GS</sub> =0V, I <sub>D</sub> =-250μA
V <sub>GS(th)</sub>	-1.0	-	-2.5		V <sub>DS</sub> =V <sub>GS</sub> , I <sub>D</sub> =-250μA
I <sub>GSS</sub>	-	-	±10	nA	V <sub>GS</sub> =±20V, V <sub>DS</sub> =0V
I <sub>DSS</sub>	-	-	-1	μA	V <sub>DS</sub> =-80V, V <sub>GS</sub> =0V
	-	-	-25		V <sub>DS</sub> =-80V, V <sub>GS</sub> =0V, T <sub>J</sub> =125°C
*R <sub>DSON</sub>	-	114	145	mΩ	I <sub>D</sub> =-2A, V <sub>GS</sub> =-10V
	-	133	175		I <sub>D</sub> =-1.5A, V <sub>GS</sub> =-4.5V
*G <sub>FS</sub>	-	6.7	-	S	V <sub>DS</sub> =-10V, I <sub>D</sub> =-2A
<b>Dynamic</b>					
C <sub>iss</sub>	-	774	-	pF	V <sub>DS</sub> =-30V, V <sub>GS</sub> =0V, f=1MHz
C <sub>oss</sub>	-	76	-		
C <sub>rss</sub>	-	39	-		
*td(ON)	-	6.8	-	ns	V <sub>DS</sub> =-50V, I <sub>D</sub> =-1A, V <sub>GS</sub> =-10V, R <sub>G</sub> =6Ω
*tr	-	17.4	-		
*td(OFF)	-	56.8	-		
*tf	-	32	-		
*Qg	-	17.9	-	nC	V <sub>DS</sub> =-80V, I <sub>D</sub> =-2A, V <sub>GS</sub> =-10V
*Qgs	-	1.9	-		
*Qgd	-	4.9	-		
<b>Body Diode</b>					
*I <sub>S</sub>	-	-	-3	A	
*I <sub>SM</sub>	-	-	-12		
*V <sub>SD</sub>	-	-0.78	-1.2	V	V <sub>GS</sub> =0V, I <sub>S</sub> =-2.5A
*trr	-	17.5	-	ns	I <sub>F</sub> =-2A, dI <sub>F</sub> /dt=100A/μs
*Qrr	-	15.2	-	nC	

\*Pulse Test : Pulse Width ≤300μs, Duty Cycle ≤2%

### Recommended Soldering Footprint

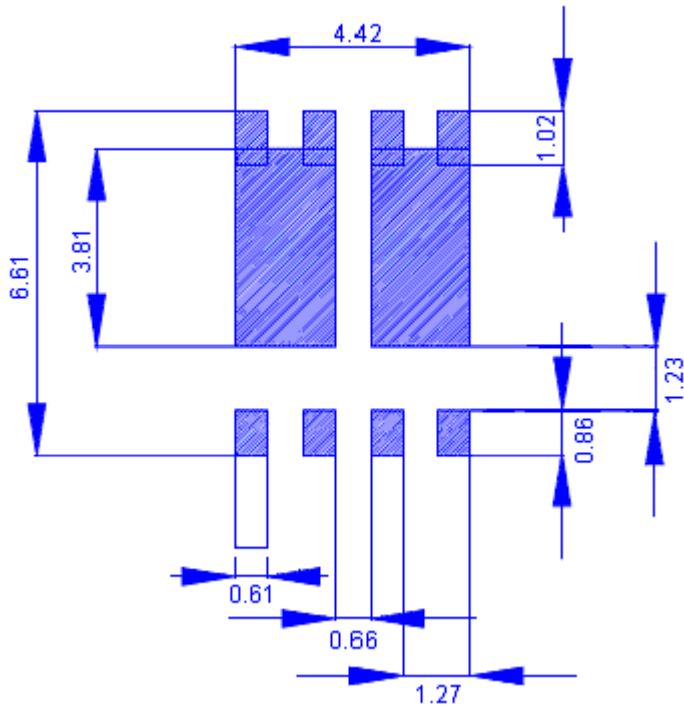

unit : mm

**Recommended Stencil Design**

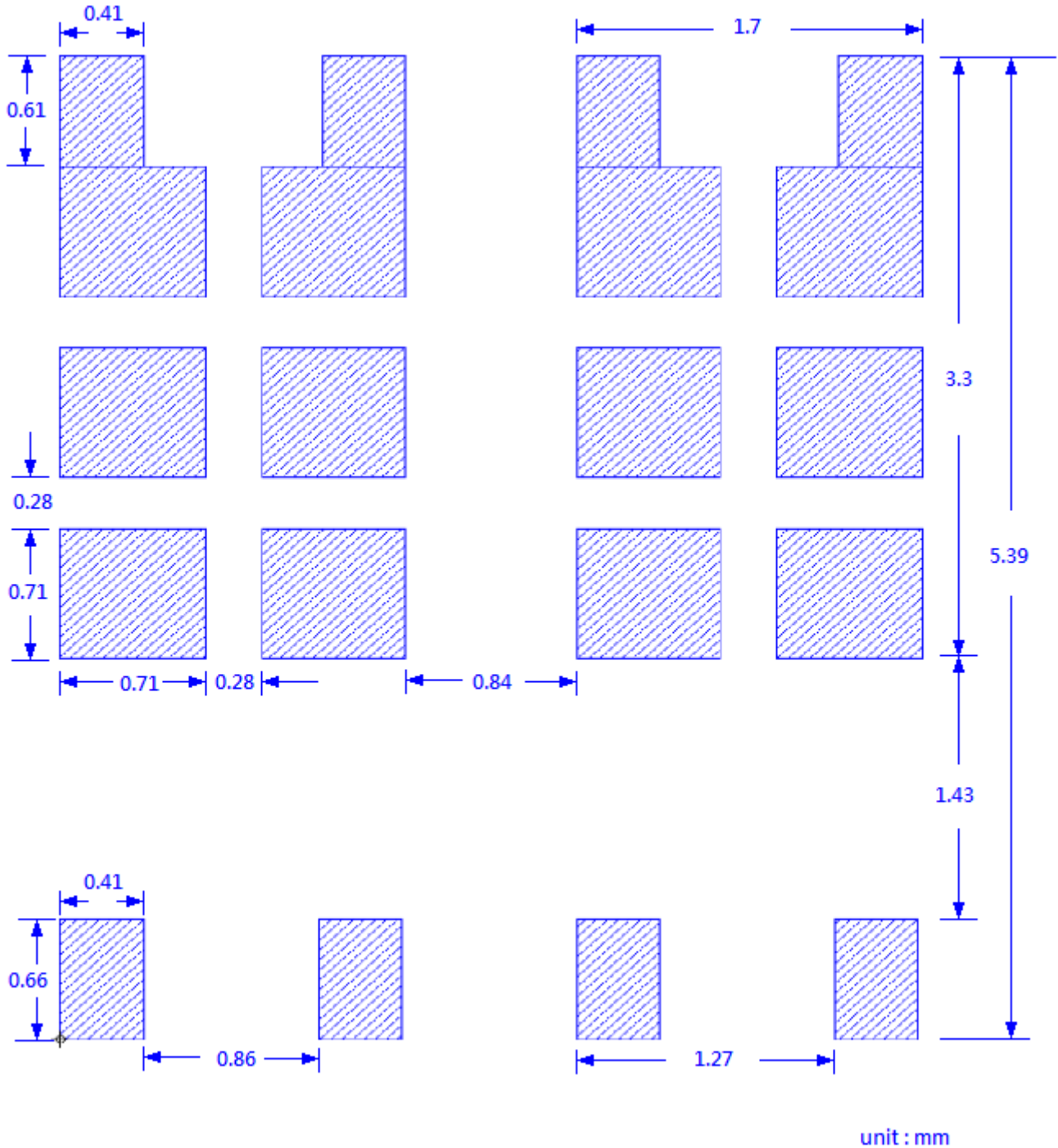

- Note :**
1. Stencil thickness 5 mil (0.127mm)
  2. May need to be adjusted to specific requirements.

**Typical Characteristics : Q1( N-channel )**

Typical Output Characteristics

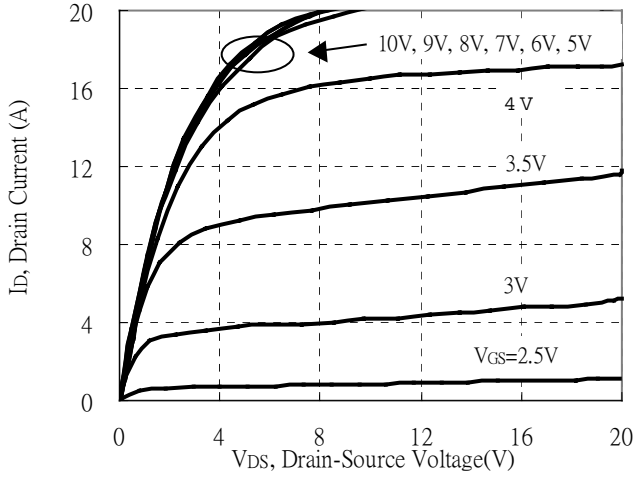

Brekdown Voltage vs Ambient Temperature

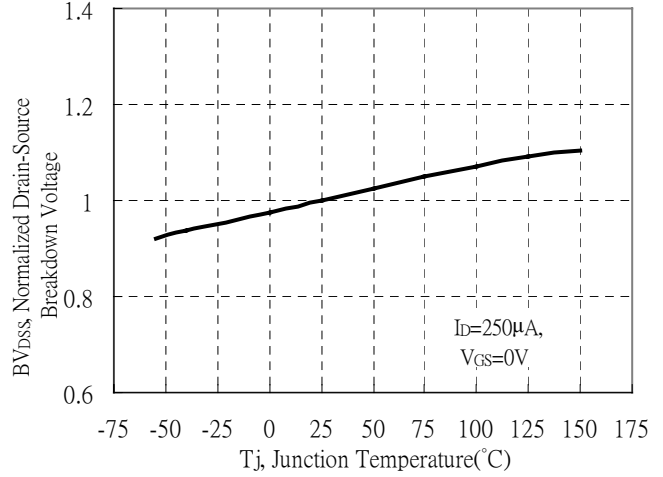

Static Drain-Source On-State resistance vs Drain Current

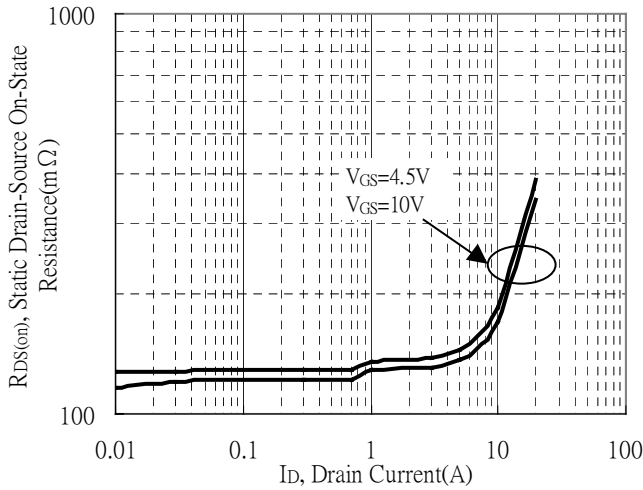

Reverse Drain Current vs Source-Drain Voltage

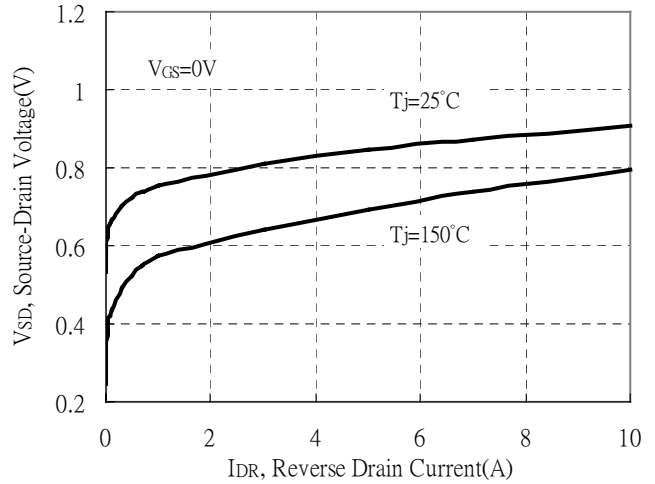

Static Drain-Source On-State Resistance vs Gate-Source Voltage

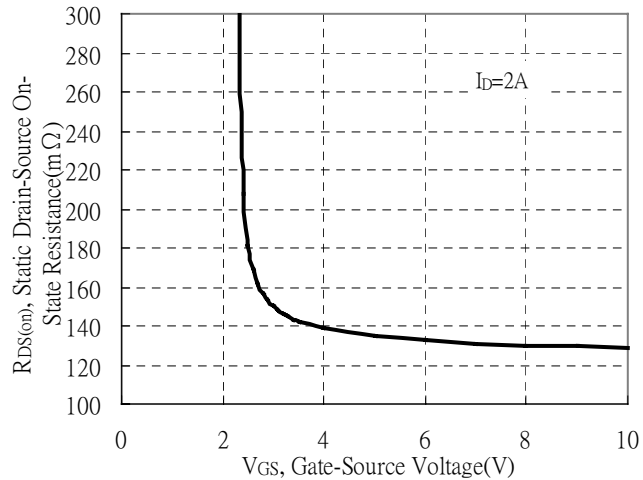

Drain-Source On-State Resistance vs Junction Temperature

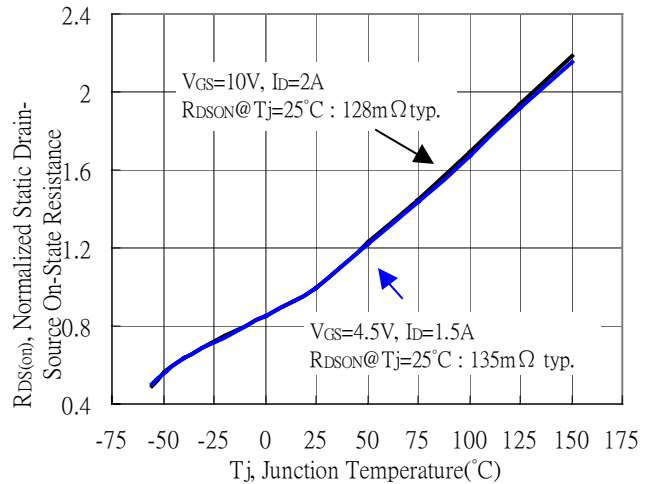

**Typical Characteristics(Cont.) : Q1( N-channel)**

Capacitance vs Drain-to-Source Voltage

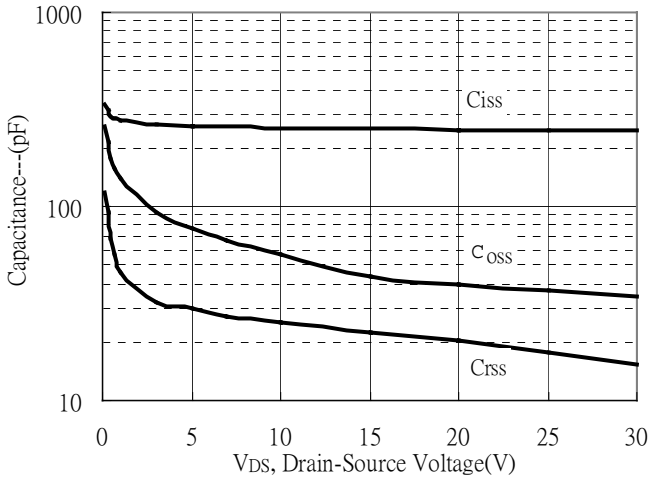

Threshold Voltage vs Junction Temperature

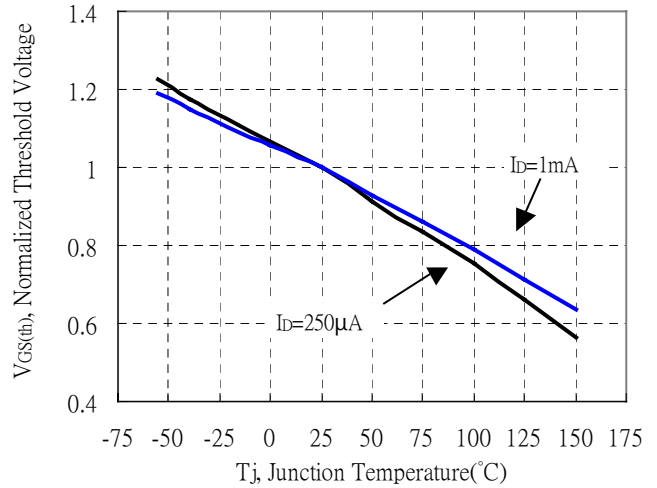

Forward Transfer Admittance vs Drain Current

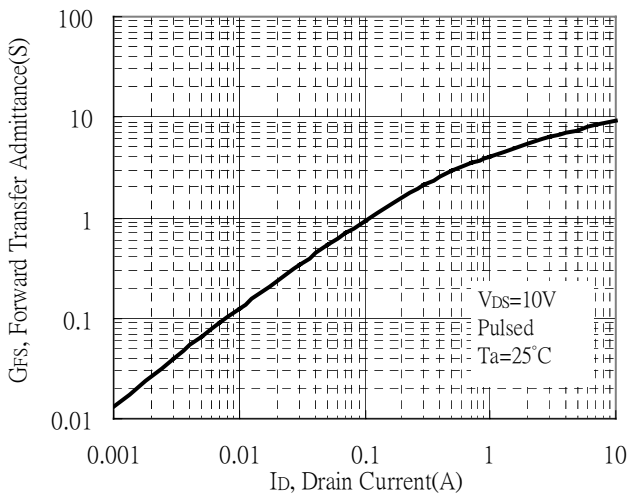

Gate Charge Characteristics

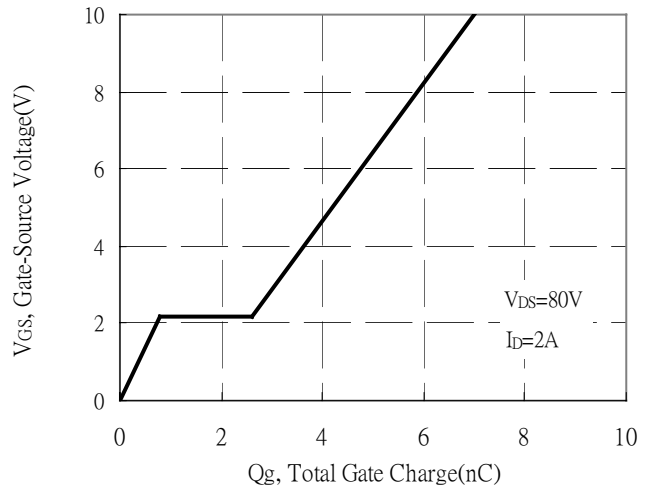

Maximum Safe Operating Area

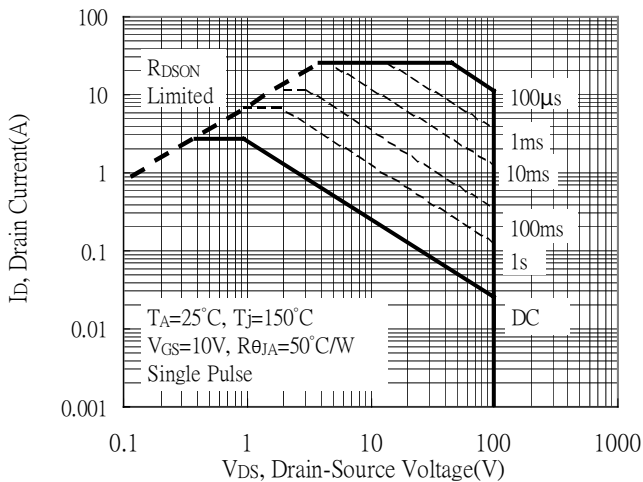

Maximum Drain Current vs Case Temperature

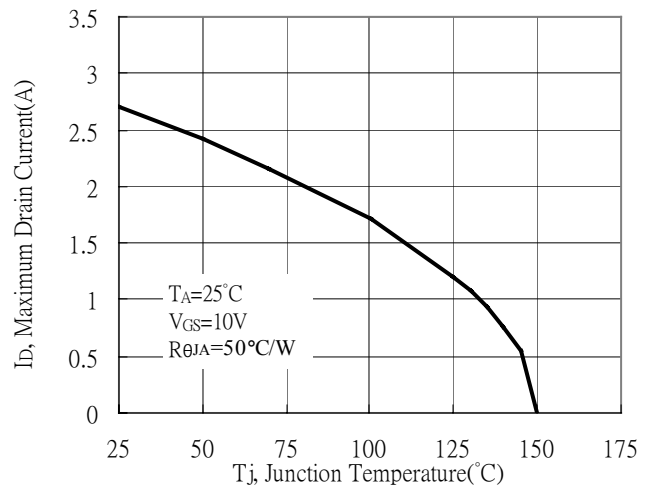



**Typical Characteristics(Cont.) : Q1( N-channel)**

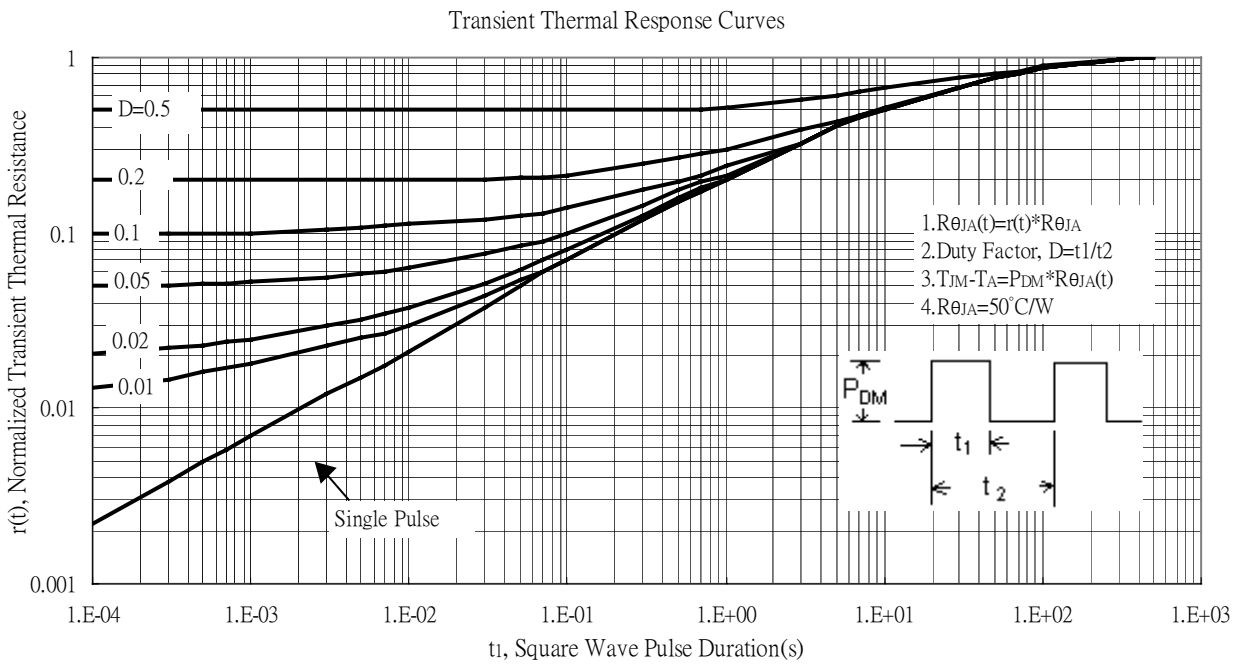
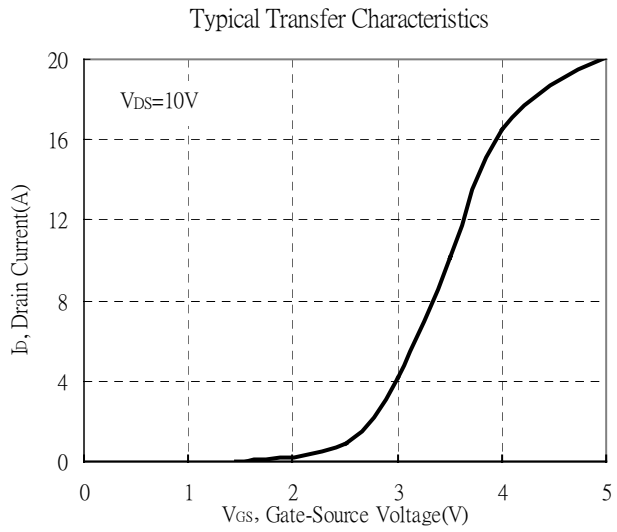
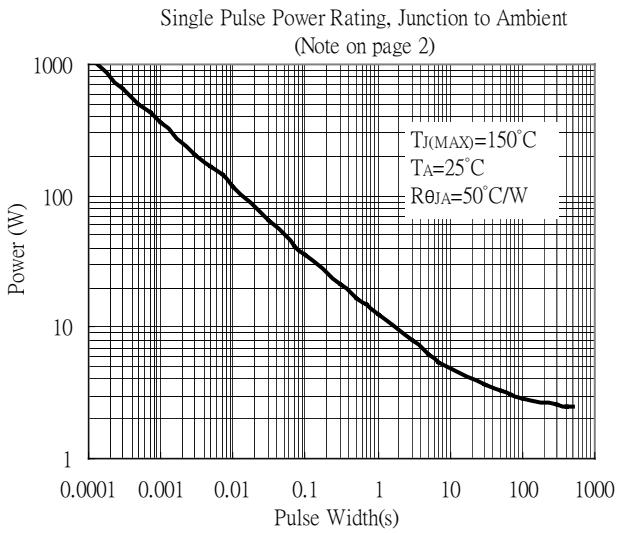





**Typical Characteristics : Q2( P-channel)**

Typical Output Characteristics

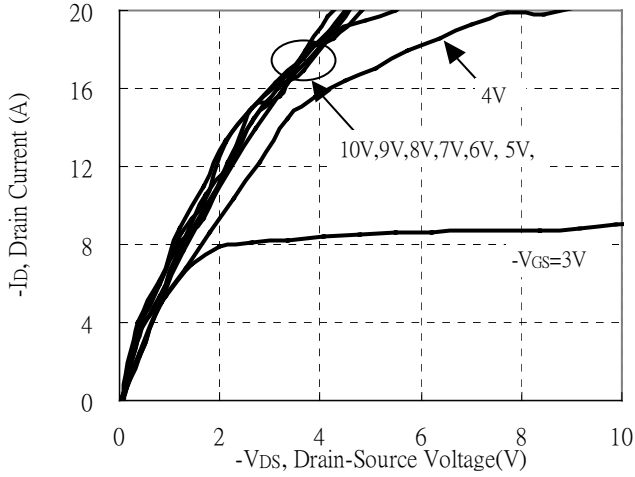

Breakdown Voltage vs Ambient Temperature

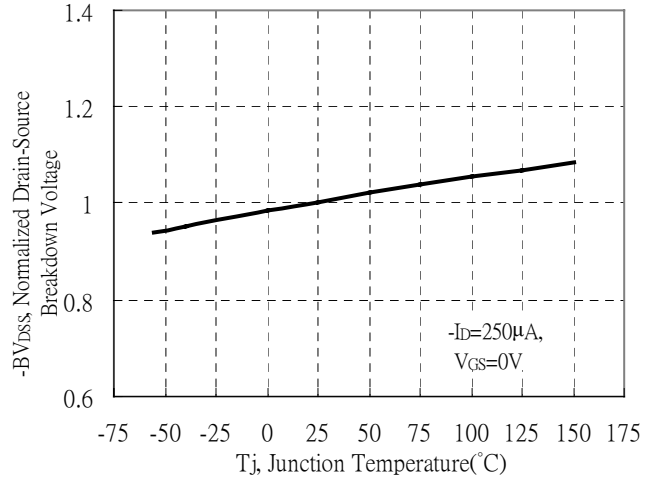

Static Drain-Source On-State resistance vs Drain Current

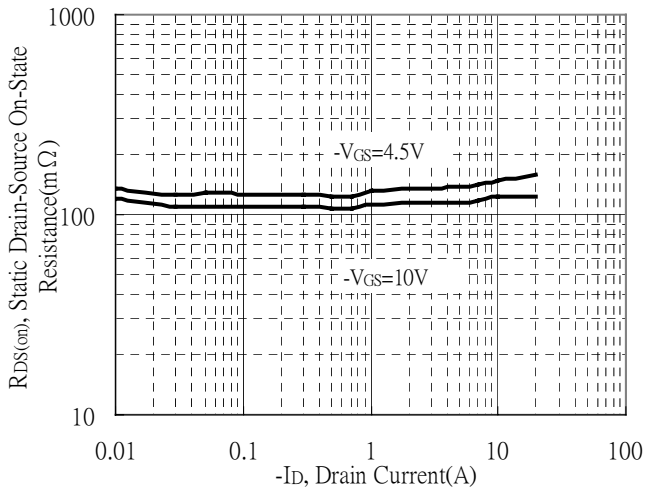

Reverse Drain Current vs Source-Drain Voltage

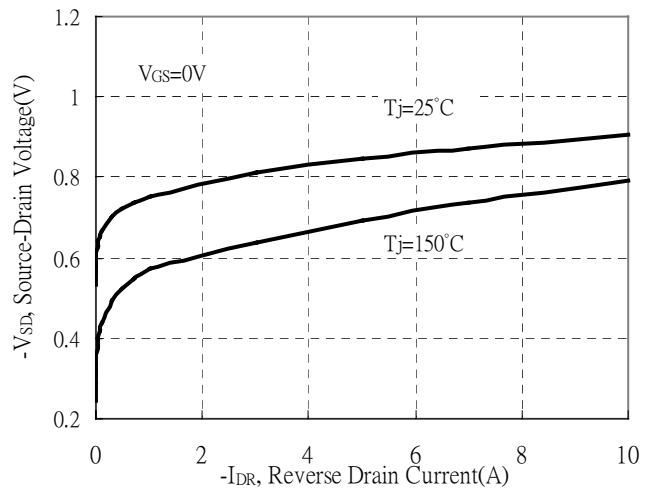

Static Drain-Source On-State Resistance vs Gate-Source Voltage

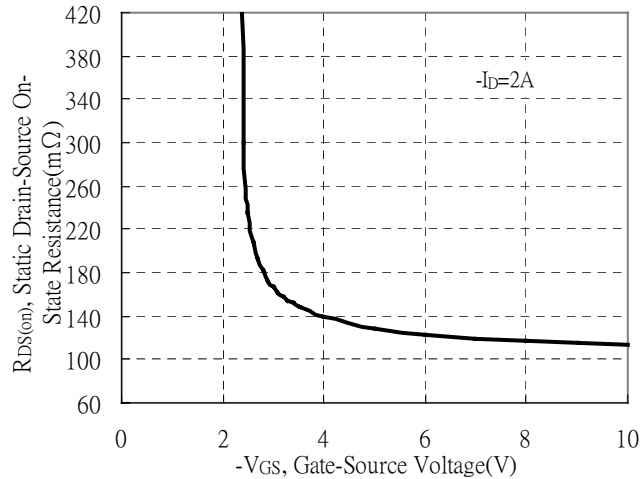

Drain-Source On-State Resistance vs Junction Temperature

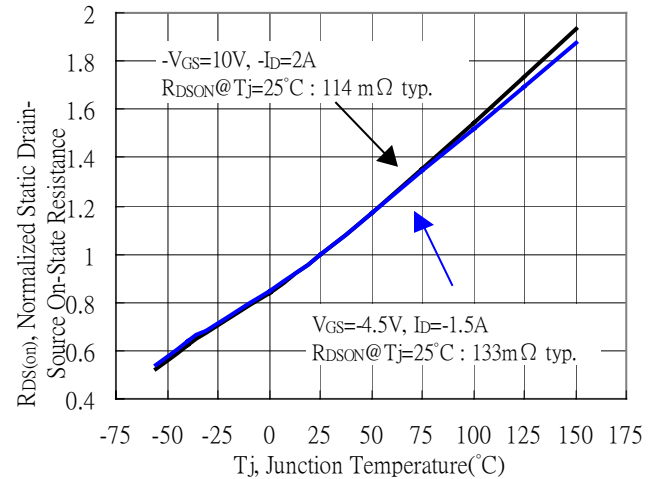

**Typical Characteristics(Cont.) : Q2(P-channel)**

Capacitance vs Drain-to-Source Voltage

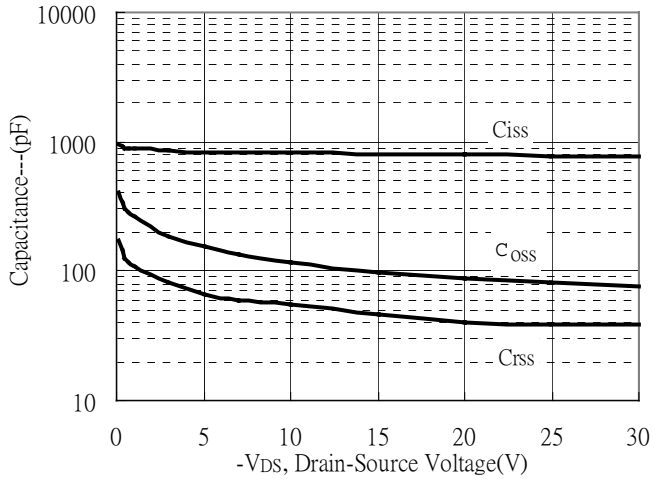

Threshold Voltage vs Junction Temperature

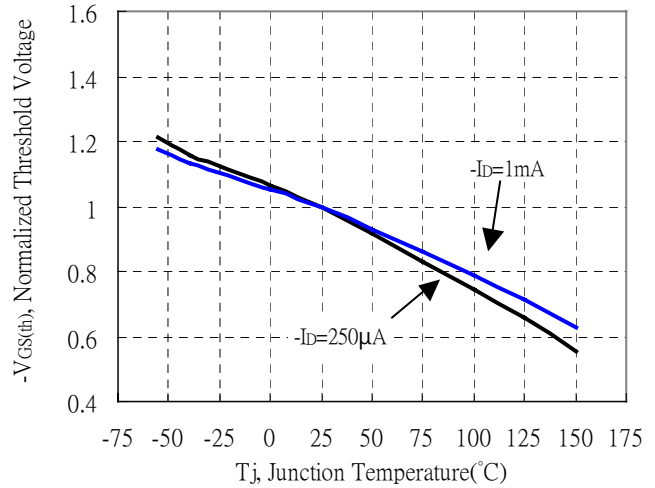

Forward Transfer Admittance vs Drain Current

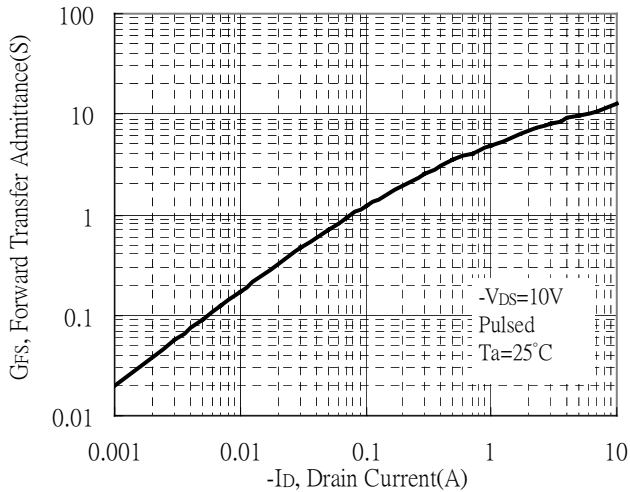

Gate Charge Characteristics

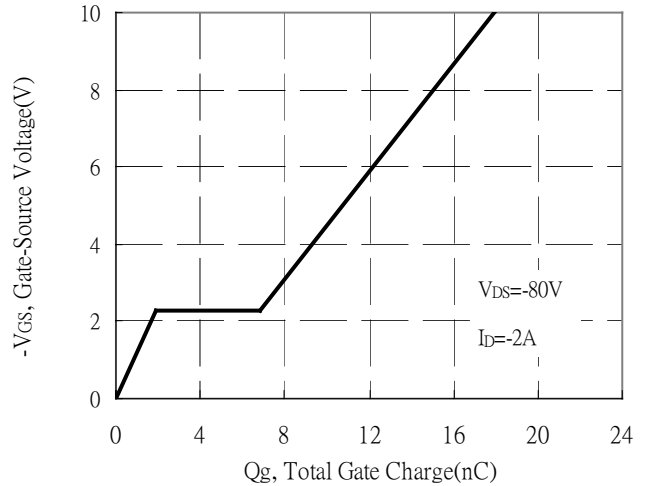

Maximum Safe Operating Area

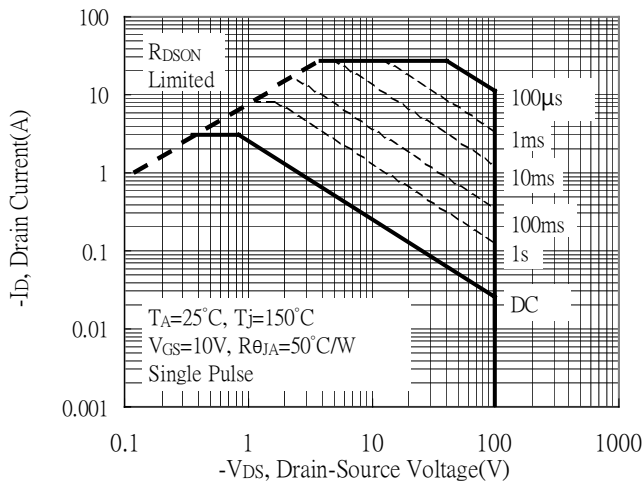

Maximum Drain Current vs Case Temperature

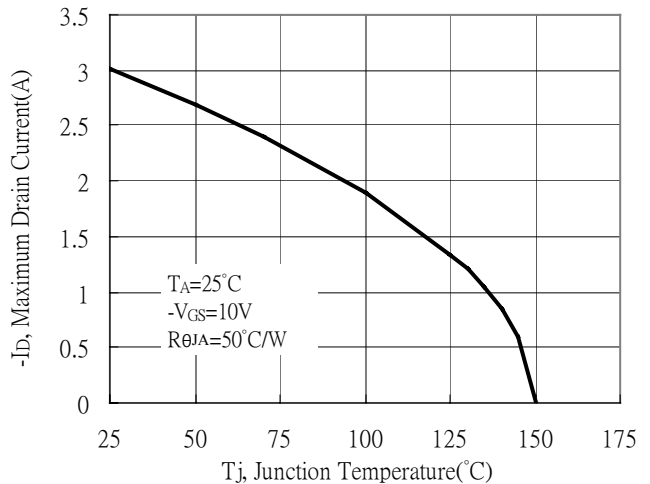

**Typical Characteristics(Cont.) : Q2(P-channel)**

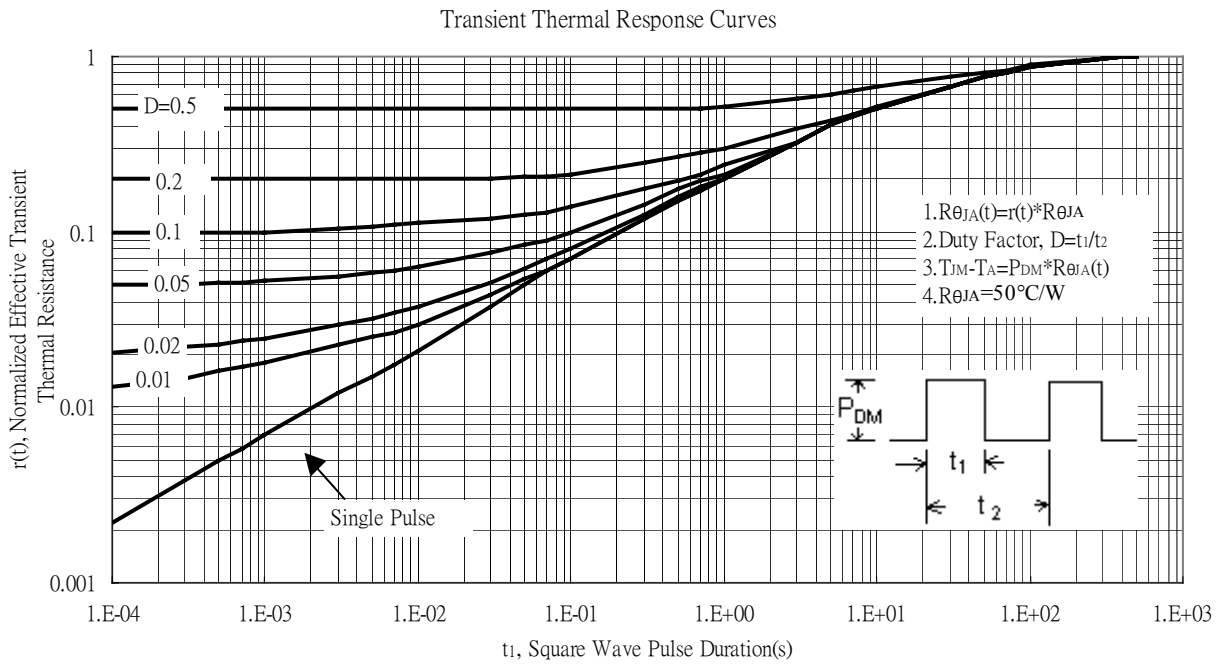
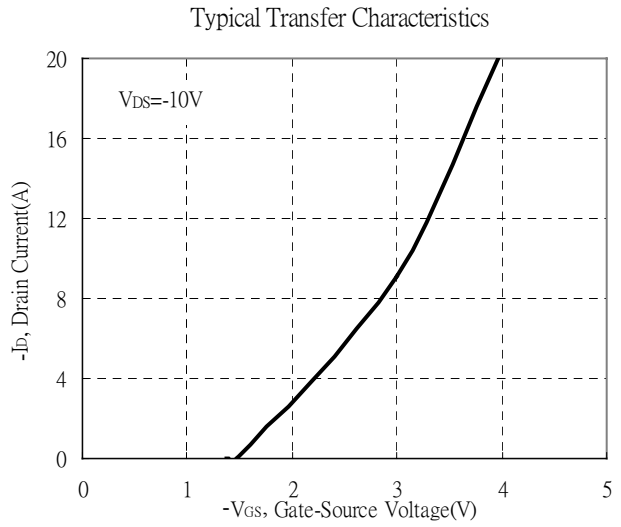
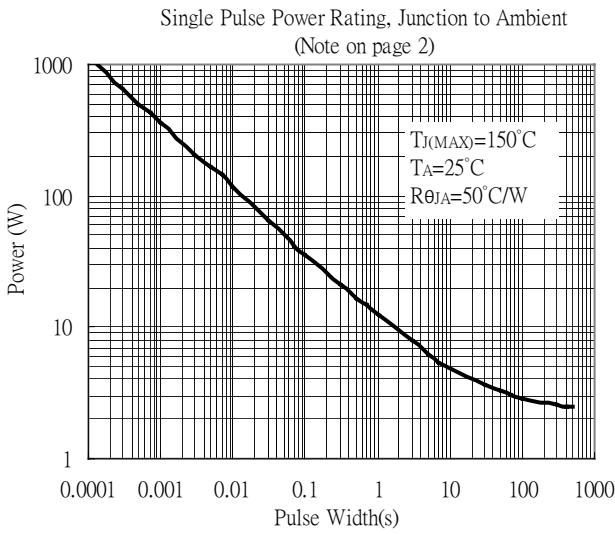

**Reel Dimension**

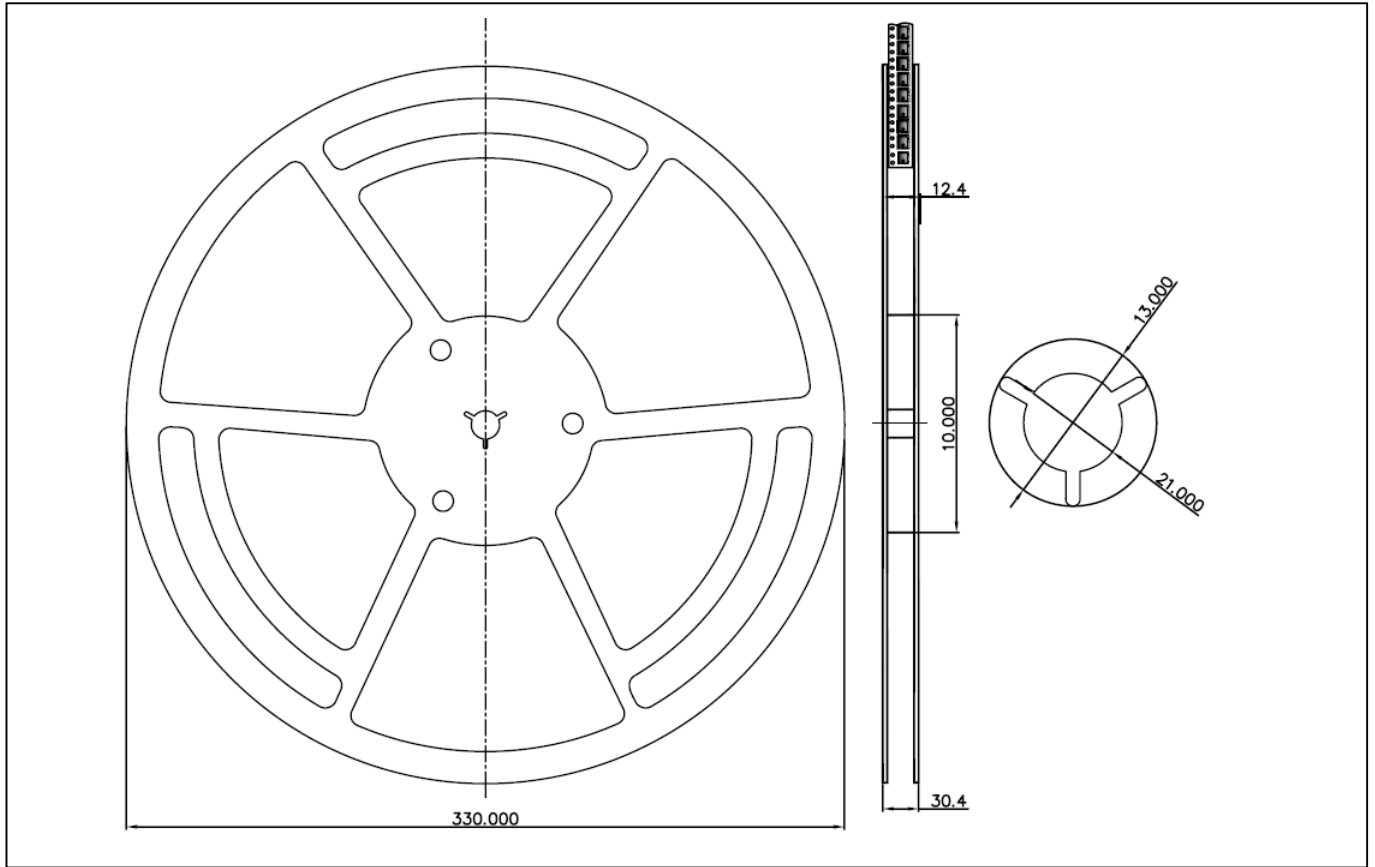

**Carrier Tape Dimension**

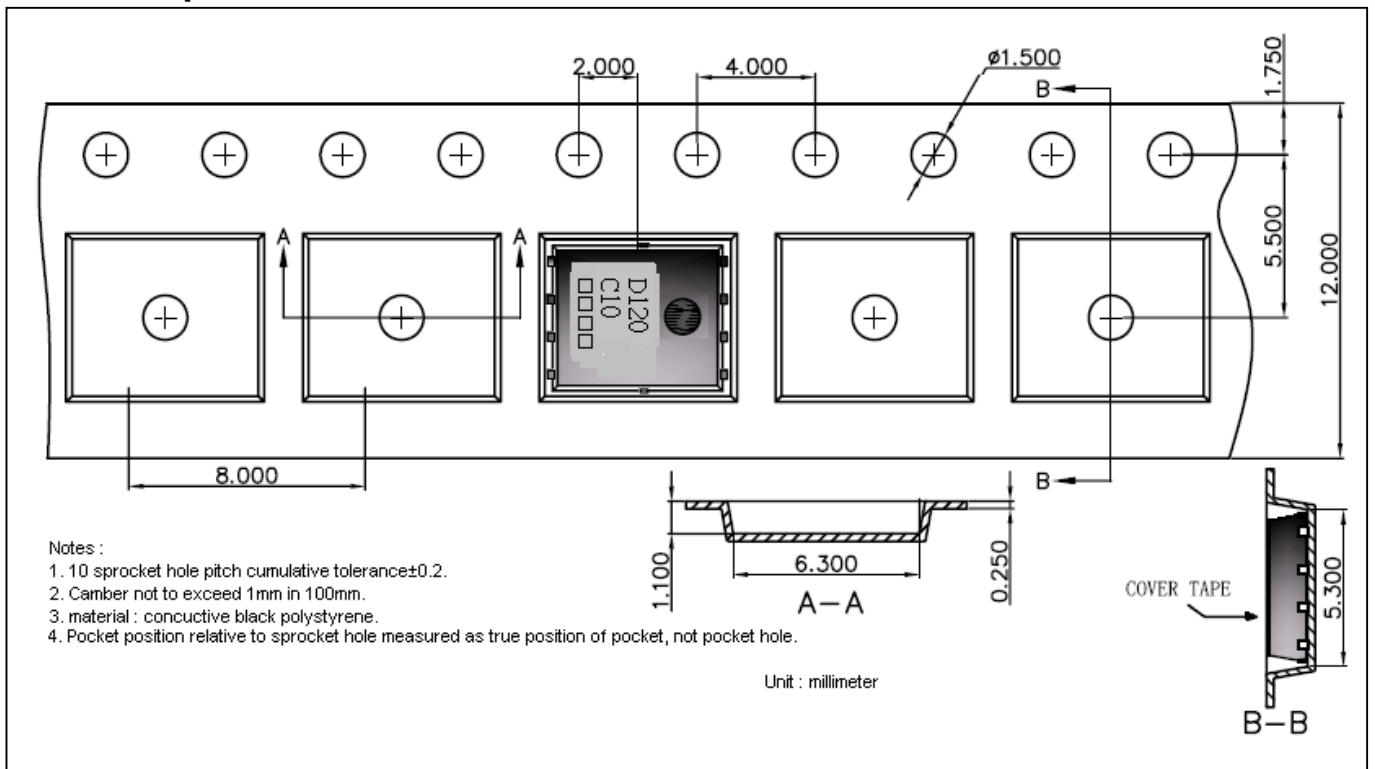

**Recommended wave soldering condition**

Product	Peak Temperature	Soldering Time
Pb-free devices	260 +0/-5 °C	5 +1/-1 seconds

**Recommended temperature profile for IR reflow**

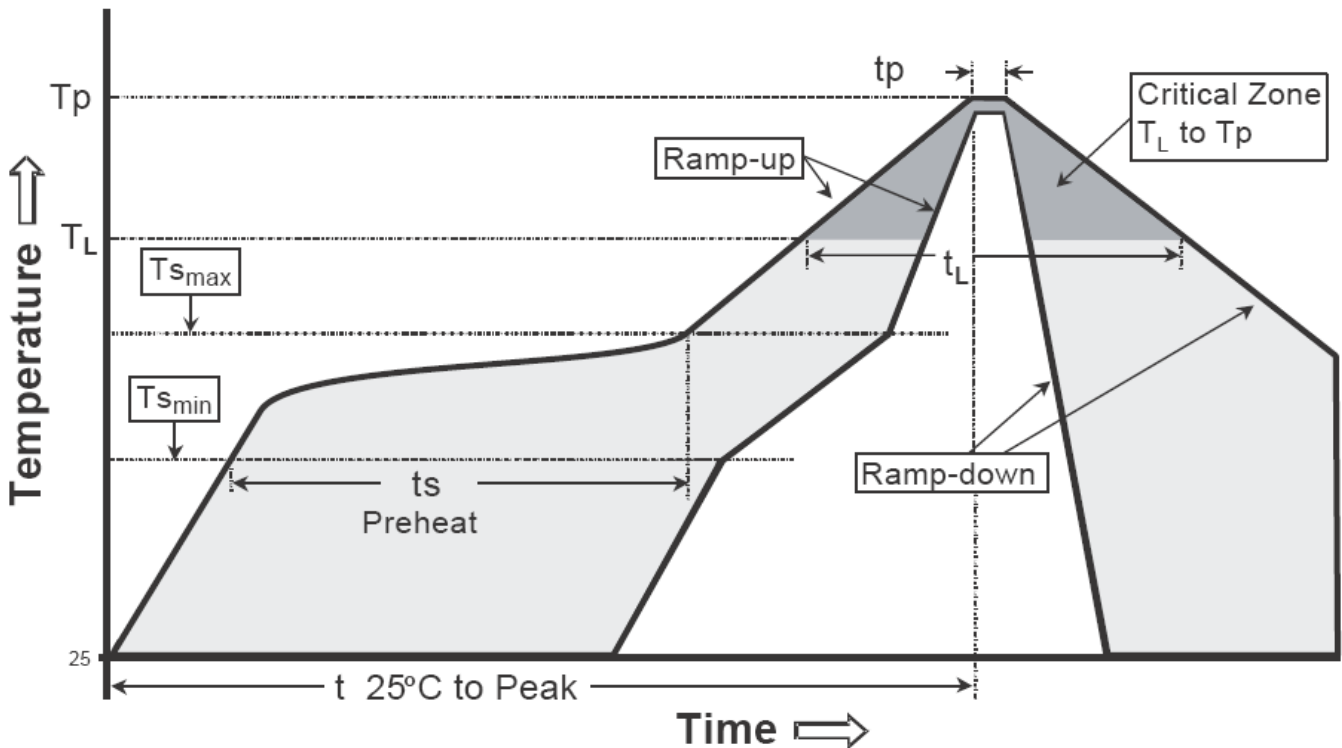

Profile feature	Sn-Pb eutectic Assembly	Pb-free Assembly
Average ramp-up rate (Tsmax to Tp)	3°C/second max.	3°C/second max.
Preheat		
-Temperature Min(Ts min)	100°C	150°C
-Temperature Max(Ts max)	150°C	200°C
-Time(ts min to ts max)	60-120 seconds	60-180 seconds
Time maintained above:		
-Temperature (TL)	183°C	217°C
- Time (tL)	60-150 seconds	60-150 seconds
Peak Temperature(TP)	240 +0/-5 °C	260 +0/-5 °C
Time within 5°C of actual peak temperature(tp)	10-30 seconds	20-40 seconds
Ramp down rate	6°C/second max.	6°C/second max.
Time 25 °C to peak temperature	6 minutes max.	8 minutes max.

Note : All temperatures refer to topside of the package, measured on the package body surface.

**DFN5x6 Dimension**

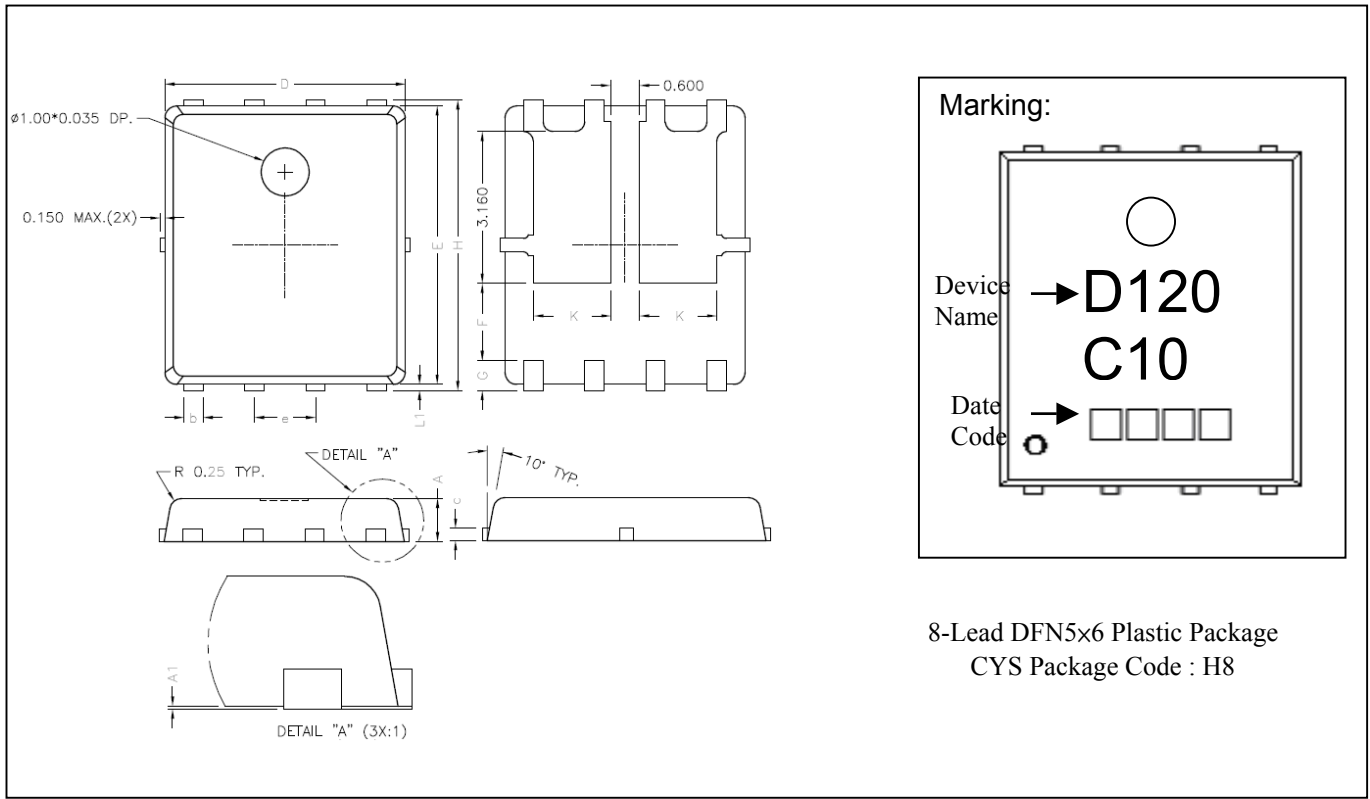

8-Lead DFN5x6 Plastic Package  
 CYS Package Code : H8

DIM	Millimeters		Inches		DIM	Millimeters		Inches	
	Min.	Max.	Min.	Max.		Min.	Max.	Min.	Max.
A	0.80	1.00	0.031	0.039	E	5.70	5.90	0.224	0.232
A1	0.00	0.05	0.000	0.002	e	1.27	BSC	0.050	BSC
b	0.35	0.49	0.014	0.019	H	5.95	6.20	0.234	0.244
c	0.254	REF	0.010	REF	L1	0.10	0.18	0.004	0.007
D	4.90	5.10	0.193	0.201	G	0.60	REF	0.024	REF
F	1.60	REF	0.063	REF	K	1.60	REF	0.063	REF

Notes: 1.Controlling dimension: millimeters.  
 2.Maximum lead thickness includes lead finish thickness, and minimum lead thickness is the minimum thickness of base material.  
 3.If there is any question with packing specification or packing method, please contact your local CYStek sales office.

**Material:**

- Lead: Pure tin plated.
- Mold Compound: Epoxy resin family, flammability solid burning class: UL94V-0.

**Important Notice:**

- All rights are reserved. Reproduction in whole or in part is prohibited without the prior written approval of CYStek.
- CYStek reserves the right to make changes to its products without notice.
- CYStek **semiconductor products are not warranted to be suitable for use in Life-Support Applications, or systems.**
- CYStek assumes no liability for any consequence of customer product design, infringement of patents, or application assistance.