

Spezifikation für Freigabe / specification for release

Kunde / customer :
 Artikelnummer / part number : **7440320027**
 Bezeichnung : **SMD HF-Drossel WE-LQ**
 description : **SMD HF-CHOKE WE-LQ**



DATUM / DATE : 2006-07-14

A Mechanische Abmessungen / dimensions:

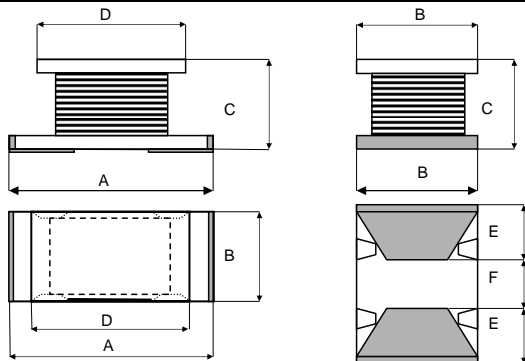

	Typ M	
A	3,2 ± 0,3	mm
B	2,5 ± 0,3	mm
C	2,0 ± 0,3	mm
D	2,4±0,3	mm
E	1,0 ref	mm
F	1,3 typ	mm
G	3,8 ref	mm
H	2,8 ref	mm

Marking = Inductance code

B Elektrische Eigenschaften / electrical properties:

Eigenschaften / properties	Testbedingungen / test conditions		Wert / value	Einheit / unit	tol.
Induktivität / inductance	1 MHz / 0,1V	L	2,70	μH	± 20%
Güte Q / Q factor	1 MHz / 0,1V	Q	20		ref.
DC-Widerstand / DC-resistance	@ 20°C	R _{DC}	0,180	Ω	max.
Nennstrom / rated current	ΔT= 40 K	I _{DC}	0,600	A	max.
Sättigungsstrom / saturation current	 ΔL/L <10%	I _{sat}	1,600	A	typ.
Eigenres.-Frequenz / self-res.-frequency		SRF	43,0	MHz	typ.

C Lötpad / soldering spec.:

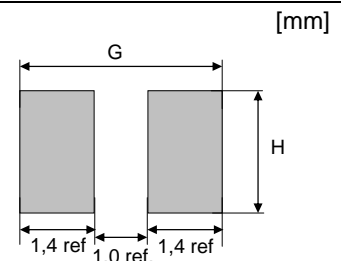

D Prüfgeräte / test equipment:

HP 4274 A für/for L und/and Q
HP 34401 A für/for R_{DC} und I_{DC}

E Testbedingungen / test conditions:

Luftfeuchtigkeit / humidity: 33%
 Umgebungstemperatur / temperature: +20°C

F Werkstoffe & Zulassungen / material & approvals:

Basismaterial / base material: Ferrit
 Draht / wire: Class F
 Pin / Terminal: Sn/Cu - 99,3/0,7%

G Eigenschaften / general specifications:

Betriebstemp. / operating temperature: -40°C - + 125°C
 Umgebungstemp. / ambient temperature: -40°C - + 85°C
 It is recommended that the temperature of the part does not exceed 125°C under worst case operating conditions.

Freigabe erteilt / general release:	Kunde / customer				
Datum / date	Unterschrift / signature				
	Würth Elektronik				
			UB	Version 3	06-07-14
			MST	Version 1	04-10-11
Geprüft / checked	Kontrolliert / approved		Name	Änderung / modification	Datum / date

Würth Elektronik eiSos GmbH & Co.KG

D-74638 Waldenburg · Max-Eyth-Strasse 1 - 3 · Germany · Telefon (+49) (0) 7942 - 945 - 0 · Telefax (+49) (0) 7942 - 945 - 400
<http://www.we-online.com>

Spezifikation für Freigabe / specification for release

Kunde / customer :
 Artikelnummer / part number : **7440320027**
 Bezeichnung : **SMD HF-Drossel WE-LQ**
 description : **SMD HF-CHOKE WE-LQ**



DATUM / DATE : 2006-07-14

H Induktivitätskurve / Inductance curve :

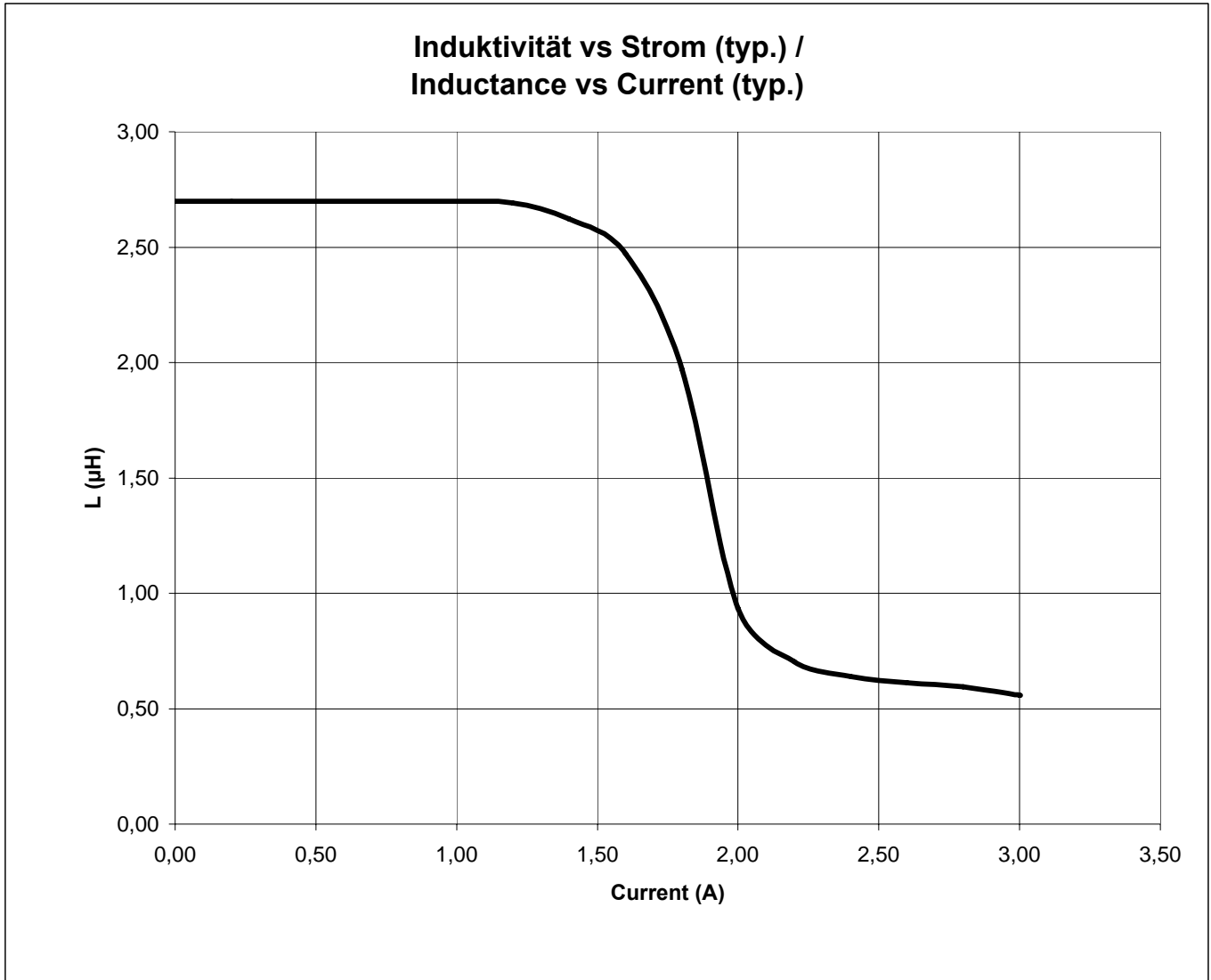

Freigabe erteilt / general release:	Kunde / customer			
.....			
Datum / date	Unterschrift / signature			
.....			
	Würth Elektronik			
.....			
Geprüft / checked	Kontrolliert / approved	Name	Änderung / modification	Datum / date
		UB	Version 3	06-07-14
		MST	Version 1	04-10-11

Würth Elektronik eiSos GmbH & Co.KG

D-74638 Waldenburg · Max-Eyth-Strasse 1 - 3 · Germany · Telefon (+49) (0) 7942 - 945 - 0 · Telefax (+49) (0) 7942 - 945 - 400
<http://www.we-online.com>

Spezifikation für Freigabe / specification for release

Kunde / customer :
 Artikelnummer / part number : **7440320027**
 Bezeichnung : **SMD HF-Drossel WE-LQ**
 description : **SMD HF-CHOKE WE-LQ**



DATUM / DATE : 2006-07-14

I Rollenspezifikation / tape and reel specification:

Gurtspezifikation / Tape specification:

A	4,00 ± 0,1	mm
B	4,00 ± 0,1	mm

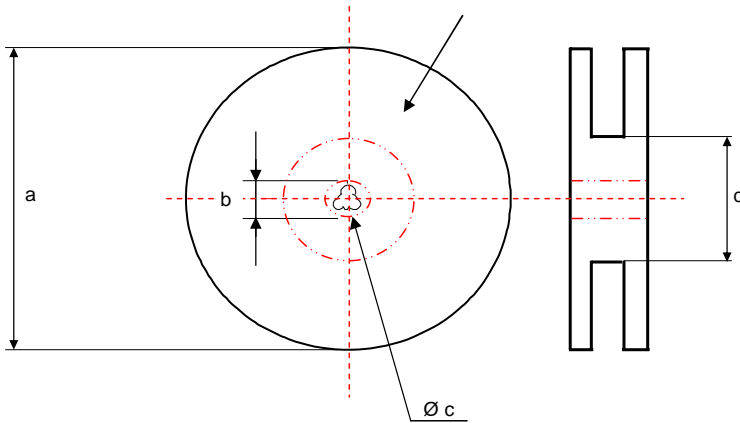
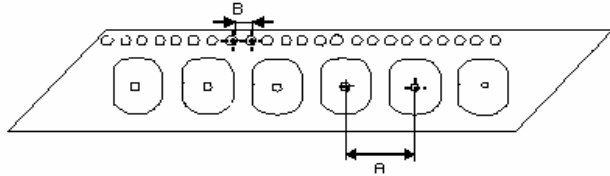

Rollenspezifikation / Reel specification:

a	178 ± 0,5	mm
b	20,20 ± 0,1	mm
c	13,00 ^{+0,5} - 1,0	mm
d	50,0 ± 1,0	mm

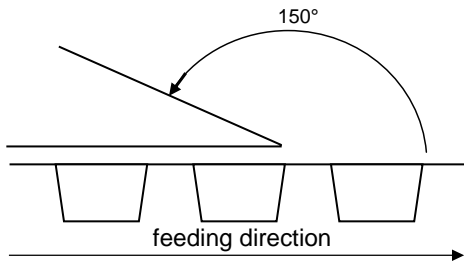

The force for tearing off cover tape is 20 to 70 grams in arrow direction

Freigabe erteilt / general release:	Kunde / customer		
Datum / date	Unterschrift / signature		
	Würth Elektronik		
Geprüft / checked	Kontrolliert / approved		
	Name	Änderung / modification	Datum / date
	UB	Version 3	06-07-14
	MST	Version 1	04-10-11

This electronic component has been designed and developed for usage in general electronic equipment. Before incorporating this component into any equipment where higher safety and reliability is especially required or if there is the possibility of direct damage or injury to human body, for example in the range of aerospace, aviation, nuclear control, submarine, transportation, (automotive control, train control, ship control), transportation signal, disaster prevention, medical, public information network etc, Würth Elektronik eiSos GmbH must be informed before the design-in stage. In addition, sufficient reliability evaluation checks for safety must be performed on every electronic component which is used in electrical circuits that require high safety and reliability functions or performance

Würth Elektronik eiSos GmbH & Co.KG

D-74638 Waldenburg · Max-Eyth-Strasse 1 - 3 · Germany · Telefon (+49) (0) 7942 - 945 - 0 · Telefax (+49) (0) 7942 - 945 - 400
<http://www.we-online.com>