



GaAs MMIC 6-BIT DIGITAL PHASE SHIFTER, 2.5 - 3.1 GHz

Typical Applications

The HMC647ALP6E is ideal for:

- EW Receivers
- Weather & Military Radar
- Satellite Communications
- Beamforming Modules
- Phase Cancellation

Features

- Low RMS Phase Error: 1.5°
- Low Insertion Loss: 4 dB
- High Linearity: +50 dBm
- Positive Control Logic
- 360° Coverage, LSB = 5.625°
- 28 Lead QFN Leadless SMT Package: 36mm²

Functional Diagram

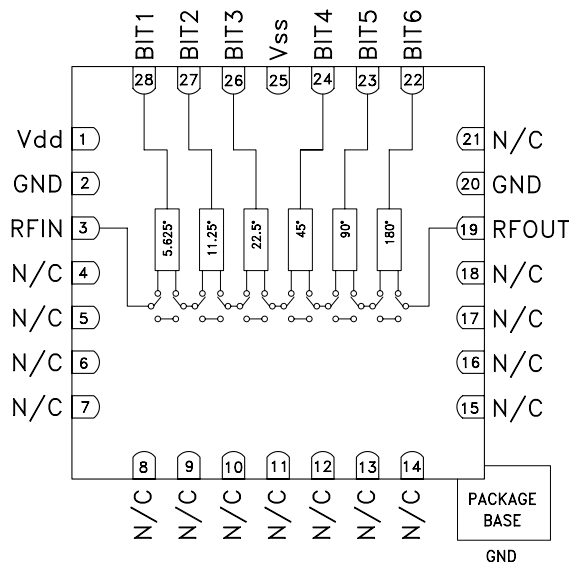

General Description

The HMC647ALP6E is a 6-bit digital phase shifter which is rated from 2.5 to 3.1 GHz, providing 360 degrees of phase coverage, with a LSB of 5.625 degrees. The HMC647ALP6E features very low RMS phase error of 1.5 degrees and extremely low insertion loss variation of ±0.4 dB across all phase states. This high accuracy phase shifter is controlled with positive control logic of 0/+5V. The HMC647ALP6E is housed in a compact 6x6 mm plastic leadless SMT package and is internally matched to 50 Ohms with no external components.

Electrical Specifications

$T_A = +25^\circ\text{C}$, $V_{SS} = -5\text{V}$, $V_{DD} = +5\text{V}$, control Voltage = 0/ +5V, 50 Ohm System

Parameter	Min.	Typ.	Max.	Units
Frequency Range	2.5		3.1	GHz
Insertion Loss*		4	6.5	dB
Input Return Loss*		16		dB
Output Return Loss*		16		dB
Phase Error*		±5	+6 / -15	deg
RMS Phase Error		1.5		deg
Insertion Loss Variation*		±0.4		dB
Input Power for 1 dB Compression		31		dBm
Input Third Order Intercept		50		dBm
Control Voltage Current		35	250	µA
Bias Control Current		5	15	mA

*Note: Major States Shown



**GaAs MMIC 6-BIT DIGITAL
PHASE SHIFTER, 2.5 - 3.1 GHz**

Insertion Loss, Major States Only

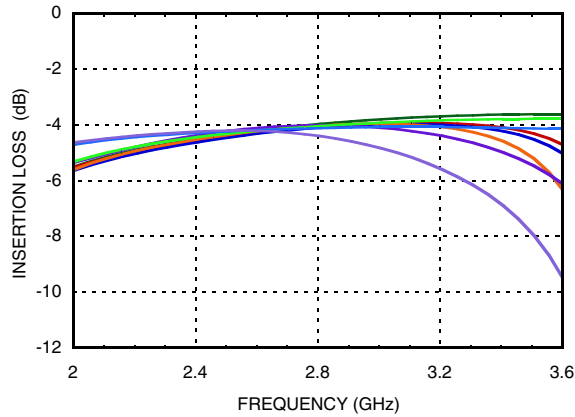

Normalized Loss, Major States Only

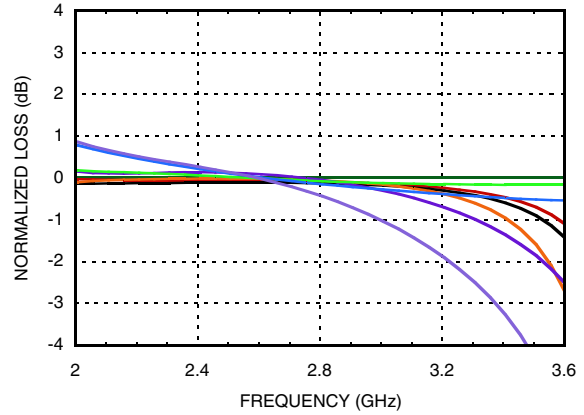

Input Return Loss, Major States Only

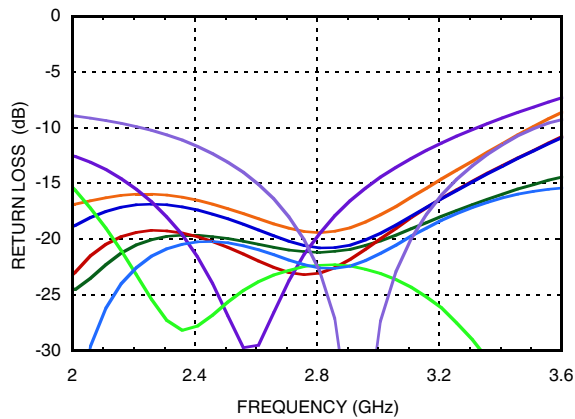

Phase Error, Major States Only

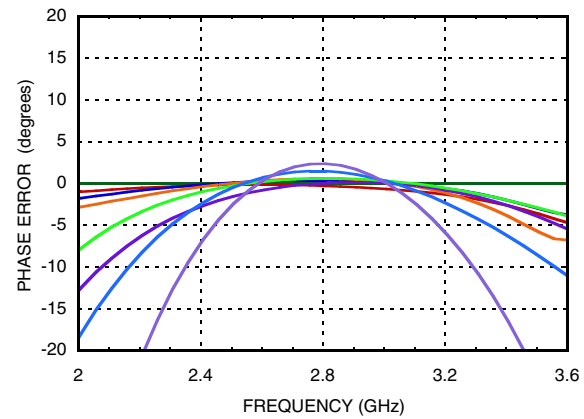

Output Return Loss, Major States Only

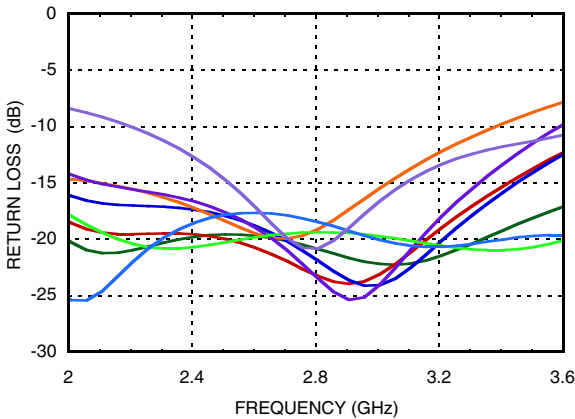

**Relative Phase Shift
Major States Including All Bits**

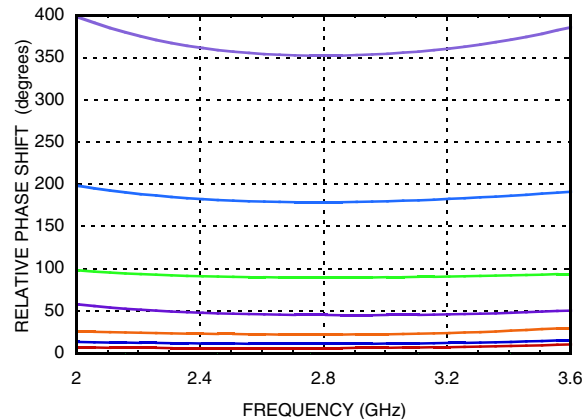



**GaAs MMIC 6-BIT DIGITAL
PHASE SHIFTER, 2.5 - 3.1 GHz**

**Relative Phase Shift,
RMS, Average, Max, All States**

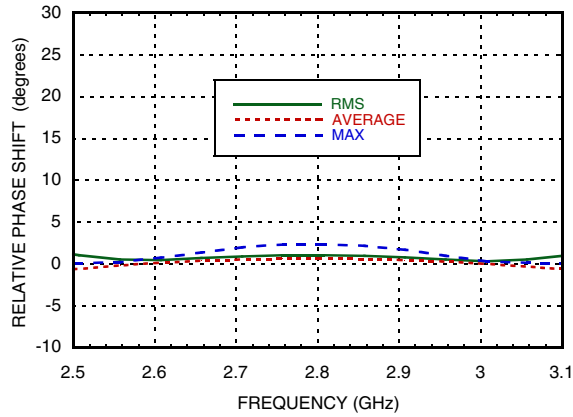

Input IP3, Major States Only

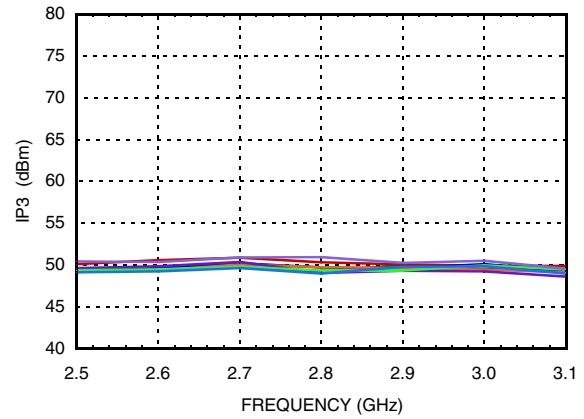

Input IP2, Major States Only

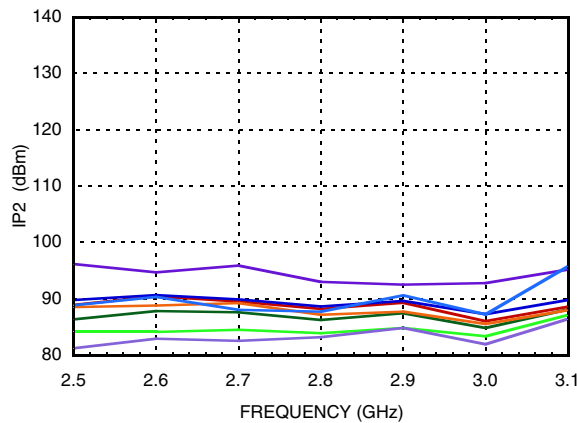

Input P1dB, Major States Only

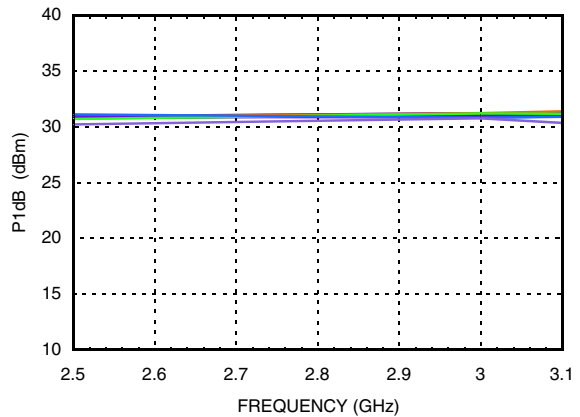

RMS Phase Error vs. Temperature

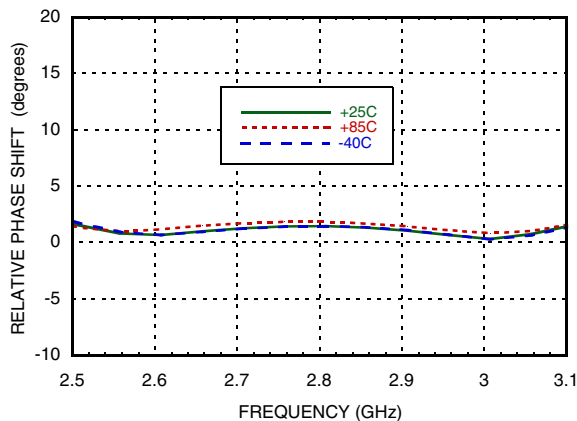

**Insertion Loss vs. Temperature,
Major States Only**

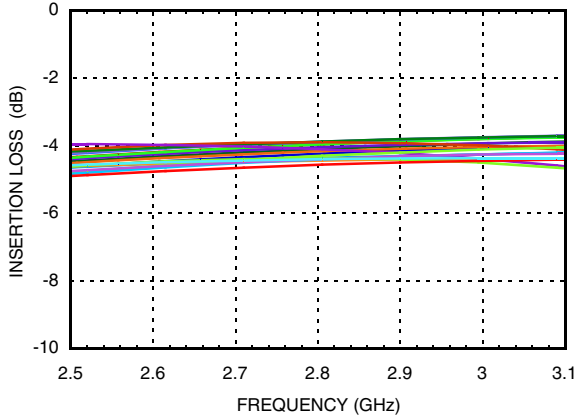

Information furnished by Analog Devices is believed to be accurate and reliable. However, no responsibility is assumed by Analog Devices for its use, nor for any infringements of patents or other rights of third parties that may result from its use. Specifications subject to change without notice. No license is granted by implication or otherwise under any patent or patent rights of Analog Devices. Trademarks and registered trademarks are the property of their respective owners.

For price, delivery, and to place orders: Analog Devices, Inc., One Technology Way, P.O. Box 9106, Norwood, MA 02062-9106 Phone: 781-329-4700 • Order online at www.analog.com Application Support: Phone: 1-800-ANALOG-D

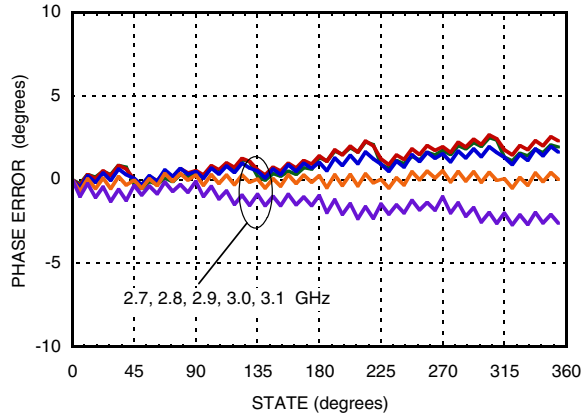
**GaAs MMIC 6-BIT DIGITAL
PHASE SHIFTER, 2.5 - 3.1 GHz**
Phase Error vs. State

Bias Voltage & Current

Vdd	Idd
5.0	5.3mA
Vss	Iss
-5.0	5.3mA

Control Voltage

State	Bias Condition
Low (0)	0 to 0.2 Vdc
High (1)	Vdd ±0.2 Vdc @ 35 µA Typ.

Absolute Maximum Ratings

Input Power (RFIN)	33 dBm (T= +85 °C)
Bias Voltage Range (Vdd)	-0.2 to +12V
Bias Voltage Range (Vss)	+0.2 to -12V
Channel Temperature (Tc)	150 °C
Thermal Resistance (channel to ground paddle)	128 °C/W
Storage Temperature	-65 to +150 °C
Operating Temperature	-40 to +85 °C
ESD Sensitivity (HBM)	Class1A Passed 250V

**ELECTROSTATIC SENSITIVE DEVICE
OBSERVE HANDLING PRECAUTIONS**
Truth Table

Control Voltage Input						Phase Shift (Degrees) RFIN - RFOUT
Bit 1	Bit 2	Bit 3	Bit 4	Bit 5	Bit 6	
0	0	0	0	0	0	Reference*
1	0	0	0	0	0	5.625
0	1	0	0	0	0	11.25
0	0	1	0	0	0	22.5
0	0	0	1	0	0	45.0
0	0	0	0	1	0	90.0
0	0	0	0	0	1	180.0
1	1	1	1	1	1	354.375

Any combination of the above states will provide a phase shift approximately equal to the sum of the bits selected.
*Reference corresponds to monotonic setting



GaAs MMIC 6-BIT DIGITAL PHASE SHIFTER, 2.5 - 3.1 GHz

Outline Drawing

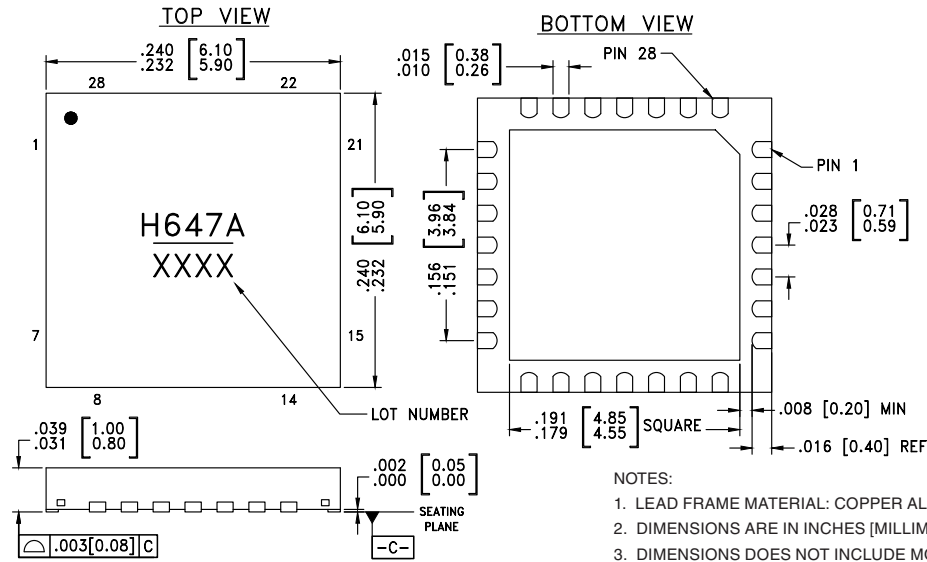

NOTES:

1. LEAD FRAME MATERIAL: COPPER ALLOY
2. DIMENSIONS ARE IN INCHES [MILLIMETERS].
3. DIMENSIONS DOES NOT INCLUDE MOLDFLASH OF 0.15mm PER SIDE
4. DIMENSIONS DOES NOT INCLUDE MOLDFLASH OF 0.25mm PER SIDE
5. ALL GROUND LEADS AND GROUND PADDLE MUST BE SOLDERED TO PCB RF GROUND.
6. CLASSIFIED AS MOISTURE SENSITIVITY LEVEL (MSL) 1.

Package Information

Part Number	Package Body Material	Lead Finish	MSL Rating	Package Marking ^[2]
HMC647ALP6E	RoHS-compliant Low Stress Injection Molded Plastic	100% matte Sn	MSL3 ^[1]	H647A XXXX

[1] Max peak reflow temperature of 260 °C

[2] 4-Digit lot number XXXX

Pin Descriptions

Pin Number	Function	Description	Interface Schematic
1	Vdd	Voltage Supply	
2, 20	GND	These pins and exposed ground paddle must be connected to RF/DC ground.	
3	RFIN	This port is DC coupled and matched to 50 Ohms.	
4 - 18, 21	N/C	No connection required. These pins may be connected to RF/DC ground without affecting performance.	
19	RFOUT	This port is DC coupled and matched to 50 Ohms.	
22 - 24 26 - 28	BIT6, BIT5, BIT4, BIT3, BIT2, BIT1	Control Input. See truth table and control voltage tables.	
25	Vss	Voltage Supply	

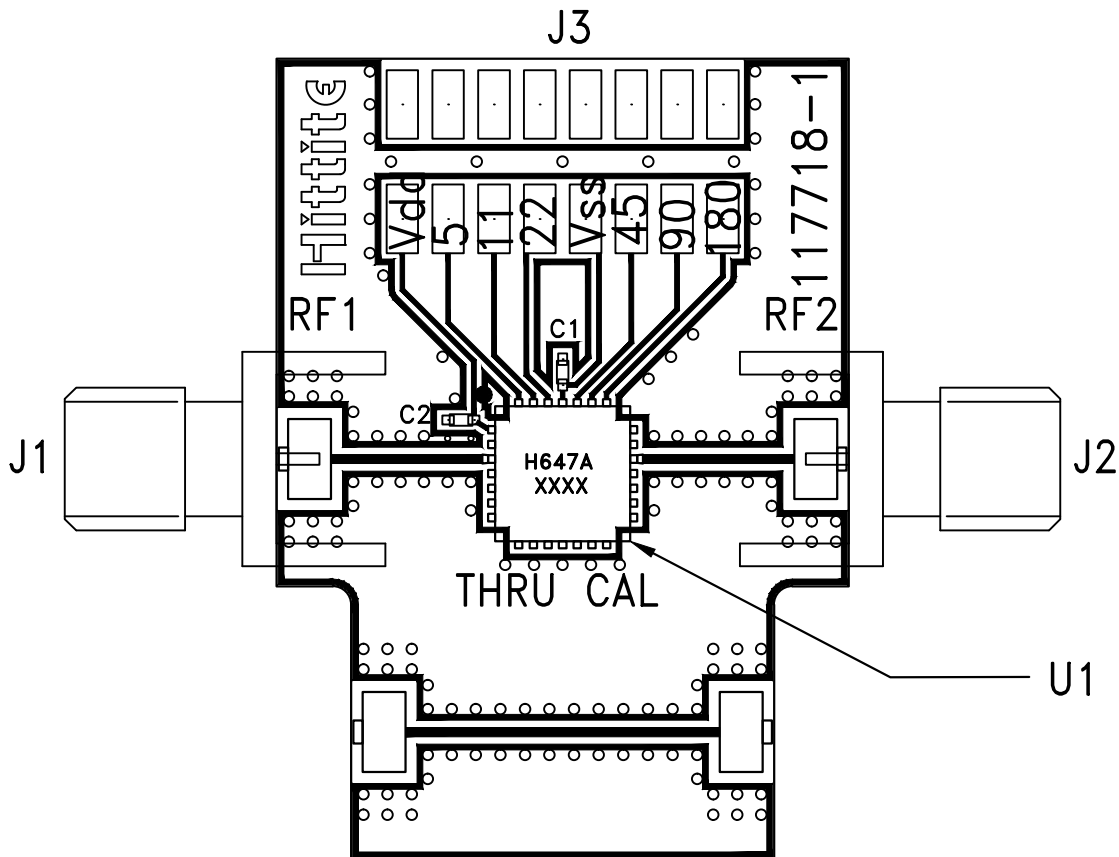
**GaAs MMIC 6-BIT DIGITAL
PHASE SHIFTER, 2.5 - 3.1 GHz**
Evaluation PCB

List of Materials for Evaluation EV1HMC647ALP6 [1][3]

Item	Description
J1 - J2	PCB Mount SMA RF Connector
J3	Header 2mm, 16 pins
C1, C2	1000pF, 0402 pkg
U1	HMC647ALP6E 6-Bit Digital Phase Shifter
PCB [2]	117718 Evaluation PCB

[1] Reference this number when ordering complete evaluation PCB

[2] Circuit Board Material: Rogers 4350

[3] Please refer to part's pin description and functional diagram for pin out assignments on evaluation board.

The circuit board used in the final application should use RF circuit design techniques. Signal lines should have 50 ohm impedance while the package ground leads and exposed paddle should be connected directly to the ground plane similar to that shown. A sufficient number of via holes should be used to connect the top and bottom ground planes. The evaluation board should be mounted to an appropriate heat sink. The evaluation circuit board shown is available from Hittite upon request.