



GL6-P0511S02

G6

PHOTOELECTRIC SENSORS

SICK
Sensor Intelligence.



Illustration may differ



Ordering information

Type	Part no.
GL6-P0511S02	1052633

Other models and accessories → www.sick.com/G6

Detailed technical data

Features

Sensor/ detection principle	Photoelectric retro-reflective sensor
Dimensions (W x H x D)	12 mm x 21 mm
Type of light	Visible red light
Wave length	680 nm

Mechanics/electronics

Supply voltage	12 V DC ... 24 V DC
Ripple	± 10 %
Power consumption	≤ 30 mA ¹⁾
Switching output	PNP
Switching mode	Light switching
Output current I_{max.}	≤ 100 mA ²⁾
Response time	< 625 μs ³⁾
Connection type	Cable with connector M8, 3-pin, 200 mm
Housing material	Plastic, ABS/PC
Optics material	Plastic, PMMA
Enclosure rating	IP67
Ambient operating temperature	-25 °C ... +55 °C
Ambient storage temperature	-40 °C ... +70 °C
UL File No.	NRKH.E348498 & NRKH7.E348498

¹⁾ Without load.

²⁾ At U_v > 24 V, I_A max. = 50 mA.

³⁾ Signal transit time with resistive load.

Classifications

ECI@ss 5.0	27270902
ECI@ss 5.1.4	27270902
ECI@ss 6.0	27270902
ECI@ss 6.2	27270902
ECI@ss 7.0	27270902
ECI@ss 8.0	27270902
ECI@ss 8.1	27270902
ECI@ss 9.0	27270902
ETIM 5.0	EC002717
ETIM 6.0	EC002717
UNSPSC 16.0901	39121528

Adjustments possible

No adjustment possibility

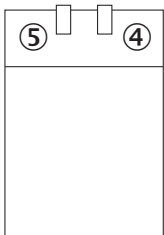

- ④ LED indicator green: Supply voltage active
- ⑤ LED indicator yellow: Status of received light beam

Connection diagram

Cd-045

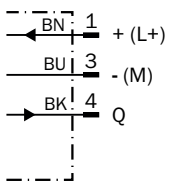

Characteristic curve

GL6G

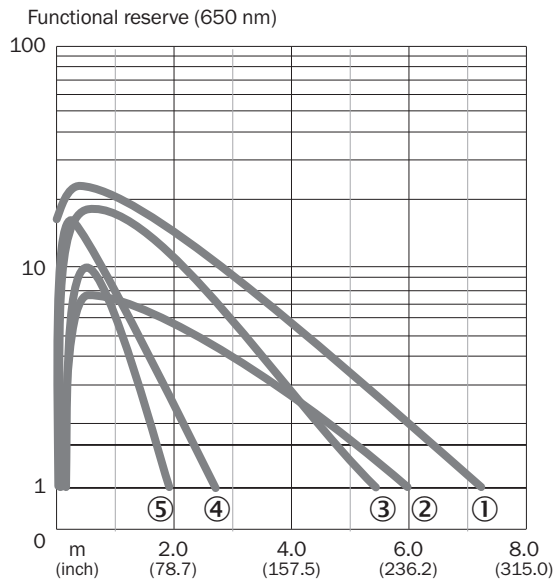

- ① Reflector PL80A
- ② Reflector PL40A
- ③ Reflector P250
- ④ Reflector PL20A
- ⑤ Reflective tape Diamond Grade

Light spot size

GL6, GL6G

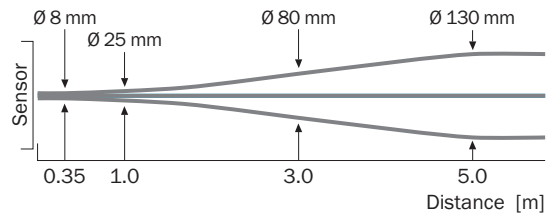

Sensing range diagram

GL6

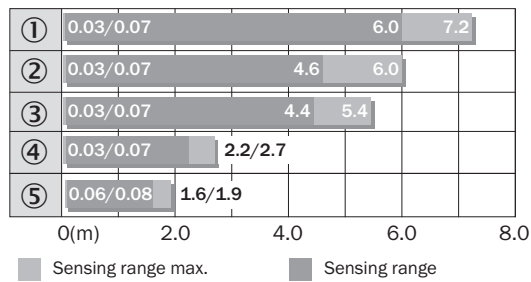

- ① Reflector PL80A
- ② Reflector PL40A
- ③ Reflector P250
- ④ Reflector PL20A
- ⑤ Reflective tape Diamond Grade

Dimensional drawing (Dimensions in mm (inch))

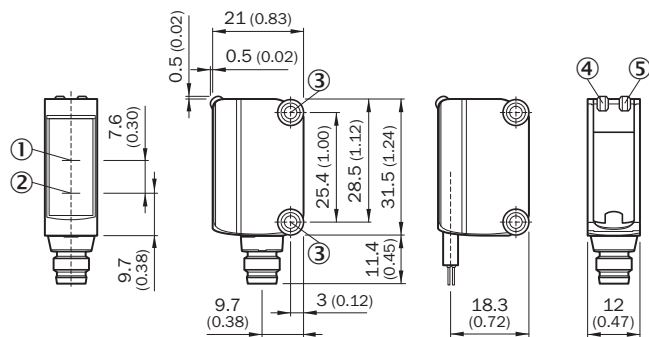











- ① Optical axis, receiver
- ② Optical axis, sender
- ③ Mounting holes M3
- ④ LED indicator green: Supply voltage active
- ⑤ LED indicator yellow: Status of received light beam

Recommended accessories

Other models and accessories → www.sick.com/G6

	Brief description	Type	Part no.
Universal bar clamp systems			
	Clamp bar to fix G6 sensors on rods of 10 mm, clamp-on design up to 4 mm wall thickness, aluminum (clamp bar), stainless steel (bracket), clamp bar for 10 mm rod mounting and clamp function, mounting bracket, mounting hardware	BEF-KHS-ISG6	2075080
Device protection (mechanical)			
	Stainless steel 1.4301 (SVS 304), 3 mm thick protective sleeve for G6, stainless steel 1.4301, mounting hardware included	BEF-SG-G6	2069044

	Brief description	Type	Part no.
Mounting brackets and plates			
		BEF-WN-G6	2062909
Plug connectors and cables			
	Head A: female connector, M8, 3-pin, straight Head B: open cable ends Cable: PVC, unshielded, 2 m	DOL-0803-G02M	6010785
	Head A: female connector, M8, 3-pin, straight Head B: open cable ends Cable: PVC, unshielded, 5 m	DOL-0803-G05M	6022009
	Head A: female connector, M8, 3-pin, angled Head B: open cable ends Cable: PVC, unshielded, 2 m	DOL-0803-W02M	6008489
	Head A: female connector, M8, 3-pin, angled Head B: open cable ends Cable: PVC, unshielded, 5 m	DOL-0803-W05M	6022010
Masks			
	Slit mask, vertical slots, slot width: 1.0 mm, 2 pieces, black, Aluminum, Slit mask (2 pieces)	BEF-SLIT MASK-G6	2075254
Reflectors			
	Rectangular, screw connection, 47 mm x 47 mm, PMMA/ABS, Screw-on, 2 hole mounting	P250	5304812
	Rectangular, screw connection, 56 mm x 28 mm, PMMA/ABS, Screw-on, 2 hole mounting	PL30A	1002314
	Rectangular, screw connection, 80 mm x 80 mm, PMMA/ABS, Screw-on, 2 hole mounting	PL80A	1003865
	Fine triple reflector, screw connection, suitable for laser sensors, 18 mm x 18 mm, PMMA/ABS, Screw-on, 2 hole mounting	PL10F	5311210
	Self-adhesive	REF-IRF-56	5314244
	Round, plugable for metal plates, PMMA/ABS, Plug-in for sheets	PL22-3	1004488

SICK AT A GLANCE

SICK is one of the leading manufacturers of intelligent sensors and sensor solutions for industrial applications. A unique range of products and services creates the perfect basis for controlling processes securely and efficiently, protecting individuals from accidents and preventing damage to the environment.

We have extensive experience in a wide range of industries and understand their processes and requirements. With intelligent sensors, we can deliver exactly what our customers need. In application centers in Europe, Asia and North America, system solutions are tested and optimized in accordance with customer specifications. All this makes us a reliable supplier and development partner.

Comprehensive services complete our offering: SICK LifeTime Services provide support throughout the machine life cycle and ensure safety and productivity.

For us, that is “Sensor Intelligence.”

WORLDWIDE PRESENCE:

Contacts and other locations –www.sick.com