



**BREAKDOWN VOLTAGE: 62 --- 270 V**  
**POWER DISSIPATION: 1.7 W**

## Features

- ◇ Bidirectional crowbar protection
- ◇ Voltage range: from 62V to 270V.
- ◇ Holding current:  $I_H = 150\text{mA min}$
- ◇ Repetitive peak pulse current:  $I_{PP} = 50\text{A}, 10/1000 \mu\text{s}$ .

## DESCRIPTION

The TPA series are designed for protecting sensitive telecommunication equipment against lightning and transient voltages induced by AC power lines.

The devices provide bidirectional protection by crowbar action. Their characteristic response to transient over-voltages makes them particularly suited to protect sensitive telecommunication equipment.

### DO-15

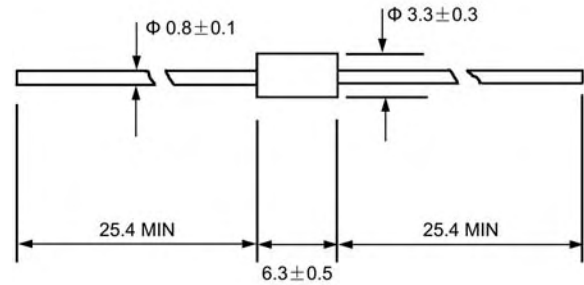

Dimensions in millimeters

## SCHEMATIC DIAGRAM

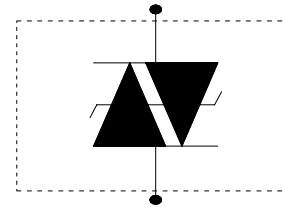

Complies with the following standards:	Peak surge voltage (V)	Voltage waveform ( $\mu\text{s}$ )	Current waveform ( $\mu\text{s}$ )	Admissible $I_{pp}$ (A)	Necessary resistor ( $\Omega$ )
(CCITT)ITU-K20	1000	10/700	5/310	25	--
(CCITT)ITU-K17	1500	10/700	5/310	38	--
VDE0433	2000	10/700	5/310	50	--
VDE0878	2000	1.2/50	1/20	50	--
IEC-1000-4-5	level 3 level 4	10/700 1.2/50	5/310 8/20	50 100	-- --
FCC Part 68, lightning surge type A	1500 800	10/160 10/560	10/160 10/560	75 55	12.5 6.5
FCC Part 68, lightning surge type B	1000	9/720	5/320	25	--
BELLCORE TR-NWT-001089 First level	2500 1000	2/10 10/1000	2/10 10/1000	150 50	11.5 10
BELLCORE TR-NWT-001089 Second level	5000	2/10	1/20	150	11.5
CNET131-24	1000	0.5/700	0.8/310	25	--

**ABSOLUTE MAXIMUM RATINGS (T<sub>A</sub>=25°C)**

Symbol	Parameter		Value	Unit
P	Power dissipation on infinite heatsink	T <sub>amb</sub> =50°C	1.7	W
I <sub>pp</sub>	Peak pulse current	10/1000 μ s 8/20 μ s	50 100	A
I <sub>FSM</sub>	Non repetitive surge peak on-state current	tp=20ms	30	A
I <sup>2</sup> t	I <sup>2</sup> t value for fusing	tp=20ms	9	A <sup>2</sup> s
dV/dt	Critical rate of rise of off-state voltage	V <sub>RM</sub>	5	KV/μ s
T <sub>stg</sub>	Storage temperature range		-55to+150	°C
T <sub>j</sub>	Maximum junction temperature		150	°C
T <sub>L</sub>	Maximum leadtemperature for soldering during 10sat 5mmform case		230	°C

**THERMAL RESISTANCES**

Symbol	Parameter	Value	Unit
R <sub>th(j-l)</sub>	Junction to leads (L <sub>lead</sub> =10mm)	60	°C/W
R <sub>th(j-a)</sub>	Junction to ambient on printed circuit (L <sub>lead</sub> =10mm)	100	°C/W

Type	I <sub>RM</sub> @ V <sub>RM</sub>		V <sub>BR</sub> @ I <sub>R</sub>		V <sub>BO</sub> @ I <sub>BO</sub>		I <sub>H</sub> min. note2 mA	C max. note3 pF
	μA	V	V	mA	V	mA		
TPA62	2	56	62	1.0	82	800	150	150
TPA68	2	61	68	1.0	90	800	150	150
TPA100	2	90	100	1.0	133	800	150	100
TPA120	2	108	120	1.0	160	800	150	100
TPA130	2	117	130	1.0	173	800	150	100
TPA180	2	162	180	1.0	240	800	150	100
TPA200	2	180	200	1.0	267	800	150	100
TPA220	2	198	220	1.0	293	800	150	100
TPA240	2	216	240	1.0	320	800	150	100
TPA270	2	243	270	1.0	360	800	150	100

**ELECTRICAL CHARACTERISTICS (T<sub>A</sub>=25°C)**

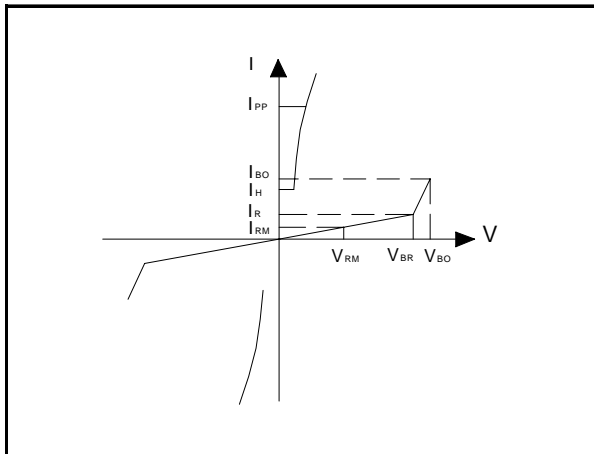

Symbol	Parameter
V <sub>RM</sub>	Stand-off voltage
I <sub>RM</sub>	Leakage current at stand-off voltage
V <sub>R</sub>	Continuous reverse voltage
V <sub>BR</sub>	Breakdown voltage
V <sub>BO</sub>	Breakover voltage
I <sub>H</sub>	Holding current
I <sub>BO</sub>	Breakover current
I <sub>PP</sub>	Peak pulse current
C	Capacitance

Note2: See test circuit2.

Note1: Measured at 50Hz (1 cycle) See test circuit 1.  
Note3: V<sub>R</sub>=1V, F=1MHz, Refer to fig.3 for C versus V<sub>R</sub>.

Download from [alldatasheet.com](http://alldatasheet.com)

<http://www.lgesemi.com>

## Ratings AND Characteristic Curves

### TEST CIRCUIT 1 FOR IBO AND VBO PARAMETERS:

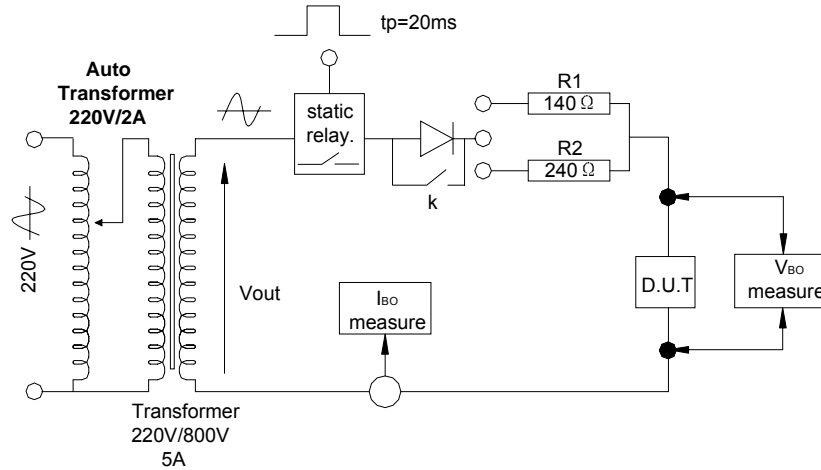

### TEST PROCEDURE :

Pulse Test duration ( $t_p = 20\text{ms}$ ):

- For Bidirectional devices = Switch K is closed
- For Unidirectional devices = Switch K is open.

$V_{OUT}$  Selection

- Device with  $V_{BO} < 200$  Volt
  - $V_{OUT} = 250 V_{RMS}$ ,  $R1 = 140 \Omega$ .
- Device with  $V_{BO} \geq 200$  Volt
  - $V_{OUT} = 480 V_{RMS}$ ,  $R2 = 240\Omega$ .

### TEST CIRCUIT 2 FOR IH PARAMETER:

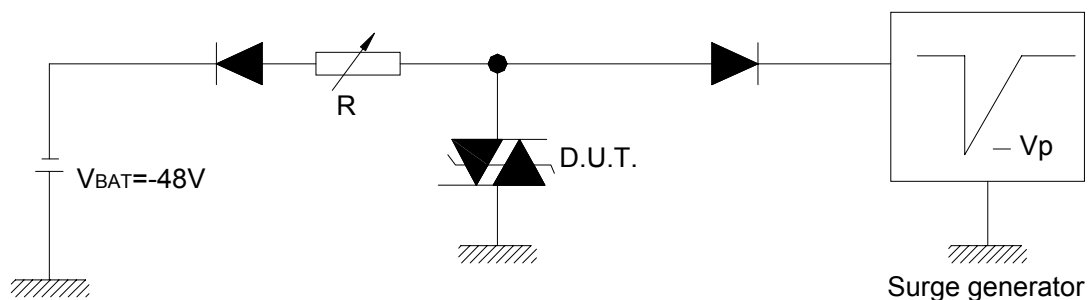

This is a GO-NOGOTest which allows to confirm the holding current ( $I_H$ ) level in a functional test circuit.

### TEST PROCEDURE :

- 1) Adjust the current level at the  $I_H$  value by short circuiting the AK of the D.U.T.
- 2) Fire the D.U.T with a surge current :  $I_{pp} = 10A$  ,  $10/1000$  ms.
- 3) The D.U.T will come back off-state within 50ms max.

## Ratings AND Characteristic Curves

**FIG.1 – NON REPETITIVE SURGE PEAK ON-STATE CURRENT VERSUS OVERLOAD DURATION**  
 ( $T_J$  IN  $|t|$  = 25°C).

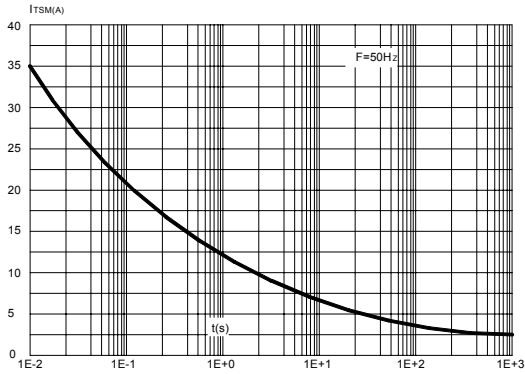

**FIG.2 – RELATIVE VARIATION OF GOIDING CURRENT VERSUS JUNCTION TEMPERATURE.**

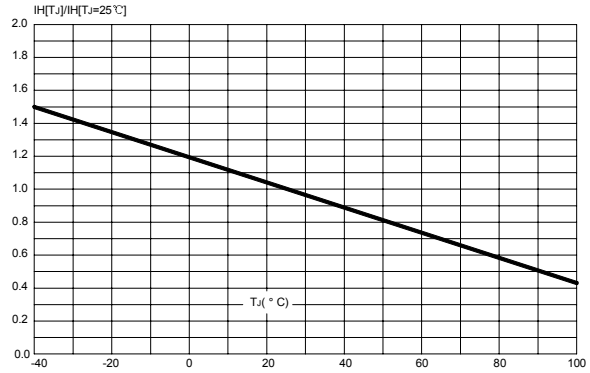

**FIG.3 – RELATIVE VARIATION OF JUNCTION CAPACITANCE VERSUS REVERSE APPLIED VOLTAGE**

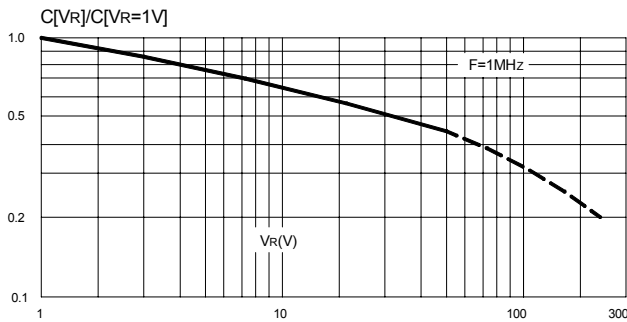

**FIG.4 – ON-STATE CURRENT VERSUS ON-STATE VOLTAGE**

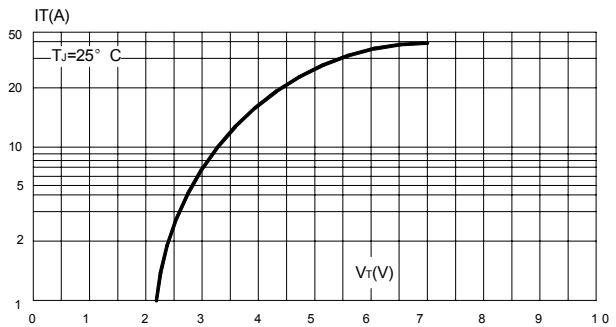

**FIG.5 – TRANSIENT THERMAL IMPEDANCE JUNCTION TO AMBIENT VERSUS PULSE DURATION**

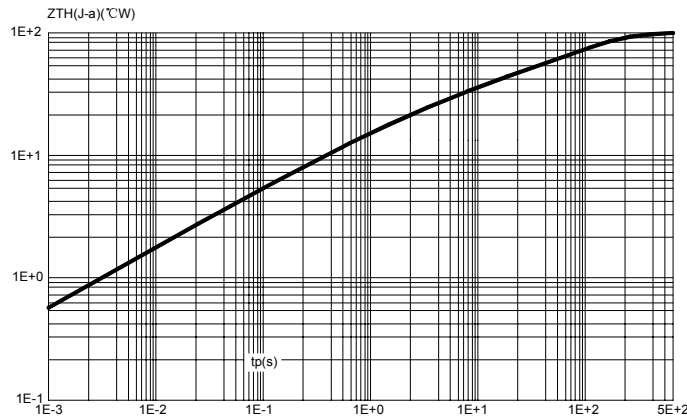

PACKAGE	SPQ/PCS	CARTON SPQ/PCS	CARTON SIZE/CM	CARTON GW/KG	CARTON NW/KG
DO-15	3000/AMMO	30000	42X28X31	12.00	10.00