



Features

- Drain-Source Breakdown Voltage V_{DSS} - 50 V
- Drain-Source On-Resistance
 $R_{DS(ON)}$ 5 Ω , at $V_{GS} = -5.0V$, $I_{DS} = -100mA$
- Continuous Drain Current at $T_A=25^\circ C$ $I_D = -130mA$
- Advanced high cell density Trench Technology
- RoHS Compliance & Halogen Free

Description

The CTLM13PS05-R3 uses high performance Trench Technology to provide excellent $R_{DS(ON)}$ and low gate charge which is suitable for most of the synchronous buck converter applications .

Applications

- Power Management
- Portable Equipment
- Battery Powered System
- DC/DC Converter
- Load Switch

Package Outline

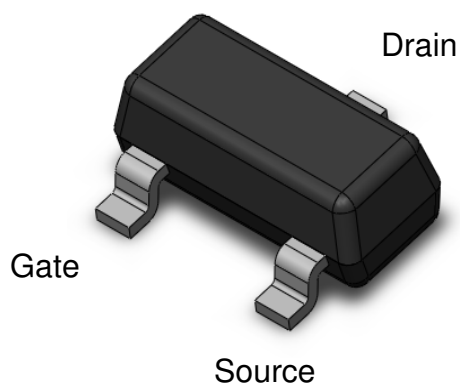

Schematic

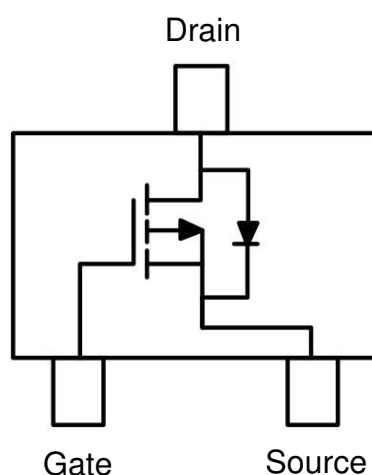

**Absolute Maximum Rating at 25°C**

Symbol	Parameters	Ratings	Units	Notes
V_{DS}	Drain-Source Voltage	-50	V	
V_{GS}	Gate-Source Voltage	± 20	V	
I_D	Continuous Drain Current @ $T_A=25^\circ\text{C}$	-0.13	A	1
I_{DM}	Pulsed Drain Current	-0.52	A	1
P_D	Total Power Dissipation @ $T_A=25^\circ\text{C}$	0.225	W	2
T_{STG}	Storage Temperature Range	-55 to 150	$^\circ\text{C}$	
T_J	Operating Junction Temperature Range	-55 to 150	$^\circ\text{C}$	

Thermal Characteristics

Symbol	Parameters	Test Conditions	Min	Typ	Max	Units	Notes
$R_{\theta JA}$	Thermal Resistance Junction-Ambient (t=10s)		-	555	-	$^\circ\text{C}/\text{W}$	1,4

**Electrical Characteristics** $T_A = 25^\circ\text{C}$ (unless otherwise specified)**Static Characteristics**

Symbol	Parameters	Test Conditions	Min	Typ	Max	Units	Notes
$B_{V_{DS}}$	Drain-Source Breakdown Voltage	$V_{GS}=0V, I_D = -250\mu A$	-50	-	-	V	
I_{DSS}	Drain-Source Leakage Current	$V_{DS} = -50V, V_{GS} = 0V$	-	-	-1	μA	
I_{GSS}	Gate-Source Leakage Current	$V_{GS} = \pm 20V, V_{DS} = 0V$	-	-	± 100	nA	

On Characteristics

Symbol	Parameters	Test Conditions	Min	Typ	Max	Units	Notes
$R_{DS(ON)}$	Drain-Source On-Resistance	$V_{GS} = -5V, I_D = -100mA$	-	5	10		Fig 4
$V_{GS(TH)}$	Gate-Source Threshold Voltage	$V_{GS} = V_{DS}, I_D = -250\mu A$	-0.8	-	-2.0	V	Fig 5

Dynamic Characteristics

Symbol	Parameters	Test Conditions	Min	Typ	Max	Units	Notes
C_{ISS}	Input Capacitance	$V_{DS} = -5V,$ $V_{GS} = 0V,$ $f=1MHz$	-	30	-	pF	Fig 3
C_{OSS}	Output Capacitance		-	10	-		
C_{RSS}	Reverse Transfer Capacitance		-	5	-		

Switching Characteristics

Symbol	Parameters	Test Conditions	Min	Typ	Max	Units	Notes
$T_{D(ON)}$	Turn-On Delay Time	$V_{DS} = -15V, R_L = 50\Omega$ $I_D = -2.5A$	-	2.5	-	ns	Fig 11 & 12
T_R	Rise Time		-	1.0	-		
$T_{D(OFF)}$	Turn-Off Delay Time		-	16	-		
T_F	Fall Time		-	8	-		



CTLM13PS05-R3

P-Channel Enhancement MOSFET

Drain-Source Diode Characteristics

Symbol	Parameters	Test Conditions	Min	Typ	Max	Units	Notes
V _{SD}	Body Diode Forward Voltage	V _{GS} = 0V, I _D = -0.1A	-	-2.5	-	V	
I _{SD}	Body Diode Continuous Current		-	-	-0.13	A	1

Note:

1. The power dissipation is limited by 150°C junction temperature.
2. Device mounted on a glass-epoxy board

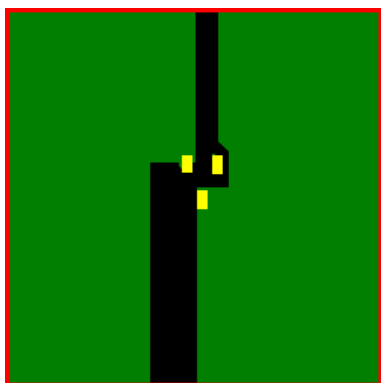

FR-4
25.4 × 25.4 mm .
2 Oz Copper

Actual Size

3. The data tested by pulsed , pulse width $\leq 300\mu\text{s}$, duty cycle $\leq 2\%$
4. Thermal Resistance follow JESD51-3.



Typical Characteristic Curves

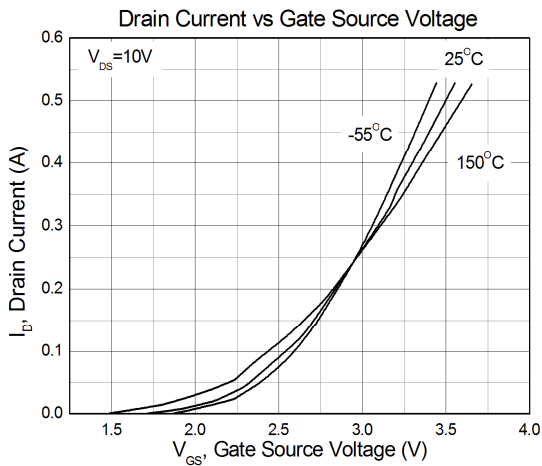

Figure 1

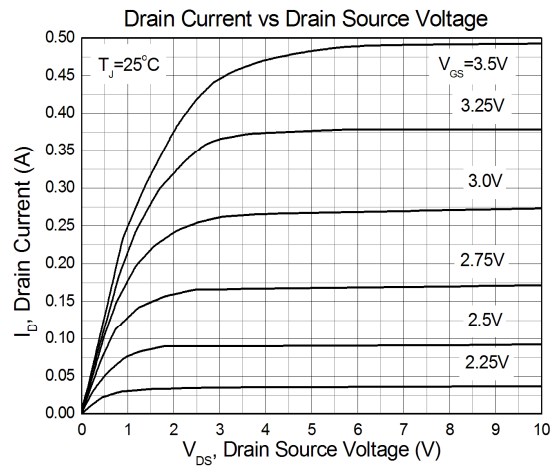

Figure 2

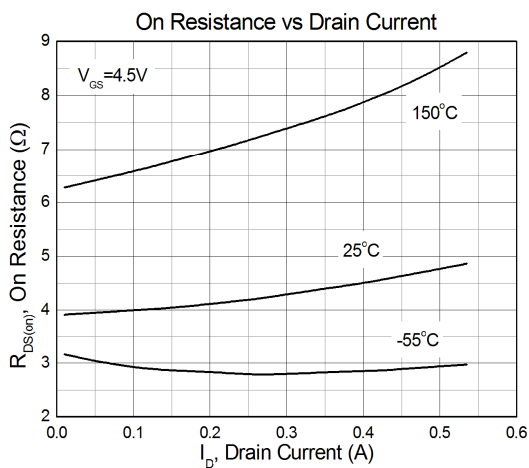

Figure 3

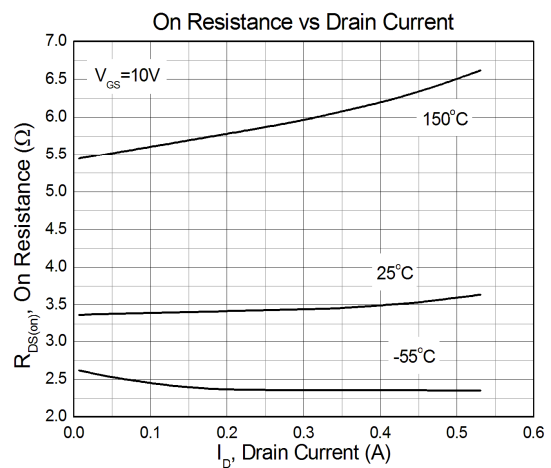

Figure 4

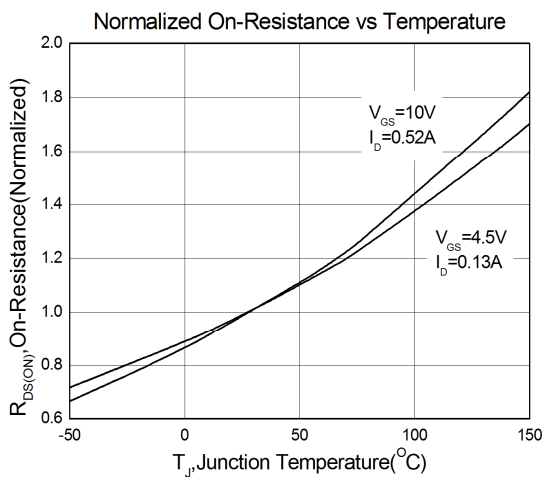

Figure 5

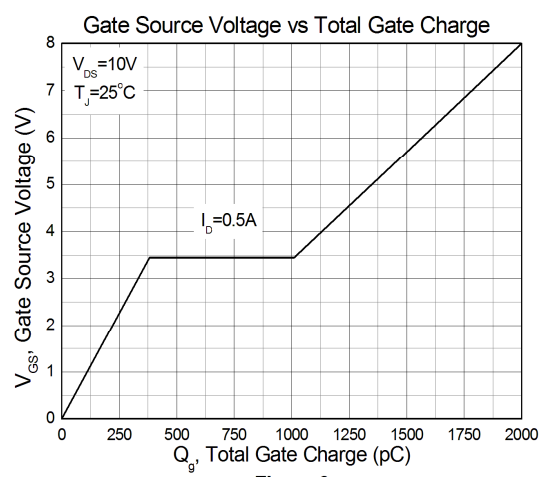
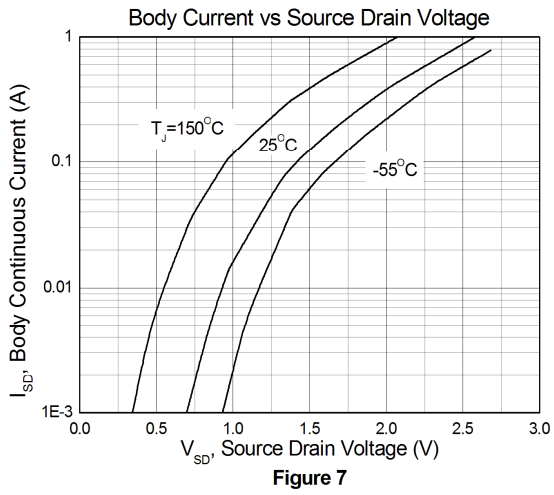

Figure 6



CTL13PS05-R3

P-Channel Enhancement MOSFET





Test Circuits & Waveforms

Figure 8: Gate Charge Test Circuit

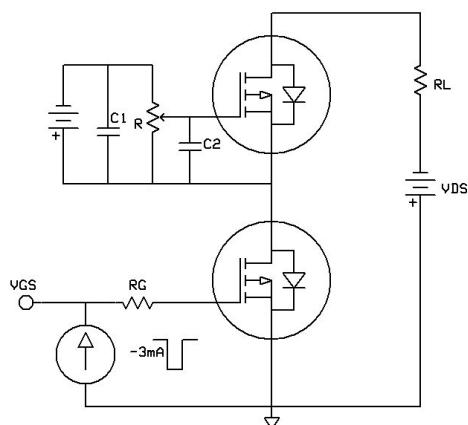

Figure 9: Gate Charge Waveform

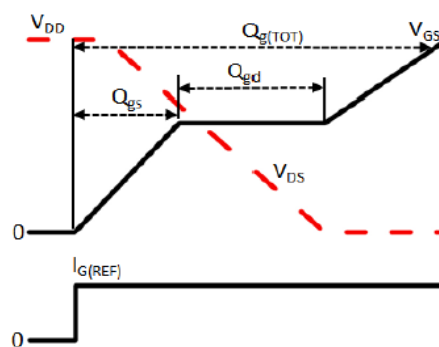

Figure 10: Switching Time Test Circuit

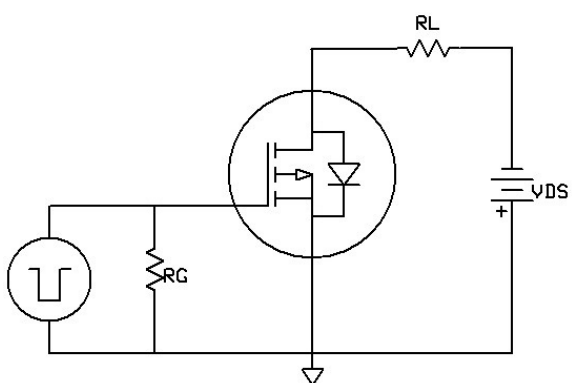
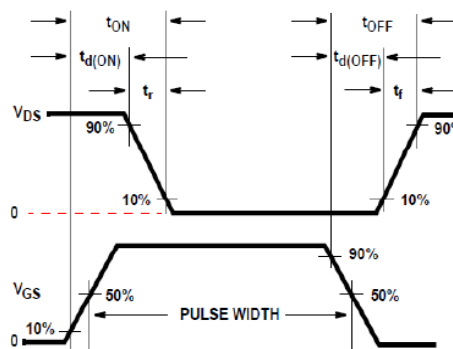
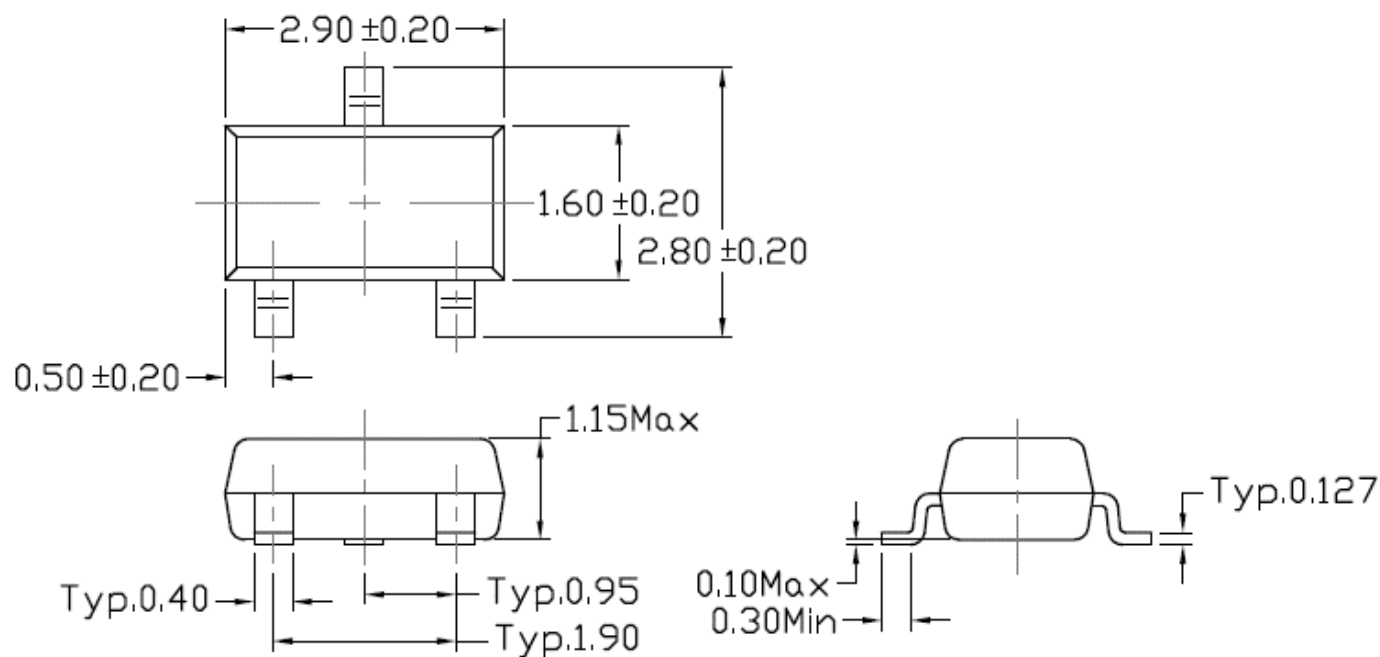

Figure 11: Switching Time Waveform





Package Dimension (SC-59)



Recommended pad layout for surface mount leadform

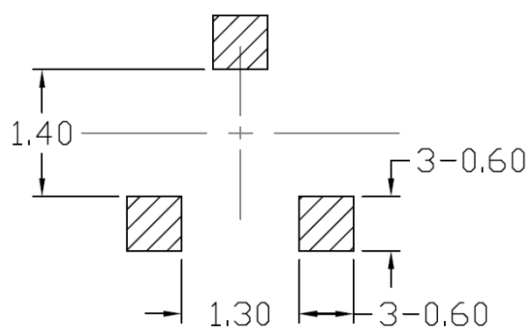



CTLM13PS05-R3

P-Channel Enhancement MOSFET

Marking Information

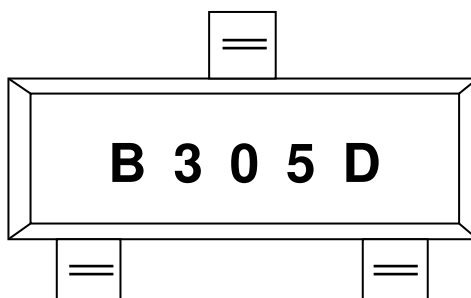

B305D : Device Number

Ordering Information

<i>Part Number</i>	<i>Description</i>	<i>Quantity</i>
CTLM13PS05-R3	SC-59 Reel	3000 pcs



Reflow Profile

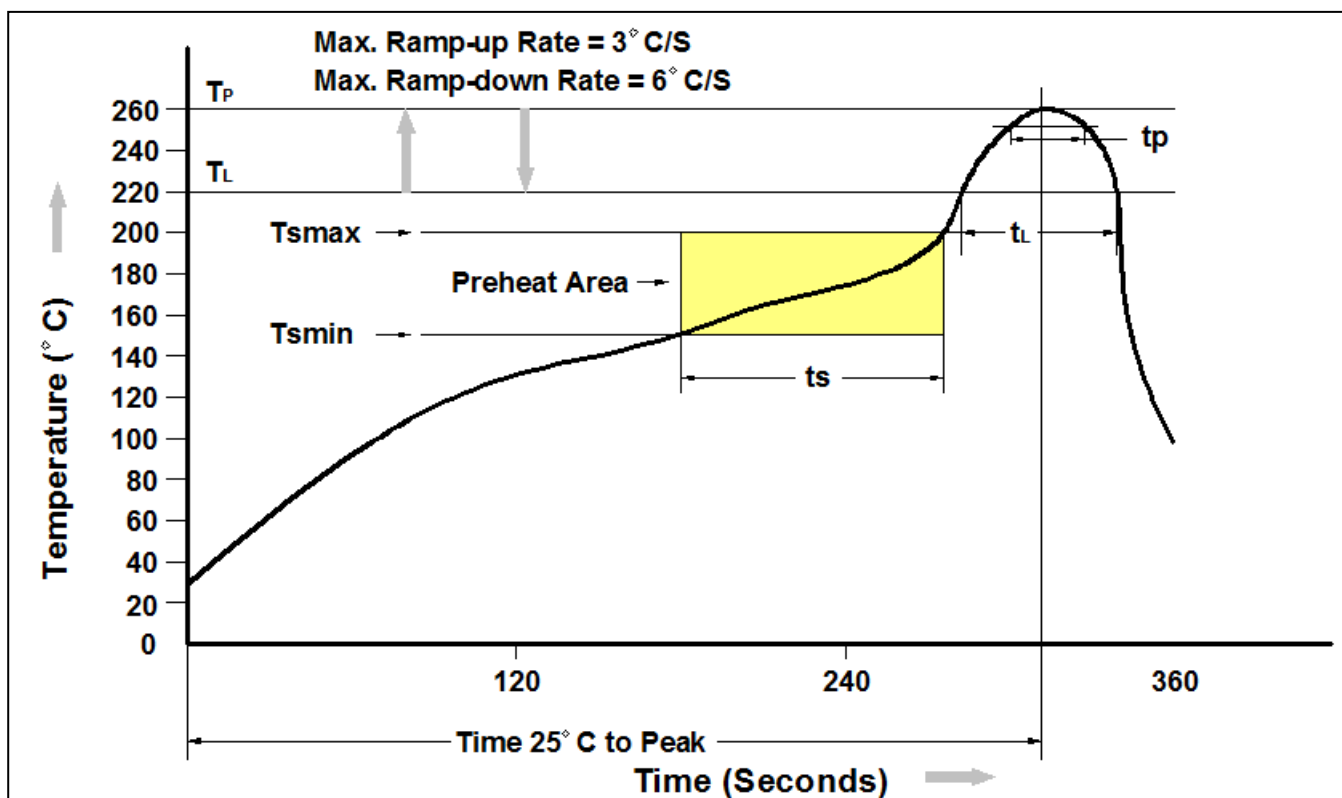

Profile Feature	Pb-Free Assembly Profile
Temperature Min. (T _{min})	150 °C
Temperature Max. (T _{max})	200 °C
Time (t _s) from (T _{min} to T _{max})	60-120 seconds
Ramp-up Rate (t _L to t _P)	3 °C/second max.
Liquidous Temperature (T _L)	217 °C
Time (t _L) Maintained Above (T _L)	60 – 150 seconds
Peak Body Package Temperature	260 °C +0 °C / -5 °C
Time (t _P) within 5 °C of 260 °C	30 seconds
Ramp-down Rate (T _P to T _L)	6 °C/second max
Time 25 °C to Peak Temperature	8 minutes max.



DISCLAIMER

CT MICRO RESERVES THE RIGHT TO MAKE CHANGES WITHOUT FURTHER NOTICE TO ANY PRODUCTS HEREIN TO IMPROVE RELIABILITY, FUNCTION OR DESIGN. CT MICRO DOES NOT ASSUME ANY LIABILITY ARISING OUT OF THE APPLICATION OR USE OF ANY PRODUCT OR CIRCUIT DESCRIBED HEREIN; NEITHER DOES IT CONVEY ANY LICENSE UNDER ITS PATENT RIGHTS, NOR THE RIGHTS OF OTHERS.

CT MICRO ARE NOT AUTHORIZED FOR USE AS CRITICAL COMPONENTS IN LIFE SUPPORT DEVICES OR SYSTEMS WITHOUT EXPRESS WRITTEN APPROVAL OF CT MICRO INTERNATIONAL CORPORATION..

- 1. Life support devices or systems are devices or systems which, (a) are intended for surgical implant into the body, or (b) support or sustain life, or (c) whose failure to perform when properly used in accordance with instruction for use provided in the labeling, can be reasonably expected to result in significant injury to the user.*
- 2. A critical component is any component of a life support device or system whose failure to perform can be reasonably expected to cause the failure of the life support device or system, or to affect its safety or effectiveness.*