

**VI TELEFILTER**

**Filter specification**

**TFS 274**

**1/5**

**Measurement condition**

|                          |                  |     |
|--------------------------|------------------|-----|
| Ambient temperature:     | 23               | °C  |
| Input power level:       | 5                | dBm |
| Terminating impedance: * |                  |     |
| Input:                   | 360 Ω    -6,6 pF |     |
| Output:                  | 360 Ω    -6,3 pF |     |

**Characteristics**

**Remark:**

The reference level for the relative attenuation  $a_{rel}$  of the TFS 274 is the maximum attenuation in the pass band. The maximum attenuation in the pass band is defined as the insertion loss  $a_e$ . The nominal frequency  $f_N$  is fixed at 274,612 MHz without any tolerance or limit. The values of relative attenuation  $a_{rel}$  are guaranteed for the whole operating temperature range. The frequency shift of the filter in the operating temperature range is included in the production tolerance scheme.

| <b>D a t a</b>                              |                  | <b>typ. value</b> | <b>tolerance / limit</b> |
|---|------------------|-------------------|--------------------------|
| <b>Insertion loss</b><br>(reference level)  | $a_e$            | 3,1 dB            | max. 4,0 dB              |
| <b>Nominal frequency</b>                    | $f_N$            | -                 | 274,612 MHz              |
| <b>Passband</b>                             |                  | -                 | $f_N \pm 388$ kHz        |
| <b>Pass band ripple</b>                     |                  | 0,3 dB            | max. 1 dB                |
| <b>Relative attenuation</b>                 | $a_{rel}$        |                   |                          |
| $f_N - 0,388$ MHz ... $f_N + 0,388$ MHz     |                  | 0,3 dB            | max. 1 dB                |
| $f_N - 64,600$ MHz ... $f_N - 12,612$ MHz   |                  | 55 dB             | min. 40 dB               |
| $f_N - 12,612$ MHz ... $f_N - 8,612$ MHz    |                  | 54 dB             | min. 50 dB               |
| $f_N - 8,612$ MHz ... $f_N - 4,500$ MHz     |                  | 47 dB             | min. 40 dB               |
| $f_N + 4,500$ MHz ... $f_N + 55,400$ MHz    |                  | 46 dB             | min. 40 dB               |
| <b>Group delay</b>                          | mean value in PB | 380 ns            | max. 0,5 μs              |
| <b>Group delay ripple within PB</b>         |                  | 60 ns             | max. 150 ns              |
| <b>Return loss within PB</b>                |                  | 16 dB             | min. 10 dB               |
| <b>Input power level</b>                    |                  | -                 | max. 15 dBm              |
| <b>Operating temperature range</b>          | OTR              | -                 | - 20 °C ... + 85 °C      |
| <b>Storage temperature range</b>            |                  | -                 | - 40 °C ... + 90 °C      |
| <b>Temperature coefficient of frequency</b> | $TC_f$ **        | -20 ppm/K         | -                        |

\*) The terminating impedances depend on parasitics and q-values of matching elements and the board used, and are to be understood as reference values only. Should there be additional questions do not hesitate to ask for an application note or contact our design team.

\*\*\*)  $\Delta f_c(\text{Hz}) = TC_f(\text{ppm/K}) \times (T - T_0) \times f_{CAT}(\text{MHz})$ .

**Generated:**

---

**Checked / Approved:**

---

**Tele Filter GmbH**  
**Potsdamer Straße 18**  
**D 14 513 TELTOW / Germany**  
**Tel: (+49) 3328 4784-0 / Fax: (+49) 3328 4784-30**  
**E-Mail: [tft@telefilter.com](mailto:tft@telefilter.com)**

VI TELEFILTER reserves the right to make changes to the product(s) and/or information contained herein without notice. No liability is assumed as a result of their use or application. No rights under any patent accompany the sale of any such product(s) or information.

**Filter characteristic**

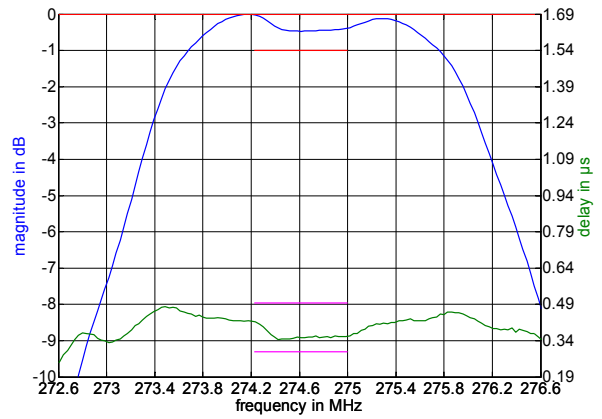
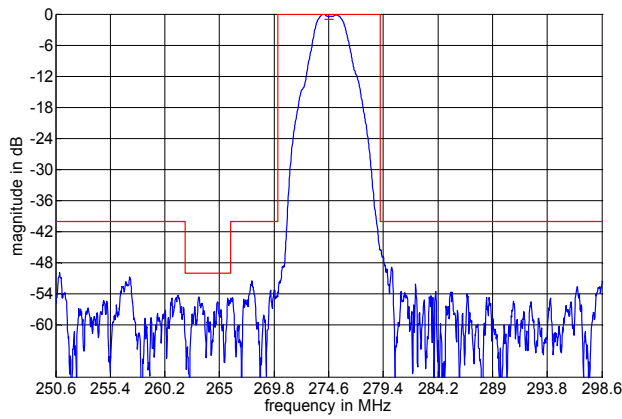

**Construction and pin connection**

(All dimensions in mm)

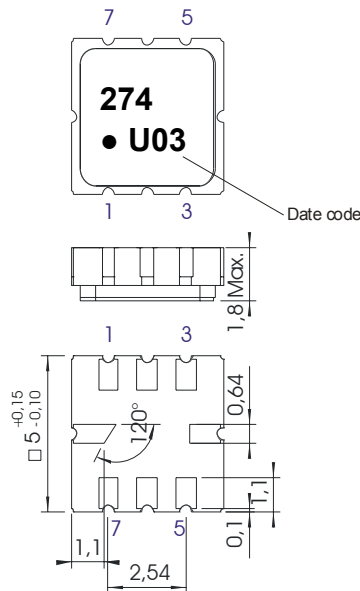

- 1 Input
- 2 Input RF Return
- 3 Ground
- 4 Ground
- 5 Output
- 6 Output RF Return
- 7 Ground
- 8 Ground

Date code: Year + week  
 U 2006  
 V 2007  
 W 2008  
 ...

**50 Ω Test circuit**

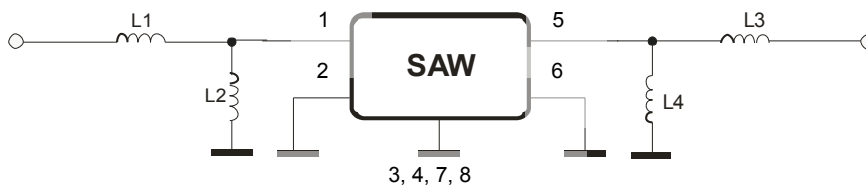

**Tele Filter GmbH**  
 Potsdamer Straße 18  
 D 14 513 TELTOW / Germany  
 Tel: (+49) 3328 4784-0 / Fax: (+49) 3328 4784-30  
 E-Mail: [tft@telefilter.com](mailto:tft@telefilter.com)

VI TELEFILTER reserves the right to make changes to the product(s) and/or information contained herein without notice. No liability is assumed as a result of their use or application. No rights under any patent accompany the sale of any such product(s) or information.

**Stability characteristics, reliability**

After the following tests the filter shall meet the whole specification:

1. Shock: 500g, 1 ms, half sine wave, 3 shocks each plane;  
DIN IEC 68 T2 - 27
2. Vibration: 10 Hz to 500 Hz, 0,35 mm or 5 g respectively, 1 octave per min, 10 cycles per plan, 3 plans;  
DIN IEC 68 T2 - 6
3. Change of temperature: -55 °C to 125°C / 30 min. each / 10 cycles  
DIN IEC 68 part 2 – 14 Test N
4. Resistance to solder heat (reflow): reflow possible: twice max.;  
for temperature conditions refer to the attached "Air reflow temperature conditions" on page 4;

This filter is RoHS compliant (2002/95/EG, 2005/618/EG)

**Packing**

Tape & Reel: IEC 286 – 3, with exeption of value for N and minimum bending radius;  
tape type II, embossed carrier tape with top cover tape on the upper side;

|   |             |
|---|-------------|
| max. pieces of filters per reel:                    | 3000        |
| reel of empty components at start:                  | min. 300 mm |
| reel of empty components at start including leader: | min. 500 mm |
| trailer:  | min. 300 mm |

**Tape (all dimensions in mm)**

- W : 12,00 ± 0,3
- Po : 4,00 ± 0,1
- Do : 1,50 +0,1/-0
- E : 1,75 ± 0,1
- F : 5,50 ± 0,05
- G(min) : 0,75
- P2 : 2,00 ± 0,05
- P1 : 8,00 ± 0,1
- D1(min) : 1,50
- Ao : 5,30 ± 0,1
- Bo : 5,30 ± 0,1
- Ct : 9,5 ± 0,1

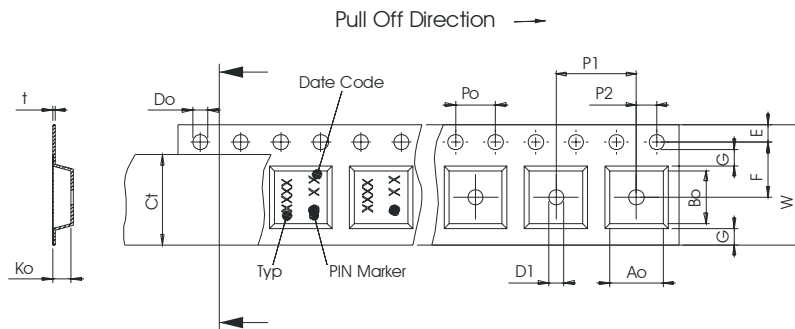

**Reel (all dimensions in mm)**

- A : 330
- W1 : 12,4 +2/-0
- W2(max) : 18,4
- N(min) : 50
- C : 13,0 +0,5/-0,2

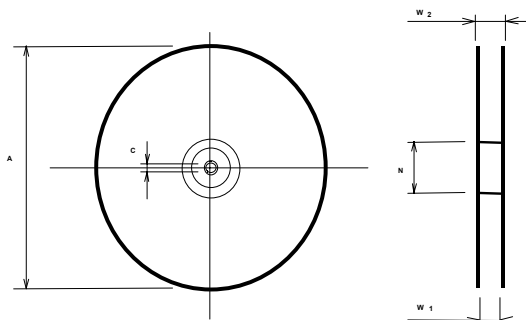

The minimum bending radius is 45 mm.

**Tele Filter GmbH**  
**Potsdamer Straße 18**  
**D 14 513 TELTOW / Germany**  
**Tel: (+49) 3328 4784-0 / Fax: (+49) 3328 4784-30**  
**E-Mail: [tft@telefilter.com](mailto:tft@telefilter.com)**

VI TELEFILTER reserves the right to make changes to the product(s) and/or information contained herein without notice. No liability is assumed as a result of their use or application. No rights under any patent accompany the sale of any such product(s) or information.

**Air reflow temperature conditions**

| Conditions                                 | Exposure                    |
|--|-----------------------------|
| Average ramp-up rate (30°C to 217°C)       | less than 3°C/second        |
| > 100°C                                    | between 300 and 600 seconds |
| > 150°C                                    | between 240 and 500 seconds |
| > 217°C                                    | between 30 and 150 seconds  |
| Peak temperature                           | max. 260°C                  |
| Time within 5°C of actual peak temperature | between 10 and 30 seconds   |
| Cool-down rate (Peak to 50°C)              | less than 6°C/second        |
| Time from 30°C to Peak temperature         | no greater than 300 seconds |

**Chip-mount air reflow profile**

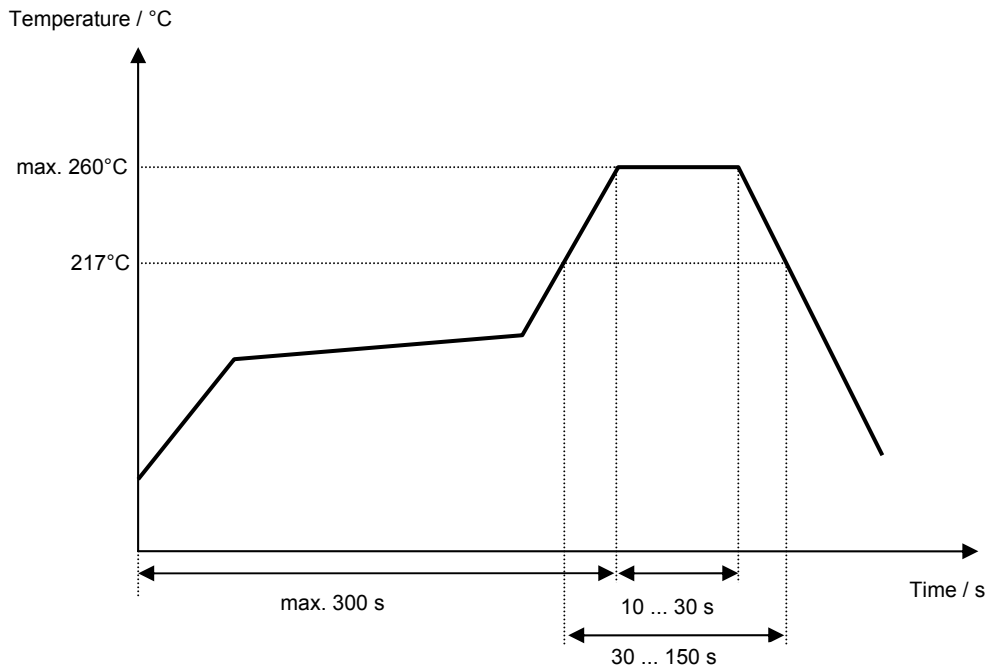

Tele Filter GmbH  
 Potsdamer Straße 18  
 D 14 513 TELTOW / Germany  
 Tel: (+49) 3328 4784-0 / Fax: (+49) 3328 4784-30  
 E-Mail: [tft@telefilter.com](mailto:tft@telefilter.com)

VI TELEFILTER reserves the right to make changes to the product(s) and/or information contained herein without notice. No liability is assumed as a result of their use or application. No rights under any patent accompany the sale of any such product(s) or information.

**VI TELEFILTER****Filter specification****TFS 274****5/5****History**

| <b>Version</b> | <b>Reason of Changes</b>  | <b>Name</b> | <b>Date</b> |
|----------------|---|-------------|-------------|
| 1.0            | Generation of development specification   | Strehl      | 12.08.2004  |
| 1.1            | adjust specification according to new customer requirements   | Steiner     | 17.12.2004  |
| 1.2            | - terminating impedance, typical values and filter characteristic added<br>- matching configuration changed | Pfeiffer    | 18.04.2005  |
| 1.3            | - stability characteristics modified<br>- packing corrected   | Pfeiffer    | 18.01.2006  |

---

**Tele Filter GmbH**  
**Potsdamer Straße 18**  
**D 14 513 TELTOW / Germany**  
**Tel: (+49) 3328 4784-0 / Fax: (+49) 3328 4784-30**  
**E-Mail: [tft@telefilter.com](mailto:tft@telefilter.com)**

VI TELEFILTER reserves the right to make changes to the product(s) and/or information contained herein without notice. No liability is assumed as a result of their use or application. No rights under any patent accompany the sale of any such product(s) or information.