

## FEATURES

**8-channel, 24-bit simultaneous sampling analog-to-digital converter (ADC)**

**Single-ended or true differential inputs**

**Programmable gain amplifier (PGA) per channel (gains of 1, 2, 4, and 8)**

**Low dc input current**

**±4 nA (differential) and ±8 nA (single-ended)**

**Up to 32 kSPS output data rate (ODR) per channel**

**Programmable ODRs and bandwidth**

**Sample rate converter (SRC) for coherent sampling**

**Sampling rate resolution up to  $15.2 \times 10^{-6}$  SPS**

**Low latency sinc3 filter path**

**Adjustable phase synchronization**

**Internal 2.5 V reference**

**Two power modes optimizing power dissipation and performance: high resolution mode and low power mode**

**Low resolution successive approximation register (SAR) ADC for system and chip diagnostics**

**Power supply**

**Bipolar (±1.65 V) or unipolar (3.3 V) supplies**

**Digital input/output (I/O) supply: 1.8 V to 3.6 V**

**Performance temperature range: -40°C to +105°C**

**Functional temperature range: -40°C to +125°C**

**Performance**

**Combined ac and dc performance**

**103 dB dynamic range at 32 kSPS in high resolution mode**

**-109 dB total harmonic distortion (THD)**

**±9 ppm of FSR integral nonlinearity (INL)**

**±15 µV offset error**

**±0.1% FS gain error**

**±10 ppm/°C typical temperature coefficient**

## APPLICATIONS

**Protection relays**

**General-purpose data acquisition**

**Industrial process control**

## GENERAL DESCRIPTION

The **AD7770** is an 8-channel, simultaneous sampling ADC. Eight full sigma-delta ( $\Sigma$ - $\Delta$ ) ADCs are on chip. The **AD7770** provides a low input current to allow direct sensor connection. Each input channel has a programmable gain stage allowing gains of 1, 2, 4, and 8 to map lower amplitude sensor outputs into the full-scale ADC input range, maximizing the dynamic range of the signal chain. The **AD7770** accepts a  $V_{REF}$  voltage from 1 V up to 3.6 V.

The analog inputs accept unipolar (0 V to  $V_{REF}$ ) or true bipolar ( $\pm V_{REF}/2$ ) analog input signals with 3.3 V or  $\pm 1.65$  V analog supply voltages, respectively for  $PGA_{GAIN} = 1$ . The analog inputs can be configured to accept true differential, pseudo differential, or single-ended signals to match different sensor output configurations.

Each channel contains a PGA, an ADC modulator and a sinc3, low latency digital filter. An SRC is provided to allow fine resolution control over the **AD7770** ODR. This control can be used in applications where the ODR resolution is required to maintain coherency with 0.01 Hz changes in the line frequency. The SRC is programmable through the serial port interface (SPI). The **AD7770** implements two different interfaces: a data output interface and SPI control interface. The ADC data output interface is dedicated to transmitting the ADC conversion results from the **AD7770** to the processor. The SPI writes to and reads from the **AD7770** configuration registers and for the control and reading of data from the SAR ADC. The SPI can also be configured to output the  $\Sigma$ - $\Delta$  conversion data.

The **AD7770** includes a 12-bit SAR ADC. This ADC can be used for **AD7770** diagnostics without having to decommission one of the  $\Sigma$ - $\Delta$  ADC channels dedicated to system measurement functions. With the use of an external multiplexer, which can be controlled through the three general-purpose input/output pins (GPIOs), and signal conditioning, the SAR ADC can validate the  $\Sigma$ - $\Delta$  ADC measurements in applications where functional safety is required. In addition, the **AD7770** SAR ADC includes an internal multiplexer to sense internal nodes.

The **AD7770** contains a 2.5 V reference and reference buffer. The reference has a typical temperature coefficient of 10 ppm/°C.

The **AD7770** offers two modes of operation: high resolution mode and low power mode. High resolution mode provides a higher dynamic range while consuming 10.75 mW per channel; low power mode consumes just 3.37 mW per channel at a reduced dynamic range specification.

The specified operating temperature range is -40°C to +105°C, although the device is operational up to +125°C.

Note that throughout this data sheet, certain terms are used to refer to either the multifunction pins or a range of pins. The multifunction pins, such as DCLK0/SDO, are referred to either by the entire pin name or by a single function of the pin, for example, DCLK0, when only that function is relevant. In the case of ranges of pins, AVSSx refers to the following pins: AVSS1A, AVSS1B, AVSS2A, AVSS2B, AVSS3, and AVSS4.

Rev. C

**Document Feedback**

Information furnished by Analog Devices is believed to be accurate and reliable. However, no responsibility is assumed by Analog Devices for its use, nor for any infringements of patents or other rights of third parties that may result from its use. Specifications subject to change without notice. No license is granted by implication or otherwise under any patent or patent rights of Analog Devices. Trademarks and registered trademarks are the property of their respective owners.

# AD7770\* PRODUCT PAGE QUICK LINKS

Last Content Update: 08/30/2017

---

## COMPARABLE PARTS

View a parametric search of comparable parts.

## EVALUATION KITS

- AD7770 / AD7771 / AD7779 Evaluation Board

## DOCUMENTATION

### Application Notes

- AN-1388: Coherent Sampling for Power Quality Measurements Using the AD7779 24-Bit Simultaneous Sampling Sigma-Delta ADC
- AN-1392: How to Calculate Offset Errors and Input Impedance in ADC Converters with Chopped Amplifiers
- AN-1393: Translating System Level Protection and Measurement Requirements to ADC Specifications
- AN-1405: Diagnostic Features on the AD7770 and AD7779

### Data Sheet

- AD7770: 8-Channel, 24-Bit, Simultaneous Sampling ADC Data Sheet

### User Guides

- UG-884: Evaluating the AD7770, AD7771, and AD7779 8-Channel, 24-Bit, Simultaneous Sampling, Sigma-Delta ADCs with Power Scaling

## SOFTWARE AND SYSTEMS REQUIREMENTS

- AD7770/AD7771/AD7779 - No-OS Driver

## TOOLS AND SIMULATIONS

- AD7770 CRC Calculator
- AD7770/AD7771/AD7779 Filter Model
- AD7770/AD7771/AD7779 IBIS Model

## REFERENCE MATERIALS

### Press

- Analog Devices Improves Monitoring and Protection of Smart Grid Transmission and Distribution Equipment

## DESIGN RESOURCES

- AD7770 Material Declaration
- PCN-PDN Information
- Quality And Reliability
- Symbols and Footprints

## DISCUSSIONS

View all AD7770 EngineerZone Discussions.

## SAMPLE AND BUY

Visit the product page to see pricing options.

## TECHNICAL SUPPORT

Submit a technical question or find your regional support number.

## DOCUMENT FEEDBACK

Submit feedback for this data sheet.

---

## TABLE OF CONTENTS

Features .....	1	$\Sigma$ - $\Delta$ Output Data.....	51
Applications.....	1	ADC Conversion Output—Header and Data .....	51
General Description .....	1	SRC (SPI Control Mode).....	52
Revision History .....	4	Data Output Interface.....	53
Functional Block Diagram .....	5	Calculating the CRC Checksum .....	58
Specifications.....	6	Register Summary .....	60
DOUTx Timing Characteristics.....	10	Register Details .....	64
SPI Timing Characteristics .....	11	Channel 0 Configuration Register .....	64
Synchronization Pins and Reset Timing Characteristics .....	12	Channel 1 Configuration Register .....	64
SAR ADC Timing Characteristics .....	13	Channel 2 Configuration Register .....	65
GPIO SRC Update Timing Characteristics.....	13	Channel 3 Configuration Register .....	65
Absolute Maximum Ratings.....	14	Channel 4 Configuration Register .....	66
Thermal Resistance .....	14	Channel 5 Configuration Register .....	66
ESD Caution.....	14	Channel 6 Configuration Register .....	67
Pin Configuration and Function Descriptions.....	15	Channel 7 Configuration Register .....	67
Typical Performance Characteristics .....	18	Disable Clocks to ADC Channel Register .....	68
Terminology .....	31	Channel 0 Sync Offset Register .....	68
Theory of Operation .....	33	Channel 1 Sync Offset Register .....	68
Analog Inputs.....	33	Channel 2 Sync Offset Register .....	68
Transfer Function .....	34	Channel 3 Sync Offset Register .....	69
Core Signal Chain.....	35	Channel 4 Sync Offset Register .....	69
Capacitive PGA.....	35	Channel 5 Sync Offset Register .....	69
Internal Reference and Reference Buffers.....	35	Channel 6 Sync Offset Register .....	69
Integrated LDOs .....	36	Channel 7 Sync Offset Register .....	69
Clocking and Sampling.....	36	General User Configuration 1 Register .....	70
Digital Reset and Synchronization Pins .....	36	General User Configuration 2 Register .....	70
Digital Filtering.....	37	General User Configuration 3 Register.....	71
Shutdown Mode.....	37	Data Output Format Register .....	72
Controlling the AD7770 .....	38	Main ADC Meter and Reference Mux Control Register .....	73
Pin Control Mode.....	38	Global Diagnostics Mux Register.....	74
SPI Control.....	40	GPIO Configuration Register.....	74
Digital SPI.....	43	GPIO Data Register.....	75
RMS Noise and Resolution.....	46	Buffer Configuration 1 Register .....	75
High Resolution Mode.....	46	Buffer Configuration 2 Register .....	75
Low Power Mode.....	46	Channel 0 Offset Upper Byte Register.....	76
Diagnostics and Monitoring .....	47	Channel 0 Offset Middle Byte Register .....	76
Self Diagnostics Error .....	47	Channel 0 Offset Lower Byte Register.....	76
Monitoring Using the AD7770 SAR ADC (SPI Control Mode).....	48	Channel 0 Gain Upper Byte Register.....	76
$\Sigma$ - $\Delta$ ADC Diagnostics (SPI Control Mode).....	50	Channel 0 Gain Middle Byte Register .....	76
		Channel 0 Gain Lower Byte Register.....	77

Channel 1 Offset Upper Byte Register .....	77	Channel 6 Gain Lower Byte Register .....	84
Channel 1 Offset Middle Byte Register .....	77	Channel 7 Offset Upper Byte Register .....	84
Channel 1 Offset Lower Byte Register .....	77	Channel 7 Offset Middle Byte Register .....	84
Channel 1 Gain Upper Byte Register .....	78	Channel 7 Offset Lower Byte Register .....	85
Channel 1 Gain Middle Byte Register .....	78	Channel 7 Gain Upper Byte Register .....	85
Channel 1 Gain Lower Byte Register .....	78	Channel 7 Gain Middle Byte Register .....	85
Channel 2 Offset Upper Byte Register .....	78	Channel 7 Gain Lower Byte Register .....	85
Channel 2 Offset Middle Byte Register .....	78	Channel 0 Status Register .....	86
Channel 2 Offset Lower Byte Register .....	79	Channel 1 Status Register .....	86
Channel 2 Gain Upper Byte Register .....	79	Channel 2 Status Register .....	87
Channel 2 Gain Middle Byte Register .....	79	Channel 3 Status Register .....	87
Channel 2 Gain Lower Byte Register .....	79	Channel 4 Status Register .....	88
Channel 3 Offset Upper Byte Register .....	79	Channel 5 Status Register .....	88
Channel 3 Offset Middle Byte Register .....	80	Channel 6 Status Register .....	89
Channel 3 Offset Lower Byte Register .....	80	Channel 7 Status Register .....	89
Channel 3 Gain Upper Byte Register .....	80	Channel 0/Channel 1 DSP Errors Register .....	90
Channel 3 Gain Middle Byte Register .....	80	Channel 2/Channel 3 DSP Errors Register .....	90
Channel 3 Gain Lower Byte Register .....	80	Channel 4/Channel 5 DSP Errors Register .....	91
Channel 4 Offset Upper Byte Register .....	81	Channel 6/Channel 7 DSP Errors Register .....	91
Channel 4 Offset Middle Byte Register .....	81	Channel 0 to Channel 7 Error Register Enable Register .....	92
Channel 4 Offset Lower Byte Register .....	81	General Errors Register 1 .....	92
Channel 4 Gain Upper Byte Register .....	81	General Errors Register 1 Enable .....	93
Channel 4 Gain Middle Byte Register .....	81	General Errors Register 2 .....	93
Channel 4 Gain Lower Byte Register .....	82	General Errors Register 2 Enable .....	94
Channel 5 Offset Upper Byte Register .....	82	Error Status Register 1 .....	94
Channel 5 Offset Middle Byte Register .....	82	Error Status Register 2 .....	95
Channel 5 Offset Lower Byte Register .....	82	Error Status Register 3 .....	95
Channel 5 Gain Upper Byte Register .....	82	Decimation Rate (N) MSB Register .....	95
Channel 5 Gain Middle Byte Register .....	83	Decimation Rate (N) LSB Register .....	96
Channel 5 Gain Lower Byte Register .....	83	Decimation Rate (IF) MSB Register .....	96
Channel 6 Offset Upper Byte Register .....	83	Decimation Rate (IF) LSB Register .....	96
Channel 6 Offset Middle Byte Register .....	83	SRC Load Source and Load Update Register .....	96
Channel 6 Offset Lower Byte Register .....	83	Outline Dimensions .....	97
Channel 6 Gain Upper Byte Register .....	84	Ordering Guide .....	97
Channel 6 Gain Middle Byte Register .....	84		

**REVISION HISTORY****8/2017—Rev. B to Rev. C**

Changes to Features Section and General Description Section.....	1
Change to START Pin Description, Table 9.....	15
Changes to Figure 48.....	24
Change to Digital Reset and Synchronization Pins Section and Internal Reference and Reference Buffers Section.....	36
Change to Figure 95.....	37
Changes to Phase Adjustment Section and Table 16.....	41
Added Table 17; Renumbered Sequentially.....	41
Change to Digital SPI Section.....	43
Change to Table 25.....	46

**10/2016—Rev. A to Rev. B**

Changes to Figure 45.....	24
Changes to Figure 56, Figure 59, and Figure 61.....	26
Changes to Figure 72 and Figure 73.....	28
Changes to Figure 76.....	29
Added Figure 82; Renumbered Sequentially.....	30
Changes to Figure 86 to Figure 89.....	34

**Changes to SPI Transmission Errors (SPI Control Mode)**

Section.....	48
Changes to Table 33 and Table 34.....	51
Changes to SRC Group Delay and Latency Section and Settling Time Section.....	53
Changes to Table 39 and Table 40.....	57
Changes to Calculating the CRC Checksum Section and Table 42.....	58
Changes to Ordering Guide.....	97

**5/2016—Rev. 0 to Rev. A**

Change to Features.....	1
Changes to Table 1.....	6
Changes to Figure 33 and Figure 36.....	21
Change to Figure 78.....	28

**4/2016—Revision 0: Initial Version**

# FUNCTIONAL BLOCK DIAGRAM

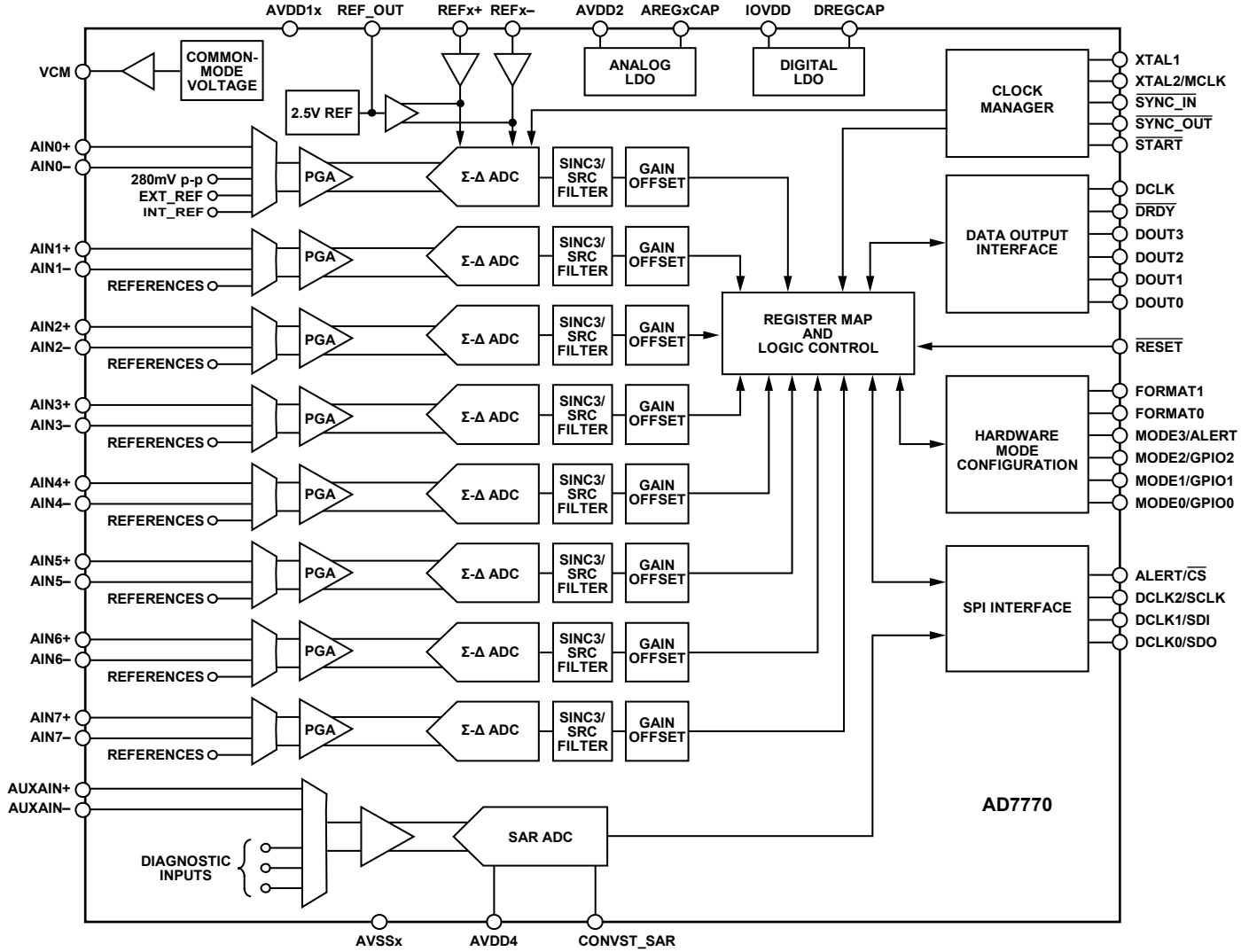

Figure 1.

12538-001

## SPECIFICATIONS

AVDD1x = 1.65 V, AVSSx<sup>1</sup> = -1.65 V (dual supply operation), AVDD1x = 3.3 V, AVSSx = analog ground (AGND) (single-supply operation), AVDD2x - AVSSx = 2.2 V to 3.6 V; IOVDD = 1.8 V to 3.6 V; DGND = 0 V, REFx+/REFx- = 2.5 V (internal/external), master clock (MCLK) = 8192 kHz for high resolution mode and 4096 kHz for low power mode, ODR = 32 kSPS for high resolution mode and 8 kSPS for low power mode; all specifications at T<sub>MIN</sub> to T<sub>MAX</sub>, unless otherwise noted.

Table 1.

Parameter	Test Conditions/Comments	Min	Typ	Max	Unit
<b>ANALOG INPUTS</b>					
Differential Input Voltage Range	$V_{REF} = (REFx+ - REFx-)$			$\pm V_{REF}/PGA_{GAIN}$	V
Single-Ended Input Voltage Range				0 to $V_{REF}/PGA_{GAIN}$	V
AINx± Common-Mode Input Range		AVSSx + 0.10	(AVDD1x + AVSSx)/2	AVDD1x - 0.10	V
Absolute AINx± Voltage Limits		AVSSx + 0.10		AVDD1x - 0.10	V
DC Input Current					
Differential	High resolution, MCLK = 8192 kHz		4		nA
	Low power mode, MCLK = 4096 kHz		1		nA
Single-Ended	High resolution, MCLK = 8192 kHz		8		nA
	Low power mode, MCLK = 4096 kHz		2		nA
Input Current Drift			50		pA/°C
AC Input Capacitance			8		pF
<b>PGA</b>					
Gain Settings, PGA <sub>GAIN</sub>			1, 2, 4, or 8		
Bandwidth	Small signal, high resolution mode			2	MHz
	Small signal, low power mode			512	kHz
	Large signal, high resolution mode			5	kHz
	Large signal, low power mode			1.5	kHz
<b>REFERENCE</b>					
<b>Internal</b>					
Initial Accuracy	REF_OUT, T <sub>A</sub> = 25°C	2.495	2.5	2.505	V
Temperature Coefficient			±10	±38	ppm/°C
Reference Load Current, I <sub>L</sub>		-10		+10	mA
DC Power Supply Rejection	Line regulation		95		dB
Load Regulation, $\Delta V_{OUT}/\Delta I_L$			100		μV/mA
Voltage Noise, e <sub>N p-p</sub>	0.1 Hz to 10 Hz		6.8		μV rms
Voltage Noise Density, e <sub>N</sub>	1 kHz, 2.5 V reference		273.5		nV/√Hz
Turn On Settling Time	100 nF		1.5		ms
<b>External</b>					
Input Voltage	$V_{REF} = (REFx+ - REFx-)$	1	2.5	AVDD1x	V
Buffer Headroom		AVSSx + 0.1		AVDD1x - 0.1	V
REFx- Input Voltage			AVSSx	AVDD1x - REFx+	V
Average REFx± Input Current	Current per channel				
	Reference buffer disabled, high resolution mode		18		μA/V
	Reference buffer precharge mode (pre-Q), high resolution mode		600		nA/V
	Reference buffer disabled, low power mode		4.5		μA/V
	Reference buffer pre-Q, low power mode		100		nA/V
	Reference buffer enabled, high resolution mode		12		nA/V
	Reference buffer enabled, low power mode		5		nA/V

Parameter	Test Conditions/Comments	Min	Typ	Max	Unit
TEMPERATURE RANGE					
Specified Performance	$T_{MIN}$ to $T_{MAX}$	-40		+105	°C
Functional <sup>2</sup>	$T_{MIN}$ to $T_{MAX}$	-40		+125	°C
TEMPERATURE SENSOR					
Accuracy			±2		°C
DIGITAL FILTER RESPONSE (SINC3)					
Group Delay			See the SRC Group Delay section		
Settling Time			See the Settling Time section		
Pass Band	-0.1 dB -3 dB		See the SRC Bandwidth section See the SRC Bandwidth section		
Decimation Rate		64		4095.99	
CLOCK SOURCE					
Frequency	High resolution mode Low power mode	0.655 1.3		8.192 4.096	MHz MHz
Duty Cycle		45:55	50:50	55:45	%
Σ-Δ ADC					
Speed and Performance					
Resolution		24			Bits
ODR	High resolution mode Low power mode			32 8	kSPS kSPS
No Missing Codes	Up to 24 kSPS	24			Bits
AC Accuracy					
Dynamic Range	Shorted inputs, $PGA_{GAIN} = 1$				
32 kSPS	High resolution mode		103		dB
8 kSPS	High resolution mode Low power mode		113 103		dB dB
2 kSPS	Low power mode		113		dB
THD	-0.5 dBFS, high resolution mode -0.5 dBFS, low power mode		-109 -105		dB dB
Signal-to-Noise-and-Distortion Ratio (SINAD)	$f_{IN} = 60$ Hz		106		dB
SFDR	High resolution mode, 16 kSPS, $PGA_{GAIN} = 1$		132		dB
Intermodulation Distortion (IMD)	$f_A = 50$ Hz, $f_B = 51$ Hz, high resolution mode $f_A = 50$ Hz, $f_B = 51$ Hz, low power mode		-125 -105		dB dB
DC Power Supply Rejection	$AVDD1x = 3.3$ V		-90		dB
DC Common-Mode Rejection Ratio		80			dB
Crosstalk			-120		dB
DC ACCURACY					
INL					
High Resolution Mode	Endpoint method, $PGA_{GAIN} = 1$ Other PGA gains		±8 ±4	±15 ±15	ppm of FSR ppm of FSR
Low Power Mode	Endpoint method, $PGA_{GAIN} = 1$ Other PGA gains		±9 ±6	±17 ±15	ppm of FSR ppm of FSR
Offset Error			±15	±90	μV
Offset Error Drift	Over time		±0.25 -2		μV/°C μV/ 1000 hours



Parameter	Test Conditions/Comments	Min	Typ	Max	Unit
Offset Matching			25		$\mu\text{V}$
Gain Error			$\pm 0.1$		% FS
Gain Drift vs. Temperature			$\pm 0.75$		ppm/ $^{\circ}\text{C}$
Gain Matching			$\pm 0.1$		%
<b>SAR ADC</b>					
Speed and Performance					
Resolution			12		Bits
Analog Input Range		$\text{AVSS4} + 0.1$		$\text{AVDD4} - 0.1$	V
Analog Input Common-Mode Range		$\text{AVSS4} + 0.1$	$(\text{AVDD4} + \text{AVSS4})/2$	$\text{AVDD4} - 0.1$	V
Analog Input Dynamic Current	256 kSPS, 0 dBFS		$\pm 100$		nA
Throughput				256	kSPS
DC Accuracy	Differential mode				
INL			1.5		LSB
DNL	No missing codes (12-bit)	-0.99		+1	LSB
Offset			$\pm 1$		LSB
Gain			12		LSB
AC Performance					
SNR	1 kHz		66		dB
THD	1 kHz		-81		dB
<b>VCM PIN</b>					
Output			$(\text{AVDD1x} + \text{AVSSx})/2$		V
Load Current, $I_L$			1		mA
Load Regulation, $\Delta V_{\text{OUT}}/\Delta I_L$			12		mV/mA
Short-Circuit Current			5		mA
<b>LOGIC INPUTS</b>					
Input Voltage					
High, $V_{\text{IH}}$		$0.7 \times \text{IOVDD}$			V
Low, $V_{\text{IL}}$				0.4	V
Hysteresis			0.1		V
Input Currents		-10		+10	$\mu\text{A}$
<b>LOGIC OUTPUTS<sup>3</sup></b>					
Output Voltage					
High, $V_{\text{OH}}$	$\text{IOVDD} \geq 3\text{ V}, I_{\text{SOURCE}} = 1\text{ mA}$	$0.8 \times \text{IOVDD}$			V
	$2.3\text{ V} \leq \text{IOVDD} < 3\text{ V}, I_{\text{SOURCE}} = 500\ \mu\text{A}$	$0.8 \times \text{IOVDD}$			V
	$\text{IOVDD} < 2.3\text{ V}, I_{\text{SOURCE}} = 200\ \mu\text{A}$	$0.8 \times \text{IOVDD}$			V
Low, $V_{\text{OL}}$	$\text{IOVDD} \geq 3\text{ V}, I_{\text{SINK}} = 2\text{ mA}$			0.4	V
	$2.3\text{ V} \leq \text{IOVDD} < 3\text{ V}, I_{\text{SINK}} = 1\text{ mA}$			0.4	V
	$\text{IOVDD} < 2.3\text{ V}, I_{\text{SINK}} = 100\ \mu\text{A}$			0.4	V
Leakage Current	Floating state	-10		+10	$\mu\text{A}$
Output Capacitance	Floating state		10		pF
$\Sigma$ - $\Delta$ ADC Data Output Coding			Twos complement		
SAR ADC Data Output Coding			Binary		

Parameter	Test Conditions/Comments	Min	Typ	Max	Unit
POWER SUPPLIES	All $\Sigma$ - $\Delta$ channels enabled				
AVDD1x – AVSSx		3.0		3.6	V
$I_{AVDD1x}$ <sup>4,5</sup>	Reference buffer pre-Q, VCM enabled, internal reference enabled				
	High resolution mode		18.5	23.7	mA
	Low power mode		5	6.4	mA
	Reference buffer enabled, VCM enabled, internal reference enabled				
	High resolution mode		20.5	26.7	mA
	Low power mode		5.5	7.1	mA
	Reference buffer disabled, VCM disabled, internal reference disabled				
	High resolution mode		14.3	18.8	mA
	Low power mode		3.9	5.1	mA
AVDD2x – AVSSx		2.2		3.6	V
$I_{AVDD2x}$	High resolution mode		9	9.45	mA
	Low power mode		3.5	3.7	mA
AVDD4 – AVSSx		AVDD1x – 0.3		AVDD1x	V
$I_{AVDD4}$	SAR enabled		1.7	2	mA
	SAR disabled		1	10	$\mu$ A
AVSSxV – DGND		–1.8		0	V
IOVDD – DGND		1.8		3.6	V
$I_{IOVDD}$	High resolution mode		8	11.3	mA
	Low power mode		3	4.4	mA
Power Dissipation <sup>6</sup>	Internal buffers bypassed, internal reference disabled, internal oscillator disabled, SAR disabled				
High Resolution Mode	32 kSPS		117	136	mW
Low Power Mode	8 kSPS		38	44	mW
Power-Down	All ADCs disabled		530		$\mu$ W

<sup>1</sup> AVSSx refers to the following pins: AVSS1A, AVSS1B, AVSS2A, AVSS2B, AVSS3, and AVSS4. This term is used throughout the data sheet.

<sup>2</sup> At temperatures higher than 105°C, the device can be operated normally, though slight degradation on the maximum/minimum specifications is expected because these specifications are only guaranteed up to 105°C. See the Typical Performance Characteristics section for plots showing the typical performance of the device at high temperatures.

<sup>3</sup> The SDO pin and the DOUTx pin are configured in the default mode of strength.

<sup>4</sup> AVDD1x = 3.3 V, AVSSx = GND = ground, IOVDD = 1.8 V, CMOS clock.

<sup>5</sup> Disabling either the VCM pin or the internal reference results in a 40  $\mu$ A typical current consumption reduction.

<sup>6</sup> Power dissipation is calculated using the maximum supply voltage, 3.6 V.

**DOUTx TIMING CHARACTERISTICS**

AVDD1x = 1.65 V, AVSSx<sup>1</sup> = -1.65 V (dual supply operation), AVDD1x = 3.3 V, AVSSx = AGND (single-supply operation), AVDD2 – AVSSx = 2.2 V to 3.6 V; IOVDD = 1.8 V to 3.6 V; DGND = 0 V, REFx+/REFx- = 2.5 V internal/external, MCLK = 8192 kHz; all specifications at T<sub>MIN</sub> to T<sub>MAX</sub>, unless otherwise noted.

**Table 2.**

Parameter	Description <sup>2</sup>	Test Conditions/Comments	Min	Typ	Max	Unit
t <sub>1</sub>	MCLK frequency	50:50	0.655		8.192	MHz
t <sub>2</sub>	MCLK low time		60			ns
t <sub>3</sub>	MCLK high time		60			ns
t <sub>4</sub>	DCLK high time	MCLK/2	121			ns
t <sub>5</sub>	DCLK low time	MCLK/2	121			ns
t <sub>6</sub>	MCLK falling edge to DCLK rising edge				45	ns
t <sub>7</sub>	MCLK falling edge to $\overline{\text{DCLK}}$ falling edge				45	ns
t <sub>8</sub>	DCLK rising edge to $\overline{\text{DRDY}}$ rising edge		2			ns
t <sub>9</sub>	DCLK rising edge to $\overline{\text{DRDY}}$ falling edge		1			ns
t <sub>10</sub>	DOUTx setup time		20			ns
t <sub>11</sub>	DOUTx hold time		20			ns

<sup>1</sup> AVSSx refers to the following pins: AVSS1A, AVSS1B, AVSS2A, AVSS2B, AVSS3, and AVSS4. This term is used throughout the data sheet.

<sup>2</sup> All input signals are specified with t<sub>r</sub> = t<sub>f</sub> = 1 ns/V (10% to 90% of IOVDD) and timed from a voltage level of (V<sub>IL</sub> + V<sub>IH</sub>)/2.

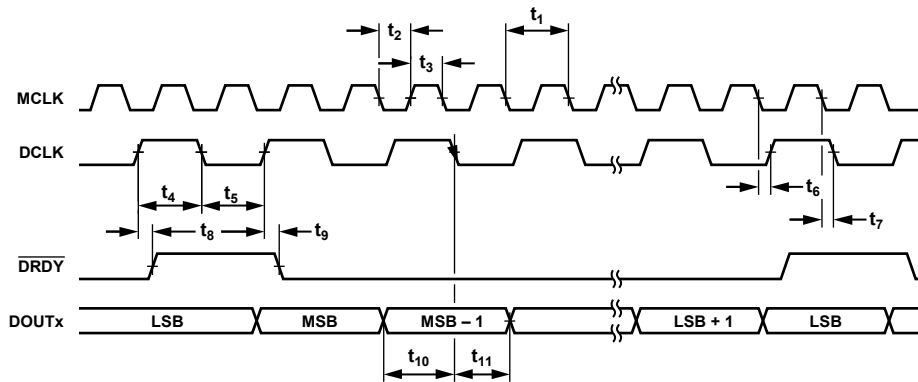

Figure 2. Data Interface Timing Diagram

12538-002

**SPI TIMING CHARACTERISTICS**

AVDD1x = 1.65 V, AVSSx<sup>1</sup> = -1.65 V (dual supply operation), AVDD1x = 3.3 V, AVSSx = AGND, AVDD2 – AVSSx = 2.2 V to 3.6 V; IOVDD = 1.8 V to 3.6 V; DGND = 0 V, REFx+/REFx- = 2.5 V (internal/external), MCLK = 8192 kHz; all specifications at T<sub>MIN</sub> to T<sub>MAX</sub>, unless otherwise noted.

Table 3.

Parameter	Description <sup>2</sup>	Test Conditions/Comments	Min	Typ	Max	Unit
t <sub>12</sub>	SCLK period	50:50			30	MHz
t <sub>13</sub>	SCLK low time		7			ns
t <sub>14</sub>	SCLK high time		7			ns
t <sub>15</sub>	SCLK rising edge to $\overline{CS}$ falling edge		10			ns
t <sub>16</sub>	$\overline{CS}$ falling edge to SCLK rising edge		10			ns
t <sub>17</sub>	SCLK rising edge to $\overline{CS}$ rising edge		10			ns
t <sub>18</sub>	$\overline{CS}$ rising edge to SCLK rising edge		10			ns
t <sub>19</sub>	Minimum $\overline{CS}$ high time		10			ns
t <sub>20</sub>	SDI setup time		5			ns
t <sub>21</sub>	SDI hold time		5			ns
t <sub>22A</sub>	$\overline{CS}$ falling edge to SDO enable (SPI = Mode 0)		30			ns
t <sub>22B</sub>	SCLK falling edge to SDO enable (SPI = Mode 1)		49			ns
t <sub>23</sub>	SDO setup time		10			ns
t <sub>24</sub>	SDO hold time		10			ns
t <sub>25</sub>	$\overline{CS}$ rising edge to SDO disable		30			ns

<sup>1</sup> AVSSx refers to the following pins: AVSS1A, AVSS1B, AVSS2A, AVSS2B, AVSS3, and AVSS4. This term is used throughout the data sheet.

<sup>2</sup> All input signals are specified with t<sub>r</sub> = t<sub>f</sub> = 1 ns/V (10% to 90% of IOVDD) and timed from a voltage level of (V<sub>IL</sub> + V<sub>IH</sub>)/2.

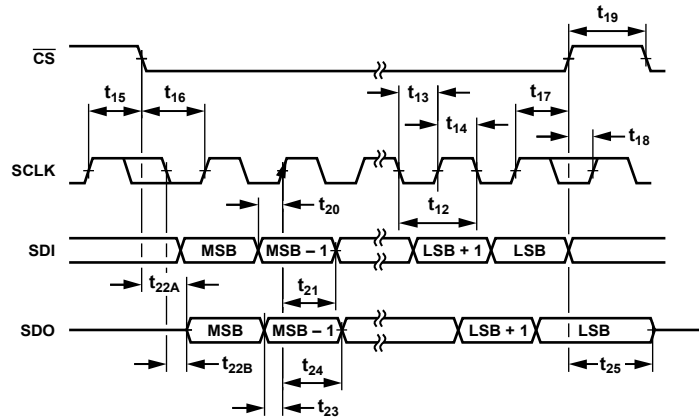

Figure 3. SPI Control Interface Timing Diagram

12538-003

### SYNCHRONIZATION PINS AND RESET TIMING CHARACTERISTICS

AVDD1x = 1.65 V, AVSSx<sup>1</sup> = -1.65 V (dual supply operation), AVDD1x = 3.3 V, AVSSx = AGND, AVDD2 – AVSSx = 2.2 V to 3.6 V; IOVDD = 1.8 V to 3.6 V; DGND = 0 V, REFx+/REFx- = 2.5 V (internal/external), MCLK = 8192 kHz; all specifications at T<sub>MIN</sub> to T<sub>MAX</sub>, unless otherwise noted.

Table 4.

Parameter	Description <sup>2</sup>	Test Conditions/Comments	Min	Typ	Max	Unit
t <sub>26</sub>	$\overline{\text{START}}$ setup time		10			ns
t <sub>27</sub>	$\overline{\text{START}}$ hold time		MCLK			ns
t <sub>28</sub>	MCLK falling edge to $\overline{\text{SYNC\_OUT}}$ falling edge		MCLK			ns
t <sub>29</sub>	$\overline{\text{SYNC\_IN}}$ setup time		10			ns
t <sub>30</sub>	$\overline{\text{SYNC\_IN}}$ hold time		MCLK			ns
t <sub>INIT_SYNC_IN</sub>	$\overline{\text{SYNC\_IN}}$ rising edge to first $\overline{\text{DRDY}}$	16 kSPS, high resolution mode	145			μs
t <sub>INIT_RESET</sub>	$\overline{\text{RESET}}$ rising edge to first $\overline{\text{DRDY}}$	16 kSPS, high resolution mode	225			μs
t <sub>31</sub>	$\overline{\text{RESET}}$ hold time		2 × MCLK			ns
t <sub>POWER_UP</sub>	Start time	t <sub>POWER_UP</sub> is not shown in Figure 4		2		ms

<sup>1</sup> AVSSx refers to the following pins: AVSS1A, AVSS1B, AVSS2A, AVSS2B, AVSS3, and AVSS4. This term is used throughout the data sheet.

<sup>2</sup> All input signals are specified with t<sub>r</sub> = t<sub>f</sub> = 1 ns/V (10% to 90% of IOVDD) and timed from a voltage level of (V<sub>IL</sub> + V<sub>IH</sub>)/2.

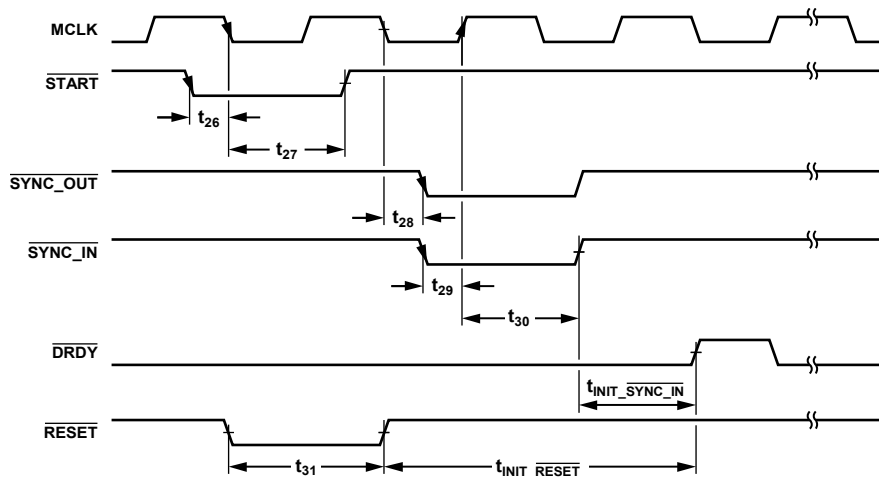

Figure 4. Synchronization Pins and Reset Control Interface Timing Diagram

12538-004

**SAR ADC TIMING CHARACTERISTICS**

AVDD1x = 1.65 V, AVSSx<sup>1</sup> = -1.65 V (dual supply operation), AVDD1x = 3.3 V, AVSSx = AGND, AVDD2 – AVSSx = 2.2 V to 3.6 V; IOVDD = 1.8 V to 3.6 V; DGND = 0 V, REFx+/REFx- = 2.5 V (internal/external), MCLK = 8192 kHz; all specifications at T<sub>MIN</sub> to T<sub>MAX</sub>, unless otherwise noted.

Table 5.

Parameter	Description <sup>2</sup>	Min	Typ	Max	Unit
t <sub>32</sub>	Conversion time	1		3.4	μs
t <sub>33</sub>	Acquisition time <sup>3</sup>	500			ns
t <sub>34</sub>	Delay time	50			ns
t <sub>35</sub>	Throughput data rate			256	kSPS

<sup>1</sup> AVSSx refers to the following pins: AVSS1A, AVSS1B, AVSS2A, AVSS2B, AVSS3 and AVSS4. This term is used throughout the data sheet.

<sup>2</sup> All input signals are specified with t<sub>r</sub> = t<sub>f</sub> = 1 ns/V (10% to 90% of IOVDD) and timed from a voltage level of (V<sub>IL</sub> + V<sub>HI</sub>)/2.

<sup>3</sup> Direct mode enabled. If deglitch mode is enabled, add 1.5/MCLK as described in Table 30.

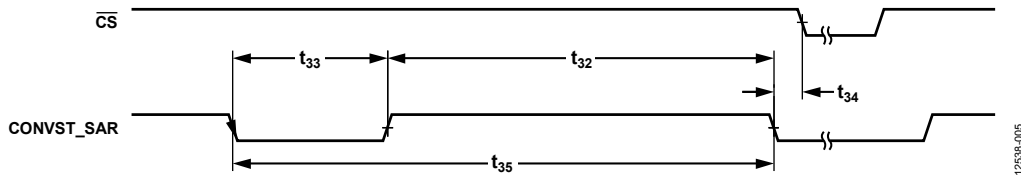

Figure 5. SAR ADC Timing Diagram

**GPIO SRC UPDATE TIMING CHARACTERISTICS**

AVDD1x = 1.65 V, AVSSx<sup>1</sup> = -1.65 V (dual supply operation), AVDD1x = 3.3 V, AVSSx = AGND, AVDD2 – AVSSx = 2.2 V to 3.6 V; IOVDD = 1.8 V to 3.6 V; DGND = 0 V, REFx+/REFx- = 2.5 V (internal/external), MCLK = 8192 kHz; all specifications T<sub>MIN</sub> to T<sub>MAX</sub>, unless otherwise noted.

Table 6.

Parameter	Description <sup>2</sup>	Min	Typ	Max	Unit
t <sub>36</sub>	GPIO2 setup time	10			ns
	GPIO2 hold time				
t <sub>37</sub>	High resolution mode	MCLK			ns
t <sub>37</sub>	Low power mode	2 × MCLK			
t <sub>38</sub>	MCLK rising edge to GPIO1 rising edge time	20			ns
t <sub>39</sub>	GPIO0 setup time	5			ns
t <sub>40</sub>	GPIO0 hold time	MCLK			ns

<sup>1</sup> AVSSx refers to the following pins: AVSS1A, AVSS1B, AVSS2A, AVSS2B, AVSS3 and AVSS4. This term is used throughout the data sheet.

<sup>2</sup> All input signals are specified with t<sub>r</sub> = t<sub>f</sub> = 1 ns/V (10% to 90% of IOVDD) and timed from a voltage level of (V<sub>IL</sub> + V<sub>HI</sub>)/2.

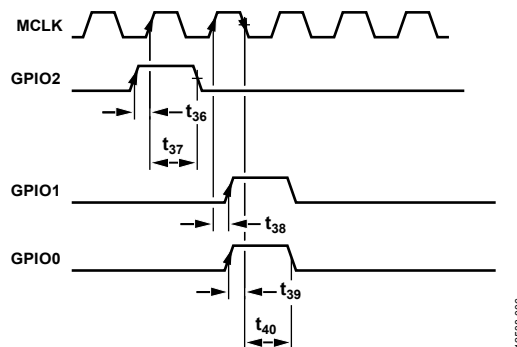

Figure 6. GPIOs for SRC Update Timing Diagram

## ABSOLUTE MAXIMUM RATINGS

Table 7.

Parameter	Rating
Any Supply Pin to AVSSx	−0.3 V to +3.96 V
AVSSx to DGND	−1.98 V to +0.3 V
AREGxCAP to AVSSx	−0.3 V to +1.98 V
DREGCAP to DGND	−0.3 V to +1.98 V
IOVDD to DGND	−0.3 V to +3.96 V
IOVDD to AVSSx	−0.3 V to +5.94 V
AVDD4 to AVSSx	AVDD1x − 0.3 V to 3.96 V
Analog Input Voltage	AVSSx − 0.3 V to AVDD1x + 0.3 V or 3.96 V (whichever is less)
REFx± Input Voltage	AVSSx − 0.3 V to AVDD1x + 0.3 V or 3.96 V (whichever is less)
AUXAIN±	AVSSx − 0.3 V to AVDD4 + 0.1 V or 3.96 V (whichever is less)
Digital Input Voltage to DGND	DGND − 0.3 V to IOVDD + 0.3 V or 3.96 V (whichever is less)
Digital Output Voltage to DGND	DGND − 0.3 V to IOVDD + 0.3 V or 3.96 V (whichever is less)
XTAL1 to DGND	DGND − 0.3 V to DREGCAP + 0.3 V or 1.98 V (whichever is less)
AINx±, AUXAIN±, and Digital Input Current	±10 mA
Operating Temperature Range	−40°C to +125°C
Junction Temperature, T <sub>J</sub> Maximum	150°C
Storage Temperature Range	−65°C to +150°C
Reflow Soldering	260°C
ESD	2 kV
Field Induced Charged Device Model (FICDM)	500 V

Stresses at or above those listed under Absolute Maximum Ratings may cause permanent damage to the product. This is a stress rating only; functional operation of the product at these or any other conditions above those indicated in the operational section of this specification is not implied. Operation beyond the maximum operating conditions for extended periods may affect product reliability.

### THERMAL RESISTANCE

Thermal performance is directly linked to printed circuit board (PCB) design and operating environment. Close attention to PCB thermal design is required.

Table 8. Thermal Resistance

Package Type <sup>1</sup>	$\theta_{JA}$	$\theta_{JB}$	$\Psi_{JT}$	$\Psi_{JB}$	Unit
64-Lead LFCSP					
No Thermal Vias	30.43	N/A <sup>2</sup>	0.13	6.59	°C/W
49 Thermal Vias	22.62	3.17	0.09	3.19	°C/W

<sup>1</sup> Thermal impedance simulated values are based on a JEDEC 2S2P thermal test board. See JEDEC JESD51.

<sup>2</sup> N/A means not applicable.

### ESD CAUTION



**ESD (electrostatic discharge) sensitive device.** Charged devices and circuit boards can discharge without detection. Although this product features patented or proprietary protection circuitry, damage may occur on devices subjected to high energy ESD. Therefore, proper ESD precautions should be taken to avoid performance degradation or loss of functionality.

# PIN CONFIGURATION AND FUNCTION DESCRIPTIONS

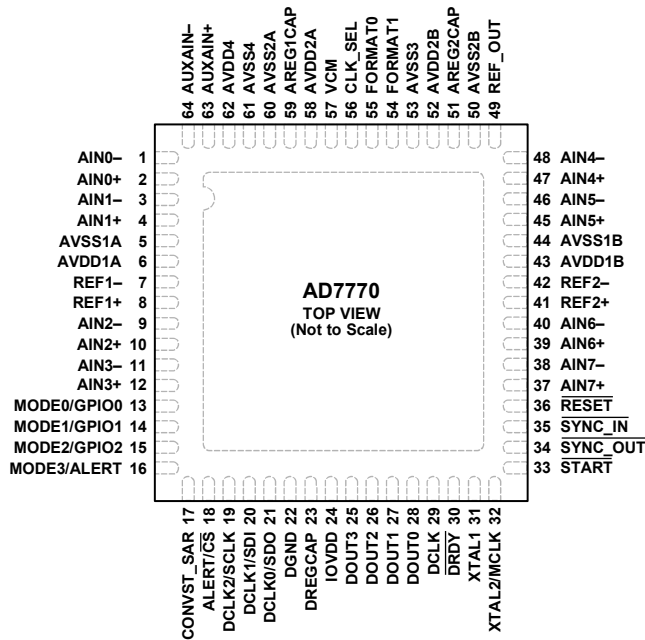

NOTES  
1. EXPOSED PAD. CONNECT THE EXPOSED PAD TO AVSSx.

Figure 7. Pin Configuration

125398-007

Table 9. Pin Function Descriptions

Pin No.	Mnemonic	Type	Direction	Description
1	AIN0-	Analog input	Input	Analog Input Channel 0, Negative.
2	AIN0+	Analog input	Input	Analog Input Channel 0, Positive.
3	AIN1-	Analog input	Input	Analog Input Channel 1, Negative.
4	AIN1+	Analog input	Input	Analog Input Channel 1, Positive.
5	AVSS1A	Supply	Supply	Negative Front-End Analog Supply for Channel 0 to Channel 3, Typical at $-1.65\text{ V}$ (Dual Supply) or AGND (Single Supply). Connect all the AVSSx pins to the same potential.
6	AVDD1A	Supply	Supply	Positive Front-End Analog Supply for Channel 0 to Channel 3, Typical at AVSSx + 3.3 V. Connect this pin to AVDD1B.
7	REF1-	Reference	Input	Negative Reference Input 1 for Channel 0 to Channel 3, Typical at AVSSx. Connect all the REFx- pins to the same potential.
8	REF1+	Reference	Input	Positive Reference Input 1 for Channel 0 to Channel 3, Typical at REF1- + 2.5 V.
9	AIN2-	Analog input	Input	Analog Input Channel 2, Negative.
10	AIN2+	Analog input	Input	Analog Input Channel 2, Positive.
11	AIN3-	Analog input	Input	Analog Input Channel 3, Negative.
12	AIN3+	Analog input	Input	Analog Input Channel 3, Positive.
13	MODE0/GPIO0	Digital I/O	I/O	Mode 0 Input in Pin Control Mode (MODE0). See Table 14 for more details. Configurable General-Purpose Input/Output 0 in SPI Control Mode (GPIO0). If not in use, connect this pin to DGND or IOVDD.
14	MODE1/GPIO1	Digital I/O	I/O	Mode 1 Input in Pin Control Mode (MODE1). See Table 14 for more details. Configurable General-Purpose Input/Output 1 in SPI Control Mode (GPIO1). If not in use, connect this pin to DGND or IOVDD.



Pin No.	Mnemonic	Type	Direction	Description
15	MODE2/GPIO2	Digital I/O	I/O	Mode 2 Input in Pin Control Mode (MODE2). See Table 14 for more details. Configurable General-Purpose Input/Output 2 in SPI Control Mode (GPIO2). If not in use, connect this pin to DGND or IOVDD.
16	MODE3/ALERT	Digital I/O	I/O	Mode 3 Input in Pin Control Mode (MODE3). See Table 14 for more details. Alert Output in SPI Control Mode (ALERT).
17	CONVST_SAR	Digital input	Input	$\Sigma$ - $\Delta$ Output Interface Selection Pin in Pin Control Mode. See Table 13 for more details. This pin also functions as the start for the SAR conversion in SPI control mode.
18	ALERT/ $\overline{CS}$	Digital input	Input	Alert Output in Pin Control Mode (ALERT). Chip Select in SPI Control Mode ( $\overline{CS}$ ).
19	DCLK2/SCLK	Digital input	Input	DCLK Frequency Selection Pin 2 in Pin Control Mode (DCLK2). See Table 15 for more details. SPI Clock in SPI Control Mode (SCLK).
20	DCLK1/SDI	Digital input	Input	DCLK Frequency Selection Pin 1 in Pin Control Mode (DCLK1). See Table 15 for more details. SPI Data Input in SPI Control Mode (SDI). Connect this pin to DGND if the device is configured in pin control mode with the SPI as the data output interface.
21	DCLK0/SDO	Digital output	Output	DCLK Frequency Selection Pin 0 in Pin Control Mode (DCLK0). See Table 15 for more details. SPI Data Output in SPI Control Mode (SDO).
22	DGND	Supply	Supply	Digital Ground.
23	DREGCAP	Supply	Output	Digital Low Dropout (LDO) Output. Decouple this pin to DGND with a 1 $\mu$ F capacitor.
24	IOVDD	Supply	Supply	Digital Levels Input/Output and Digital LDO (DLDO) Supply from 1.8 V to 3.6 V. IOVDD must not be lower than DREGCAP.
25	DOUT3	Digital output	I/O	Data Output Pin 3. If the device is configured in daisy-chain mode, this pin acts as an input pin. See the Daisy-Chain Mode section for more details.
26	DOUT2	Digital output	I/O	Data Output Pin 2. If the device is configured in daisy-chain mode, this pin acts as an input pin. See the Daisy-Chain Mode section for more details.
27	DOUT1	Digital output	Output	Data Output Pin 1.
28	DOUT0	Digital output	Output	Data Output Pin 0.
29	DCLK	Digital output	Output	Data Output Clock.
30	$\overline{DRDY}$	Digital output	Output	Data Output Ready Pin.
31	XTAL1	Clock	Input	Crystal 1 Input Connection. If CMOS is used as a clock source, tie this pin to DGND. See Table 12 for more details.
32	XTAL2/MCLK	Clock	Input	Crystal 2 Input Connection (XTAL2). See Table 12 for more details. CMOS Clock (MCLK). See Table 12 for more details.
33	$\overline{START}$	Digital input	Input	Synchronization Pulse. This pin internally synchronizes an external $\overline{START}$ asynchronous pulse with MCLK. The synchronize signal is shifted out by the $\overline{SYNC\_OUT}$ pin. If not in use, tie this pin to IOVDD. See the Phase Adjustment section and the Digital Reset and Synchronization Pins section for more details.
34	$\overline{SYNC\_OUT}$	Digital output	Input	Synchronization Signal. This pin generates a synchronous pulse generated and driven by hardware (via the $\overline{START}$ pin) or by software (GENERAL_USER_CONFIG_2, Bit 0). If this pin is in use, it must be wired to the $\overline{SYNC\_IN}$ pin. See the Phase Adjustment section and the Digital Reset and Synchronization Pins section for more details.
35	$\overline{SYNC\_IN}$	Digital input	Input	Reset for the Internal Digital Block and Synchronize for Multiple Devices. See the Digital Reset and Synchronization Pins section for more details.
36	$\overline{RESET}$	Digital input	Input	Asynchronous Reset Pin. This pin resets all registers to their default value. It is recommended to generate a pulse on this pin after the device is powered up because a slow slew rate in the supplies may generate an incorrect initialization in the digital block.
37	AIN7+	Analog input	Input	Analog Input Channel 7, Positive.
38	AIN7-	Analog input	Input	Analog Input Channel 7, Negative.
39	AIN6+	Analog input	Input	Analog Input Channel 6, Positive.
40	AIN6-	Analog input	Input	Analog Input Channel 6, Negative.
41	REF2+	Reference	Input	Positive Reference Input 2 for Channel 4 to Channel 7, Typical at REF2- + 2.5 V.

Pin No.	Mnemonic	Type	Direction	Description
42	REF2-	Reference	Input	Negative Reference Input 2 for Channel 4 to Channel 7, Typical at AVSSx. Connect all the REFx- pins to the same potential.
43	AVDD1B	Supply	Supply	Positive Front-End Analog Supply for Channel 4 to Channel 7. Connect this pin to AVDD1A.
44	AVSS1B	Supply	Supply	Negative Front-End Analog Supply for Channel 4 to Channel 7, typical at -1.65 V (Dual Supply) or AGND (Single Supply). Connect all the AVSSx pins to the same potential.
45	AIN5+	Analog input	Input	Analog Input Channel 5, Positive.
46	AIN5-	Analog input	Input	Analog Input Channel 5, Negative.
47	AIN4+	Analog input	Input	Analog Input Channel 4, Positive.
48	AIN4-	Analog input	Input	Analog Input Channel 4, Negative.
49	REF_OUT	Reference	Output	2.5 V Reference Output. Connect a 100 nF capacitor on this pin if using the internal reference.
50	AVSS2B	Supply	Supply	Negative Analog Supply. Connect all the AVSSx pins to the same potential.
51	AREG2CAP	Supply	Output	Analog LDO Output 2. Decouple this pin to AVSS2B with a 1 $\mu$ F capacitor.
52	AVDD2B	Supply	Supply	Positive Analog Supply. Connect this pin to AVDD2A.
53	AVSS3	Supply	Supply	Negative Analog Ground. Connect all the AVSSx pins to the same potential.
54	FORMAT1	Digital input	Input	Output Data Frame 1. See Table 13 for more details.
55	FORMAT0	Digital input	Input	Output Data Frame 0. See Table 13 for more details.
56	CLK_SEL	Digital input	Input	Select Clock Source. See Table 12 for more details.
57	VCM	Analog output	Output	Common-Mode Voltage Output, Typical at (AVDD1 + AVSSx)/2.
58	AVDD2A	Supply	Input	Analog Supply from 2.2V to 3.6V. AVSS2x must not be lower than AREGxCAP. Connect this pin to AVDD2B.
59	AREG1CAP	Supply	Output	Analog LDO Output 1. Decouple this pin to AVSSx with a 1 $\mu$ F capacitor.
60	AVSS2A	Supply	Input	Negative Analog supply. Connect all the AVSSx pins to the same potential.
61	AVSS4	Supply	Supply	Negative SAR Analog Supply and Reference. Connect all AVSSx pins to the same potential.
62	AVDD4	Supply	Supply	Positive SAR Analog Supply and Reference Source.
63	AUXAIN+	Analog input	Input	Positive SAR Analog Input Channel.
64	AUXAIN-	Analog input	Input	Negative SAR Analog Input Channel.
	EPAD	Supply	Input	Exposed Pad. Connect the exposed pad to AVSSx.

TYPICAL PERFORMANCE CHARACTERISTICS

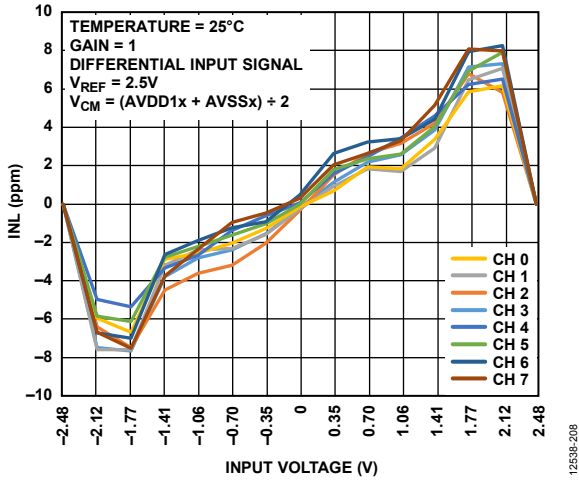

Figure 8. INL vs. Input Voltage and Channel at 16 kSPS, High Resolution Mode

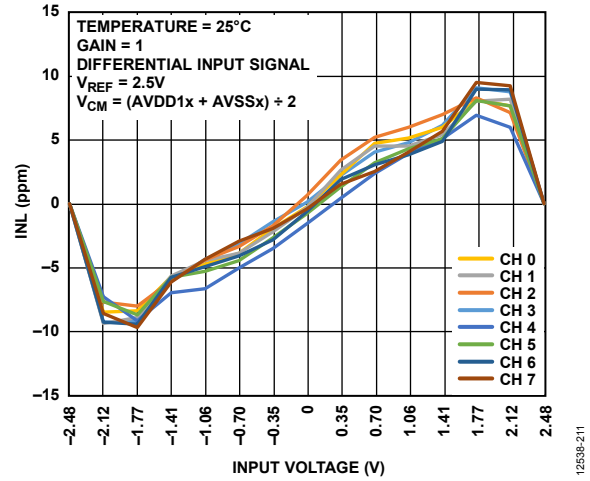

Figure 11. INL vs. Input Voltage and Channel at 4 kSPS, Low Power Mode

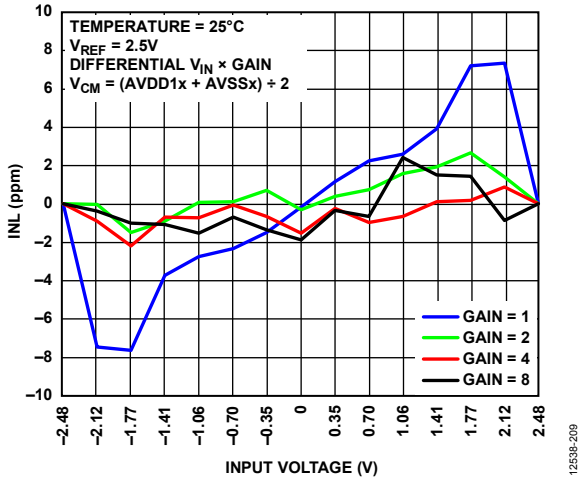

Figure 9. INL vs. Input Voltage and PGA Gain at 16 kSPS, High Resolution Mode

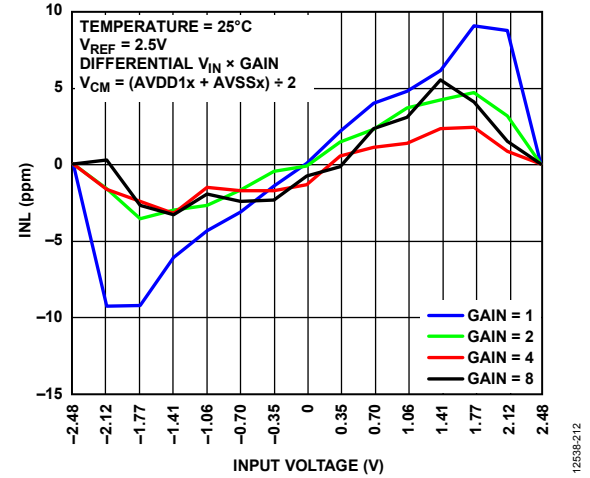

Figure 12. INL vs. Input Voltage and PGA Gain at 4 kSPS, Low Power Mode

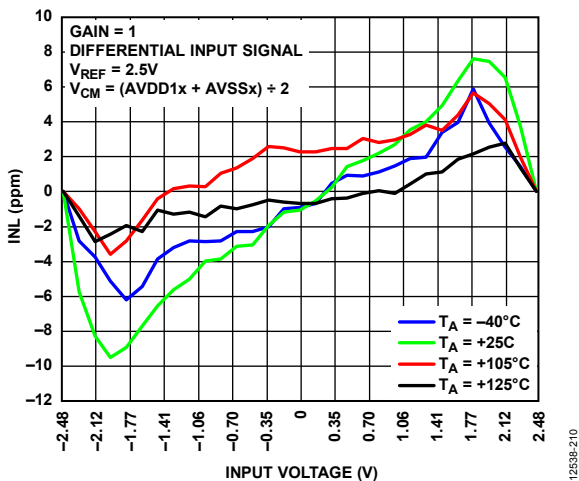

Figure 10. INL vs. Input Voltage and Temperature at 16 kSPS, High Resolution Mode

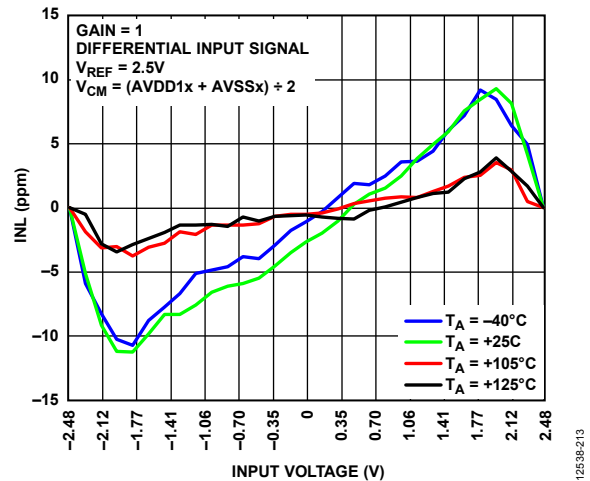

Figure 13. INL vs. Input Voltage and Temperature at 4 kSPS, Low Power Mode

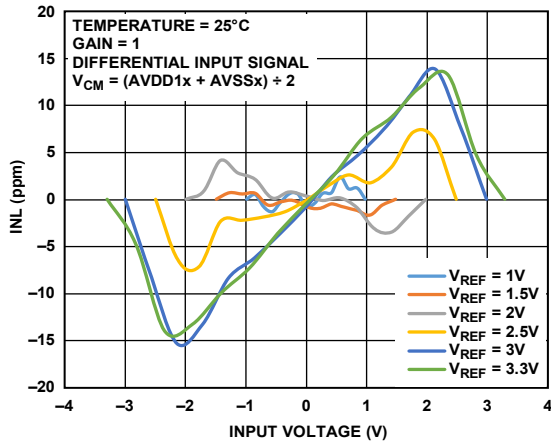

Figure 14. INL vs. Input Voltage and Reference Voltage ( $V_{REF}$ ) at 16 kSPS, High Resolution Mode

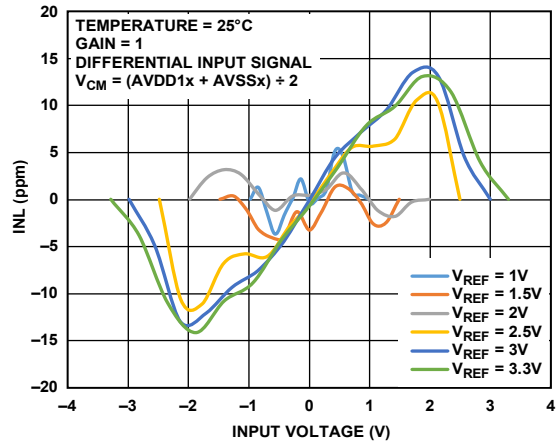

Figure 17. INL vs. Input Voltage and  $V_{REF}$  at 4 kSPS, Low Power Mode

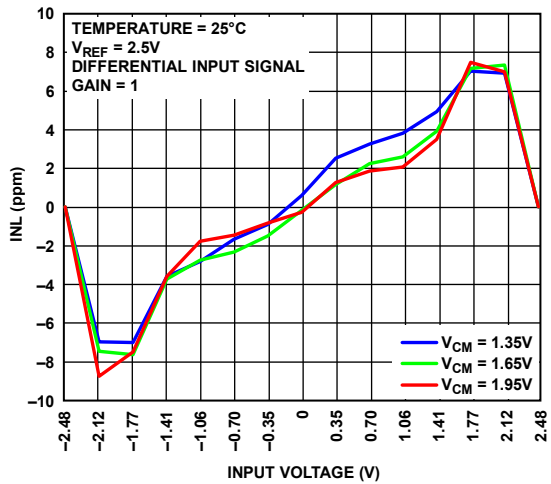

Figure 15. INL vs. Input Voltage and  $V_{CM}$  at 16 kSPS, High Resolution Mode

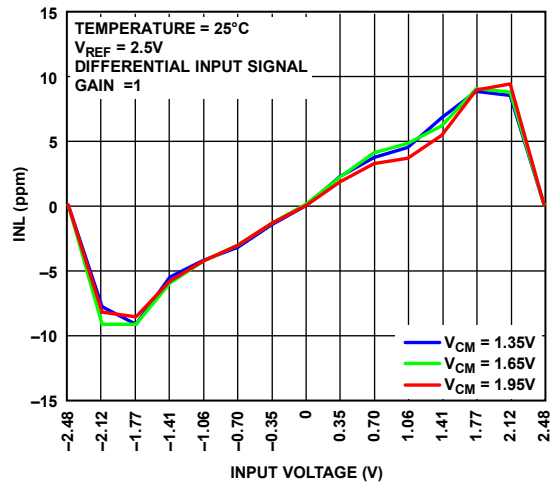

Figure 18. INL vs. Input Voltage and  $V_{CM}$  at 4 kSPS, Low Power Mode

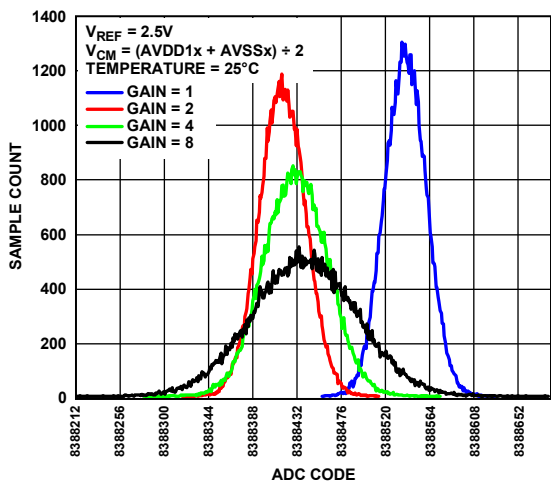

Figure 16. Noise Histogram at 16 kSPS, High Resolution Mode

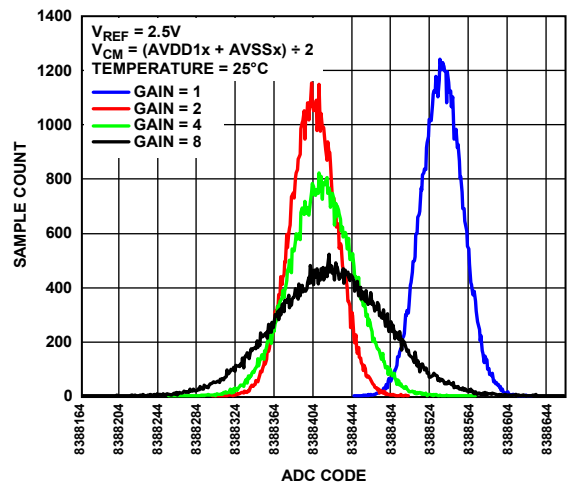

Figure 19. Noise Histogram at 4 kSPS, Low Power Mode

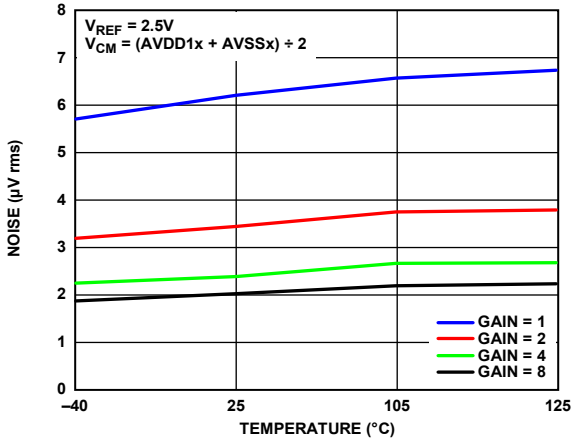

Figure 20. Noise vs. Temperature at 16 kSPS, High Resolution Mode

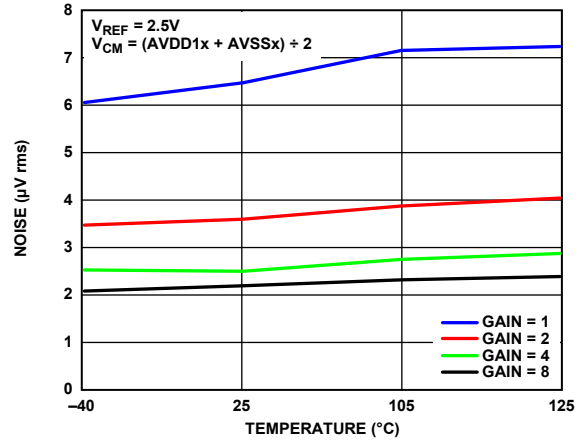

Figure 23. Noise vs. Temperature at 4 kSPS, Low Power Mode

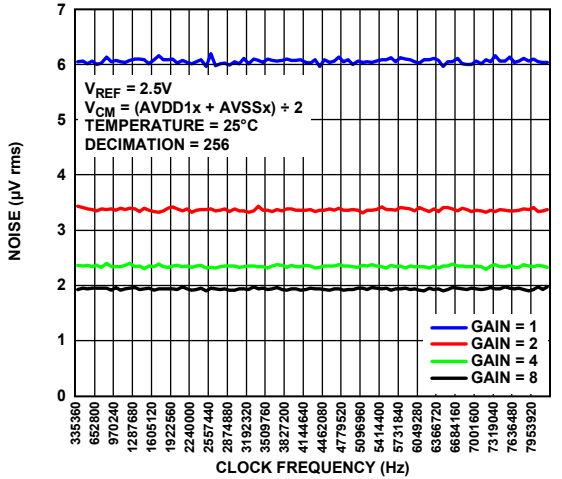

Figure 21. Noise vs. Clock Frequency, High Resolution Mode

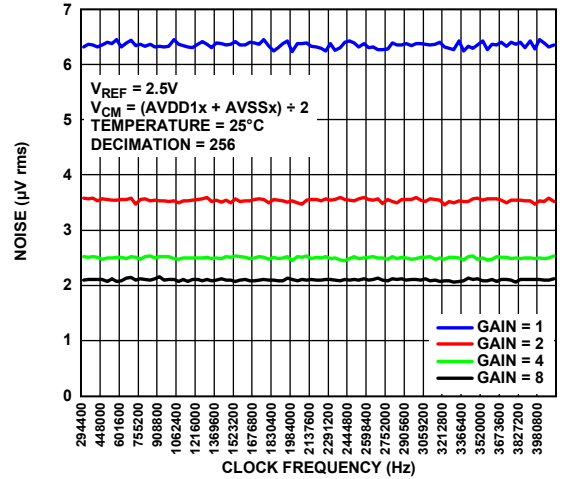

Figure 24. Noise vs. Clock Frequency, Low Power Mode

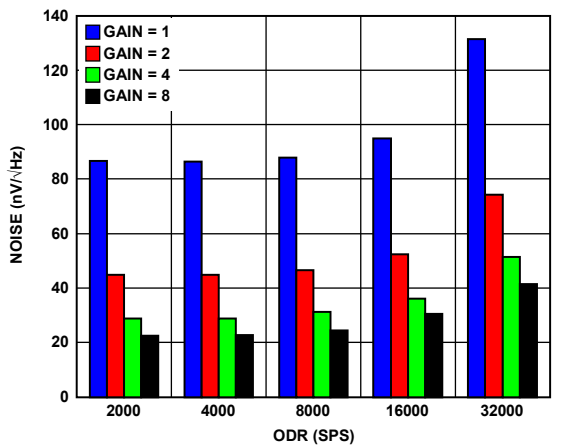

Figure 22. Noise vs. ODR, High Resolution Mode

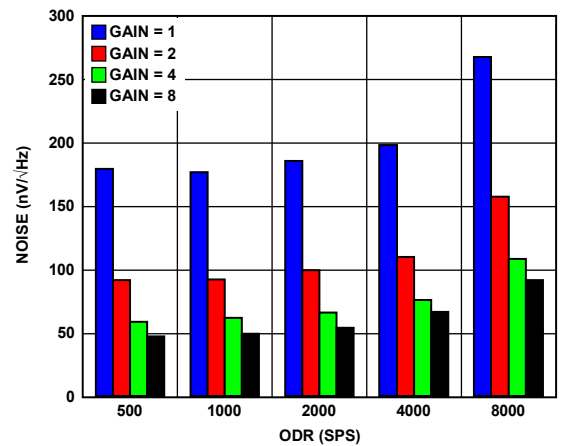

Figure 25. Noise vs. ODR, Low Power Mode

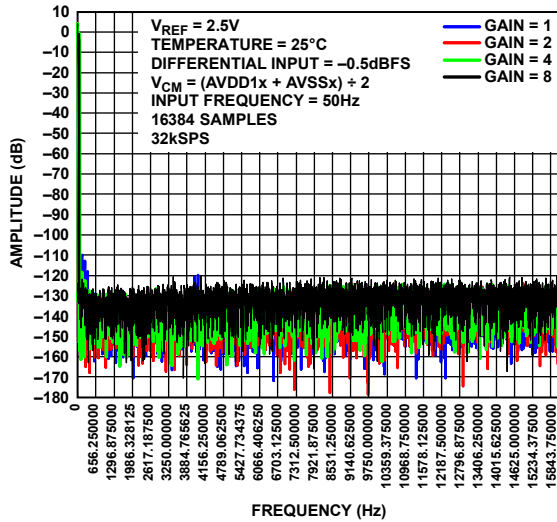

Figure 26. FFT at 32 kSPS, High Resolution Mode, Input Frequency ( $f_{IN}$ ) = 50 Hz

12538-226

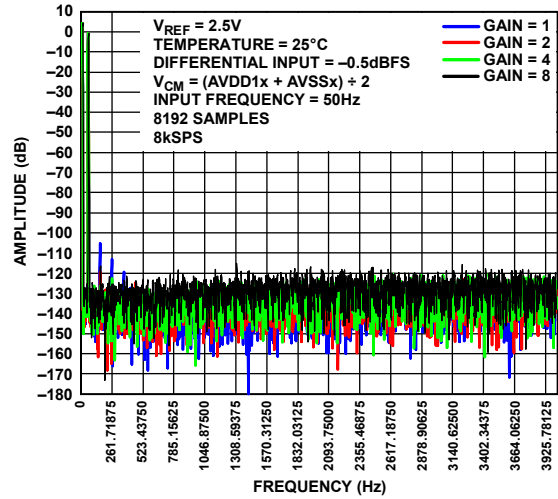

Figure 29. FFT at 8 kSPS, Low Power Mode, Input Frequency ( $f_{IN}$ ) = 50 Hz

12538-229

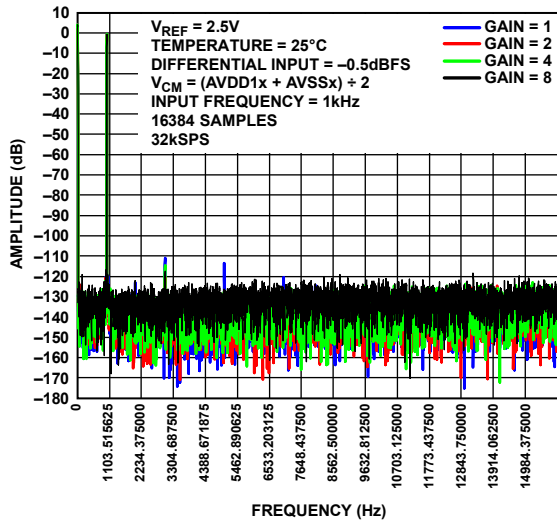

Figure 27. FFT at 32 kSPS, High Resolution Mode, Input Frequency ( $f_{IN}$ ) = 1 kHz

12538-227

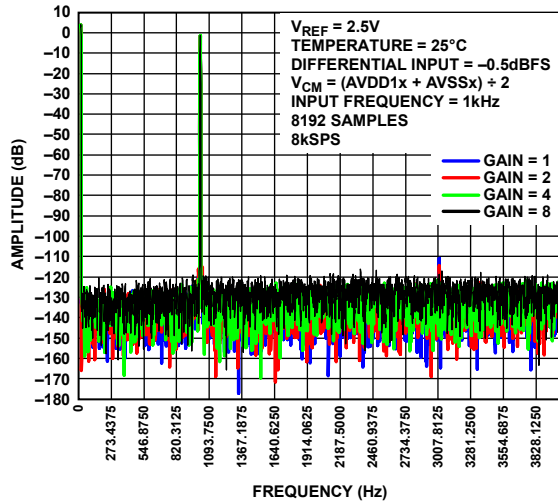

Figure 30. FFT at 8 kSPS, Low Power Mode, Input Frequency ( $f_{IN}$ ) = 1 kHz

12538-230

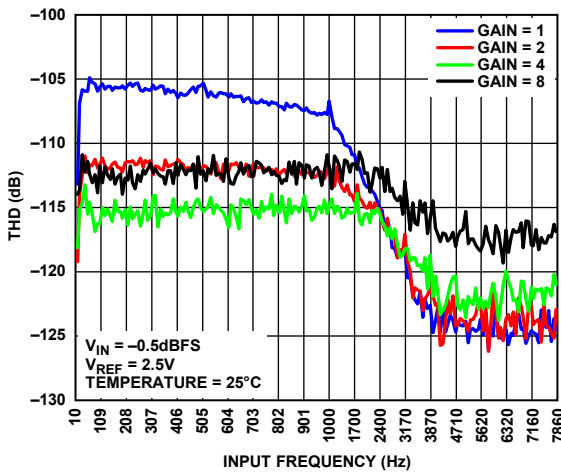

Figure 28. THD vs. Input Frequency at 16 kSPS, High Resolution Mode

12538-228

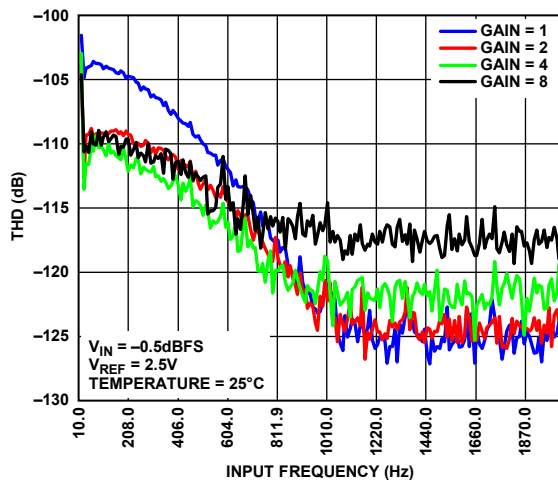

Figure 31. THD vs. Input Frequency at 4 kSPS, Low Power Mode

12538-231

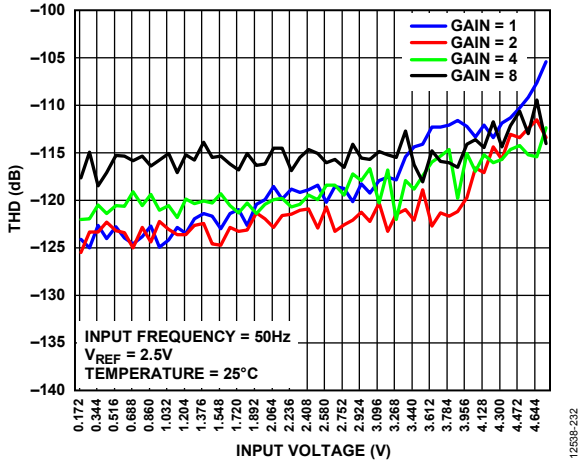

Figure 32. THD vs. Input Voltage at 16 kSPS, High Resolution Mode

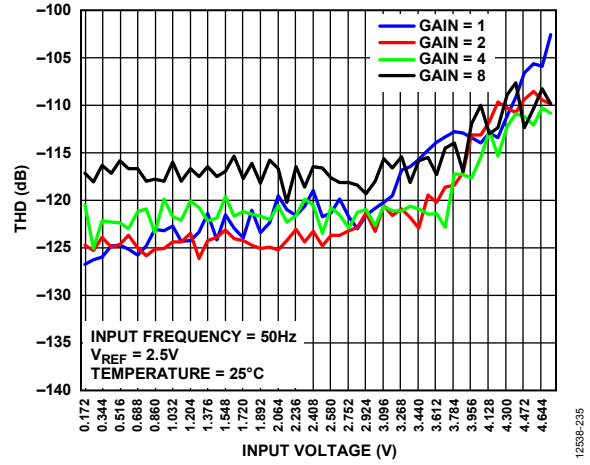

Figure 35. THD vs. Input Voltage at 4 kSPS, Low Power Mode

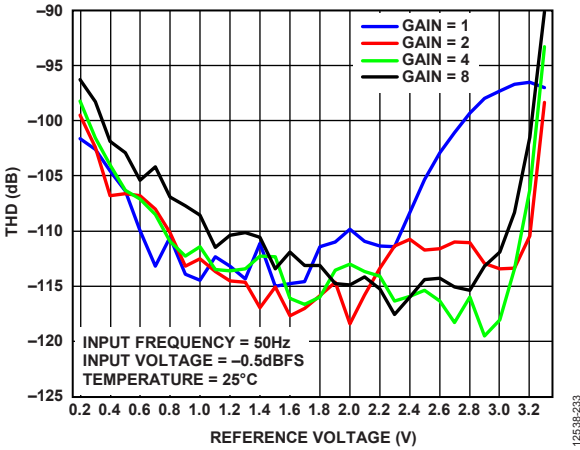

Figure 33. THD vs. Reference Voltage at 16 kSPS, High Resolution Mode

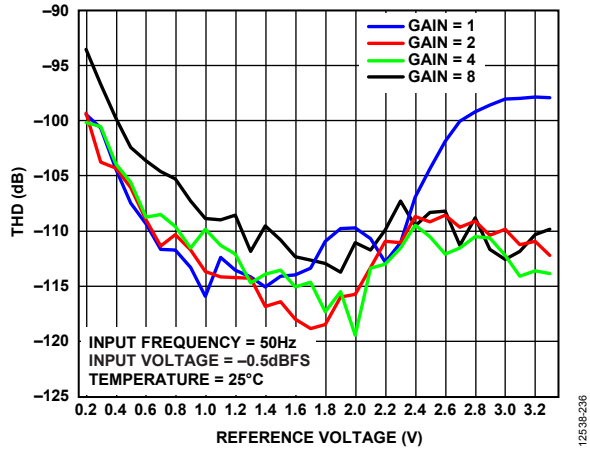

Figure 36. THD vs. Reference Voltage at 4 kSPS, Low Power Mode

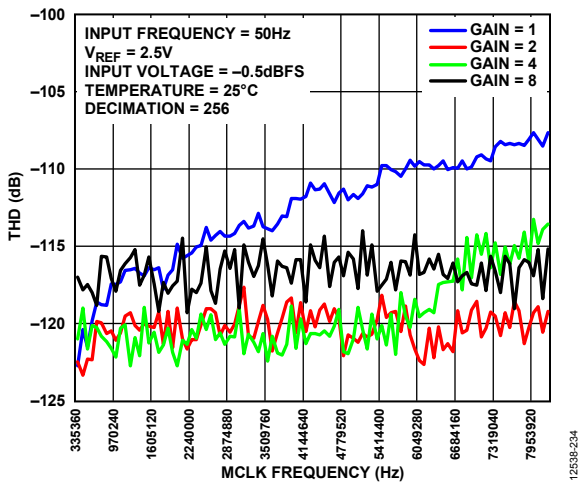

Figure 34. THD vs. MCLK Frequency, High Resolution Mode

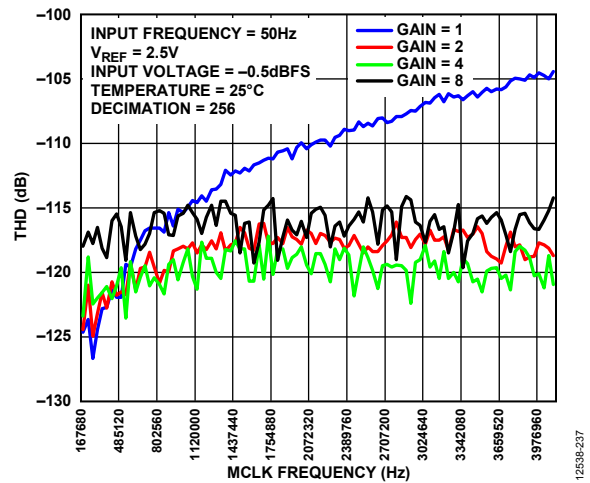

Figure 37. THD vs. MCLK Frequency, Low Power Mode

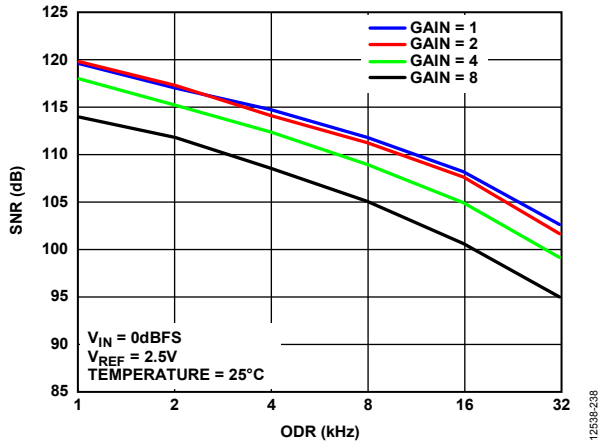

Figure 38. SNR vs. ODR at 16 kSPS, High Resolution Mode

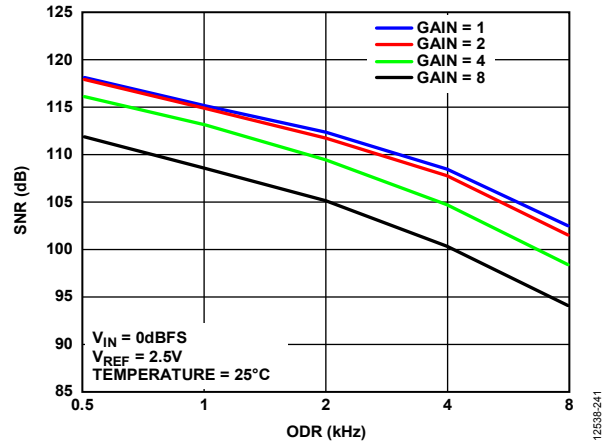

Figure 41. SNR vs. ODR at 4 kSPS, Low Power Mode

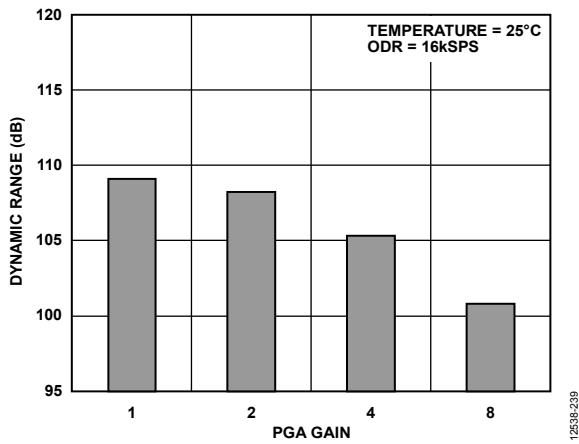

Figure 39. Dynamic Range vs. PGA Gain, High Resolution Mode

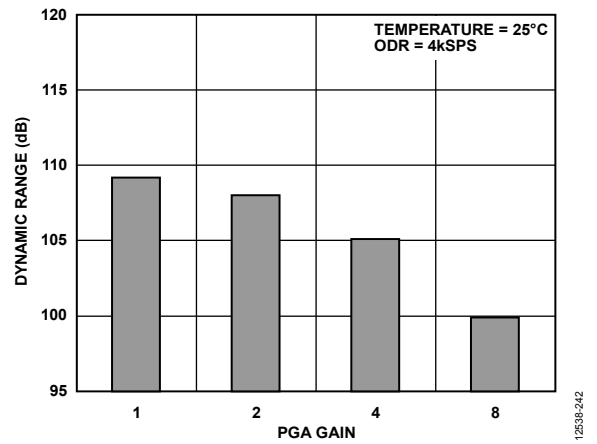

Figure 42. Dynamic Range vs. PGA Gain, Low Power Mode

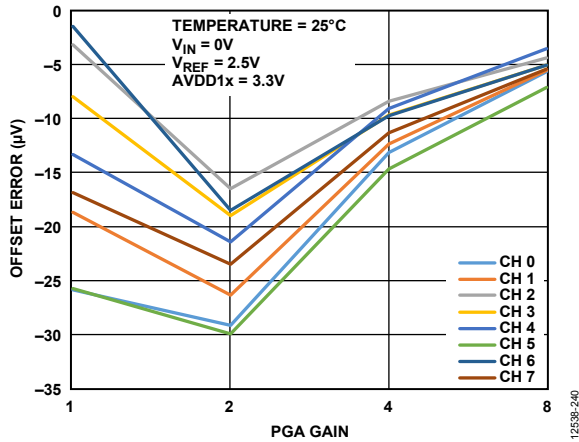

Figure 40. Offset Error vs. PGA Gain, High Resolution Mode

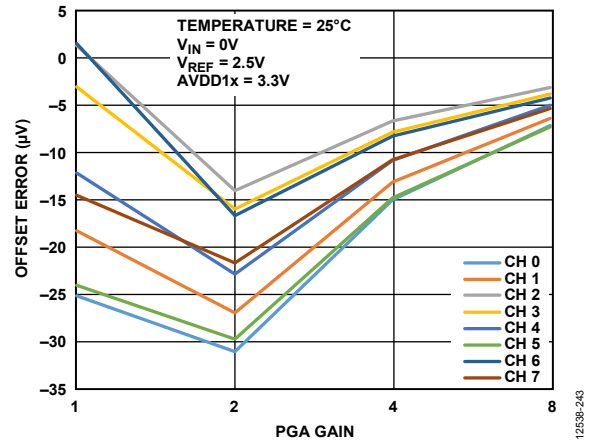

Figure 43. Offset Error vs. PGA Gain, Low Power Mode



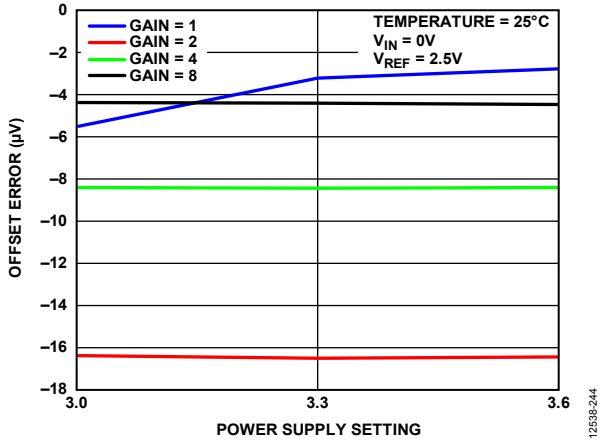

Figure 44. Offset Error vs. Power Supply Setting, High Resolution Mode

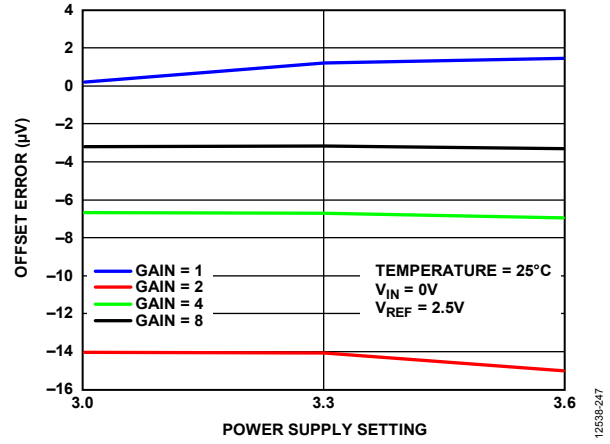

Figure 47. Offset Error vs. Power Supply Setting, Low Power Mode

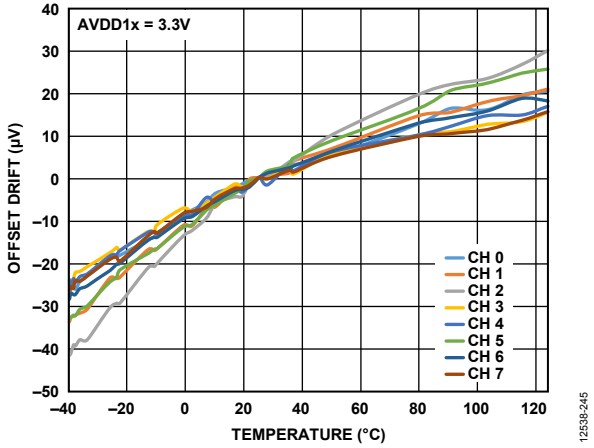

Figure 45. Offset Drift vs. Temperature

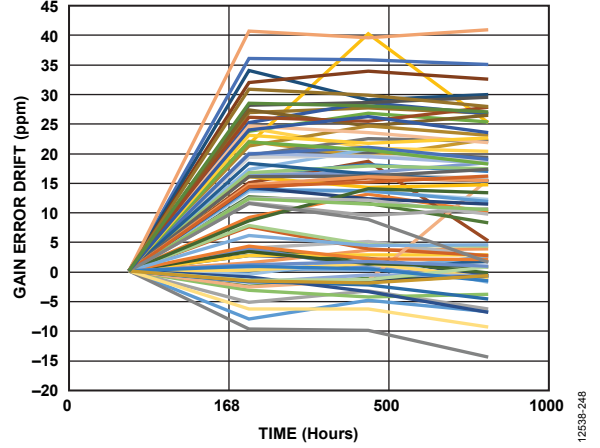

Figure 48. Gain Error Drift vs. Time

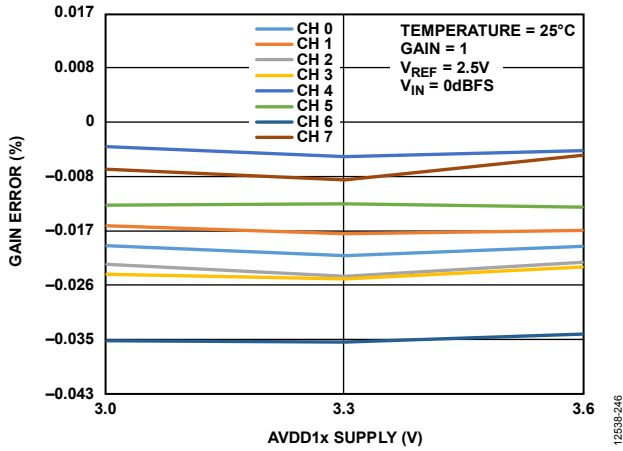

Figure 46. Gain Error vs. AVDD1x Supply, High Resolution Mode

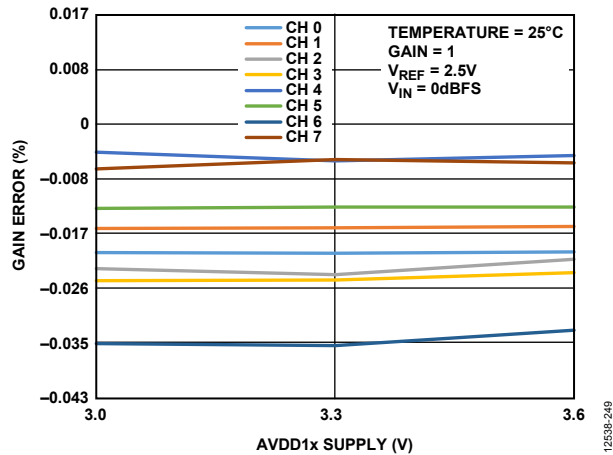

Figure 49. Gain Error vs. AVDD1x Supply, Low Power Mode

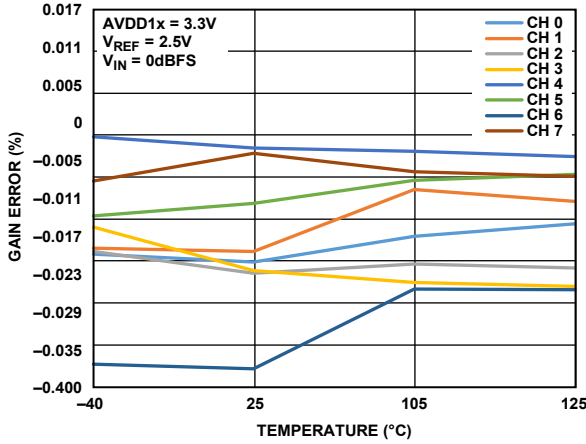

Figure 50. Gain Error vs. Temperature, High Resolution Mode

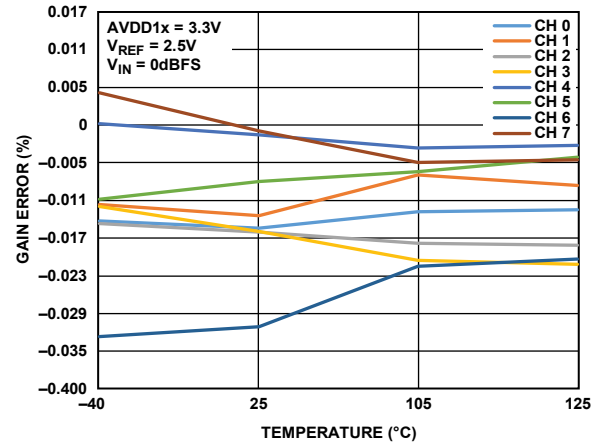

Figure 53. Gain Error vs. Temperature, Low Power Mode

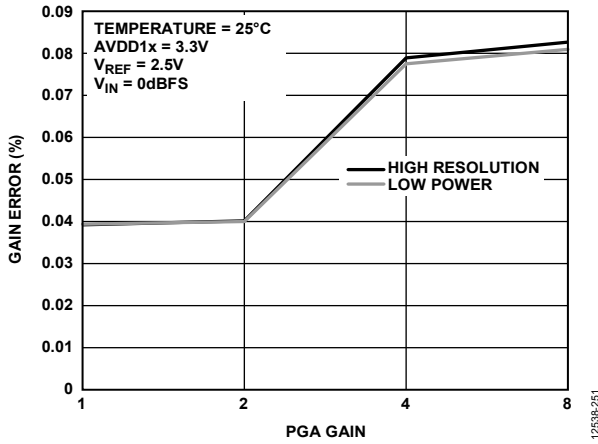

Figure 51. Channel Gain Mismatch, High Resolution Mode

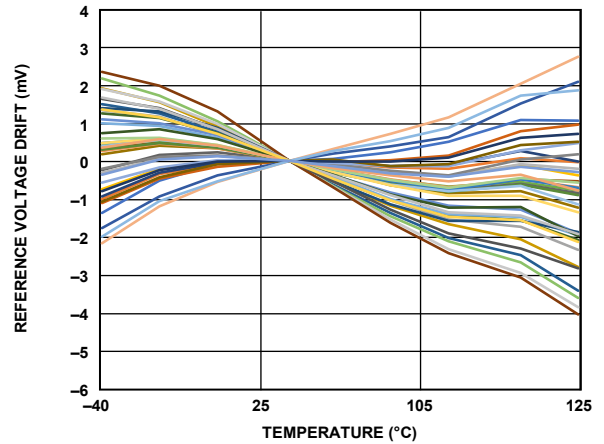

Figure 54. Internal Reference Voltage Drift

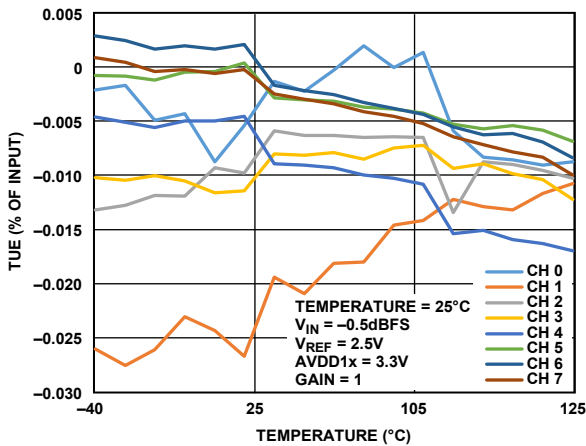

Figure 52. Total Unadjusted Error (TUE) vs. Temperature, High Resolution Mode

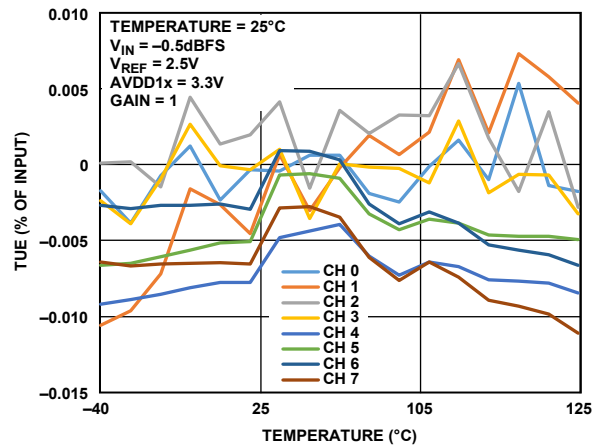

Figure 55. Total Unadjusted Error (TUE) vs. Temperature, Low Power Mode

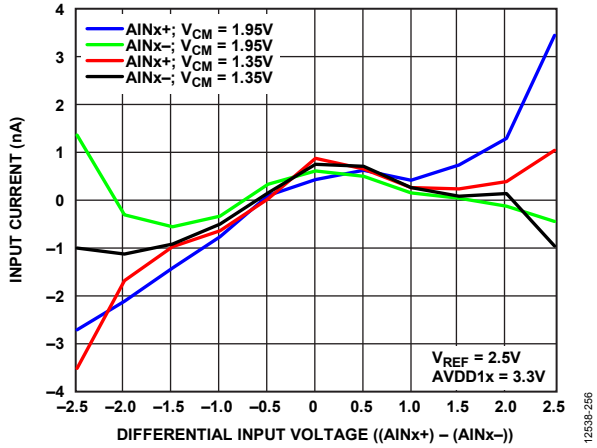

Figure 56. Input Current vs. Differential Input Voltage, High Resolution Mode

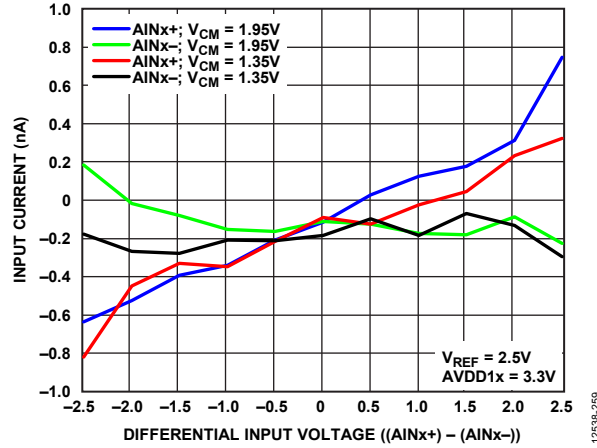

Figure 59. Input Current vs. Differential Input Voltage, Low Power Mode

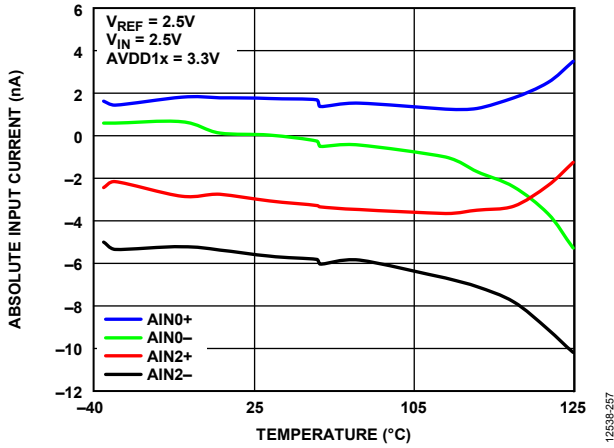

Figure 57. Absolute Input Current vs. Temperature, High Resolution Mode

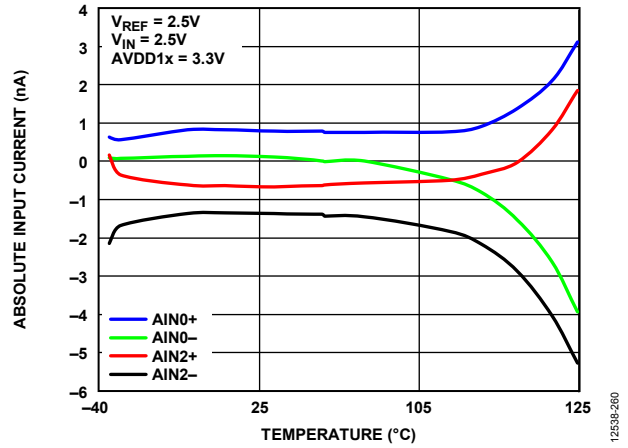

Figure 60. Absolute Input Current vs. Temperature, Low Power Mode

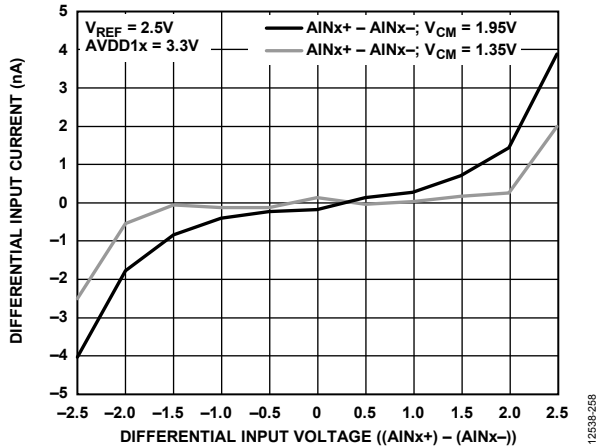

Figure 58. Differential Input Current vs. Differential Input Voltage, High Resolution Mode

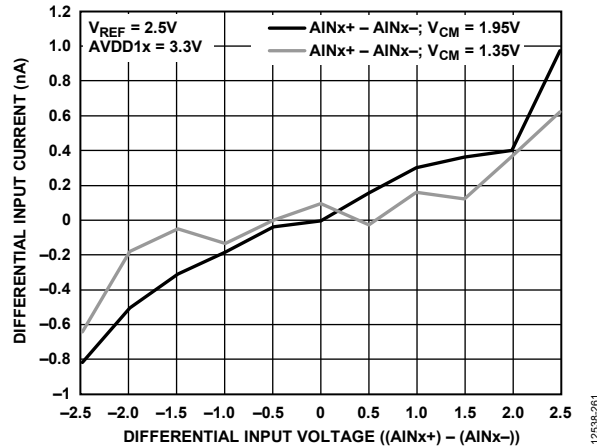

Figure 61. Differential Input Current vs. Differential Input Voltage, Low Power Mode

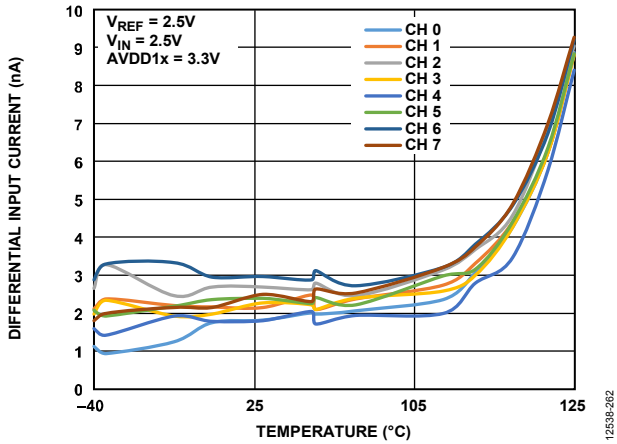

Figure 62. Differential Input Current vs. Temperature, High Resolution Mode

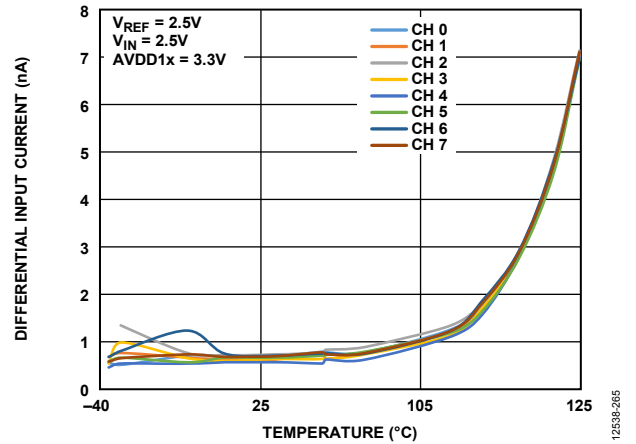

Figure 65. Differential Input Current vs. Temperature, Low Power Mode

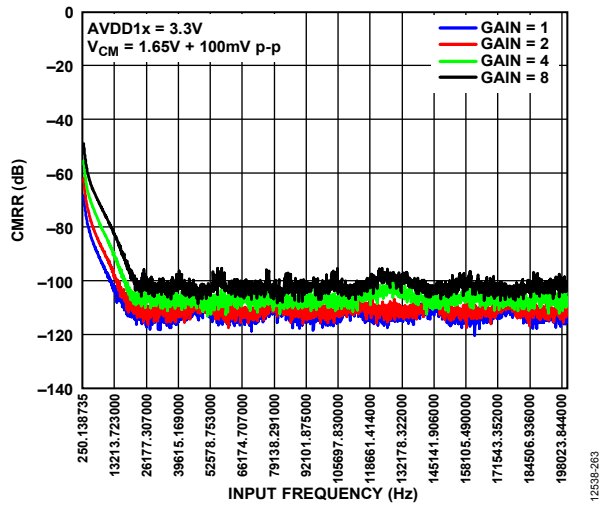

Figure 63. Common-Mode Rejection Ratio (CMRR) vs. Input Frequency at 16 kSPS, High Resolution Mode

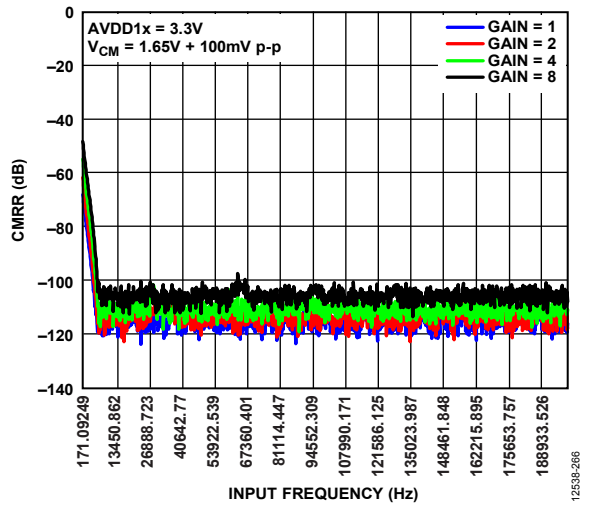

Figure 66. CMRR vs. Input Frequency at 4 kSPS, Low Power Mode

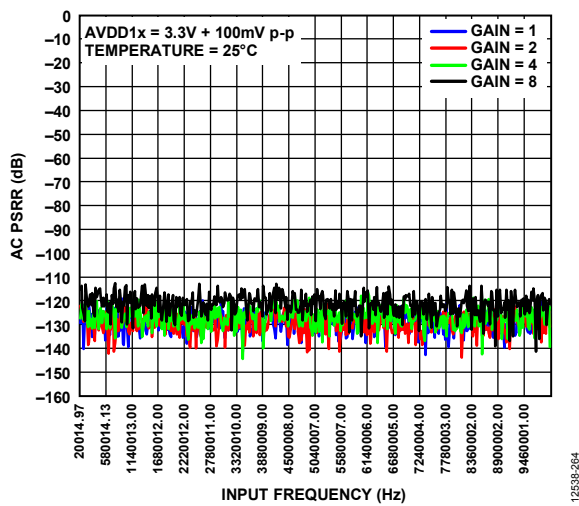

Figure 64. AC Power Supply Rejection Ratio (PSRR) vs. Input Frequency at 16 kSPS, High Resolution Mode

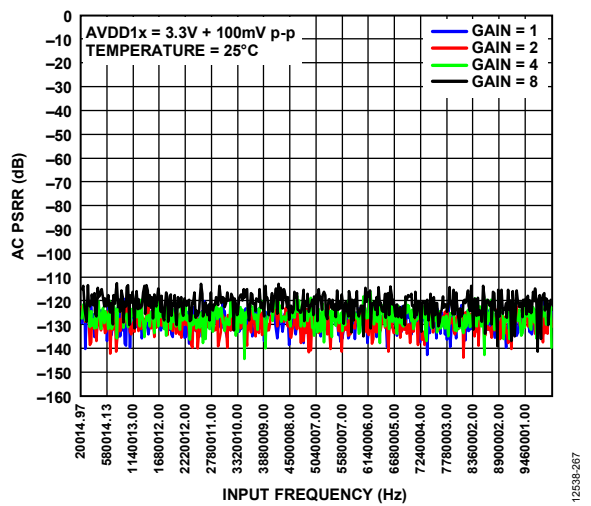

Figure 67. AC PSRR vs. Input Frequency at 4 kSPS, Low Power Mode

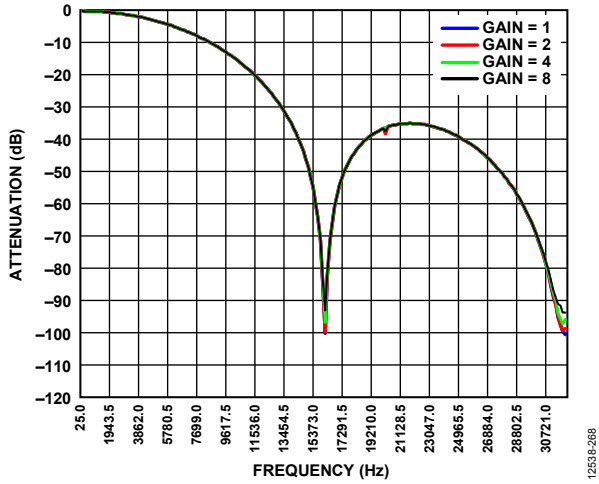

Figure 68. Filter Profiles at 16 kSPS, High Resolution Mode

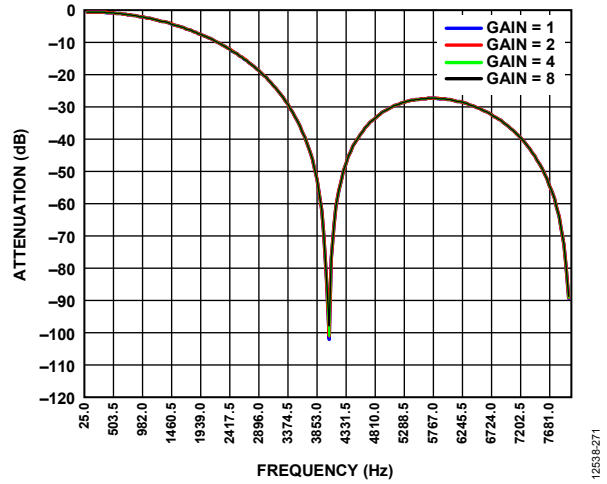

Figure 71. Filter Profiles at 4 kSPS, Low Power Mode

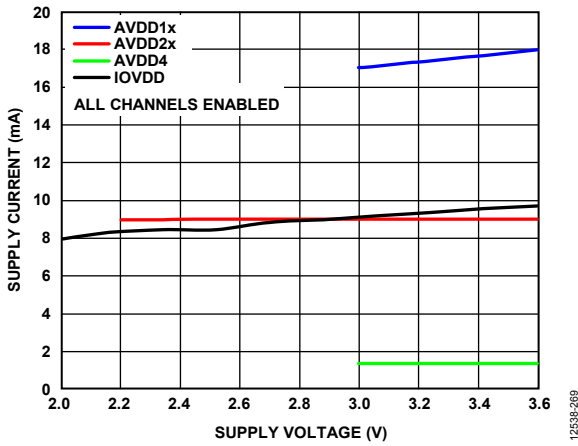

Figure 69. Supply Current vs. Supply Voltage, High Resolution Mode

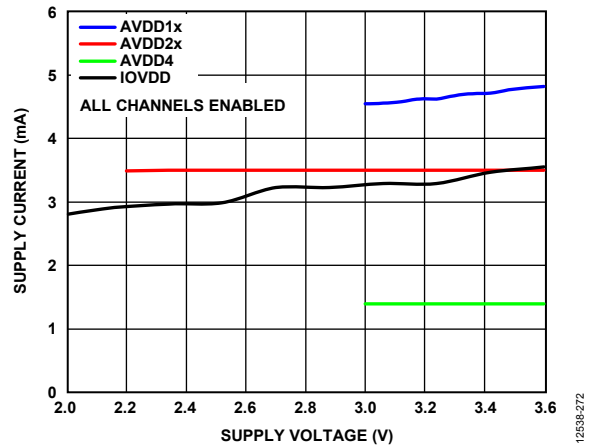

Figure 72. Supply Current vs. Supply Voltage, Low Power Mode

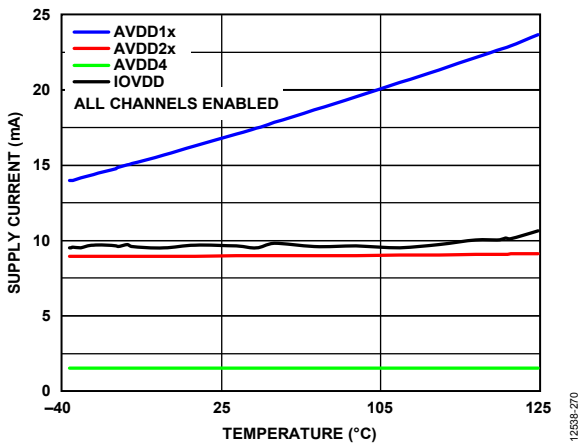

Figure 70. Supply Current vs. Temperature, High Resolution Mode

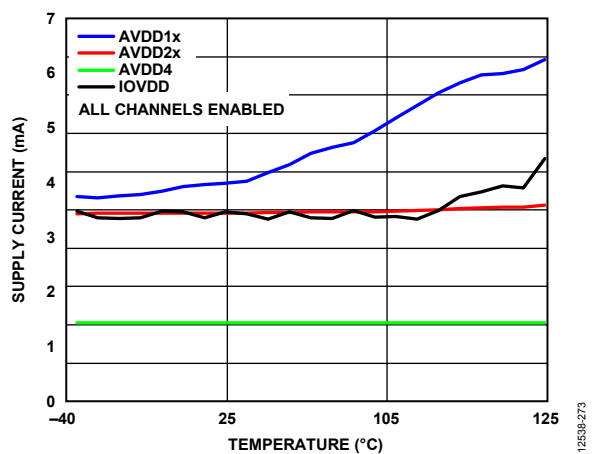

Figure 73. Supply Current vs. Temperature, Low Power Mode

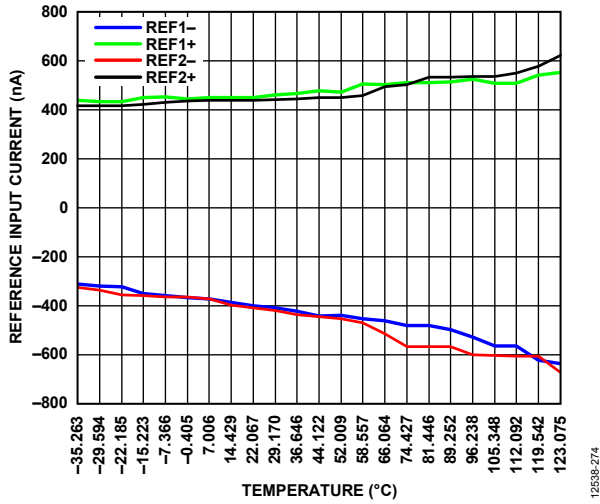

Figure 74. Reference Input Current vs. Temperature, High Resolution Mode

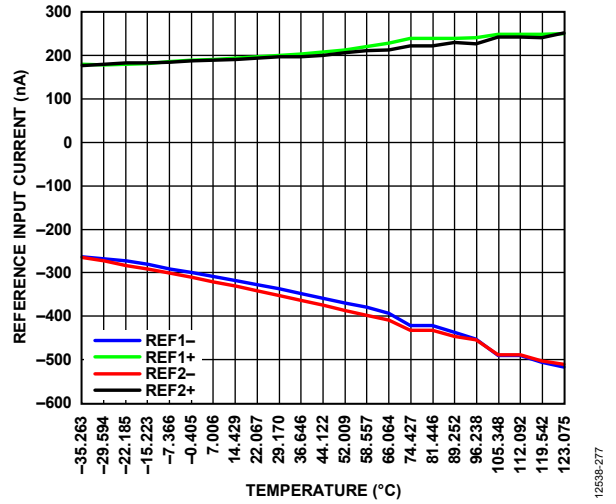

Figure 77. Reference Input Current vs. Temperature, Low Power Mode

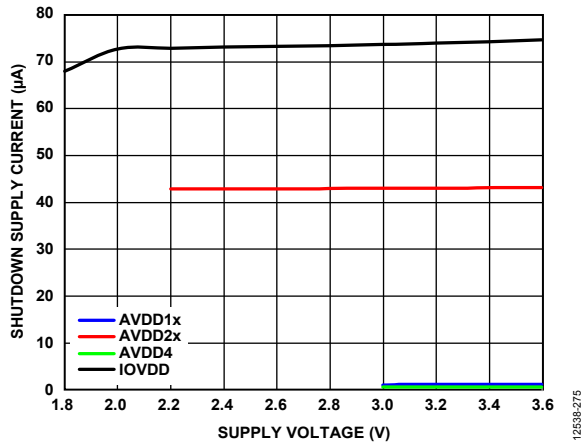

Figure 75. Shutdown Supply Current vs. Supply Voltage

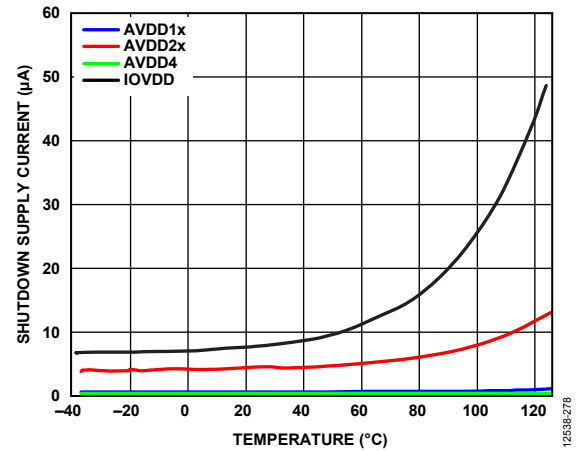

Figure 78. Shutdown Supply Current vs. Temperature

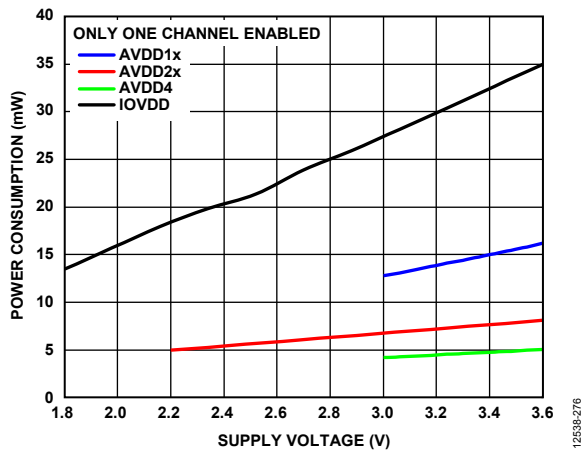

Figure 76. Power Consumption per Channel vs. Supply Voltage, High Resolution Mode

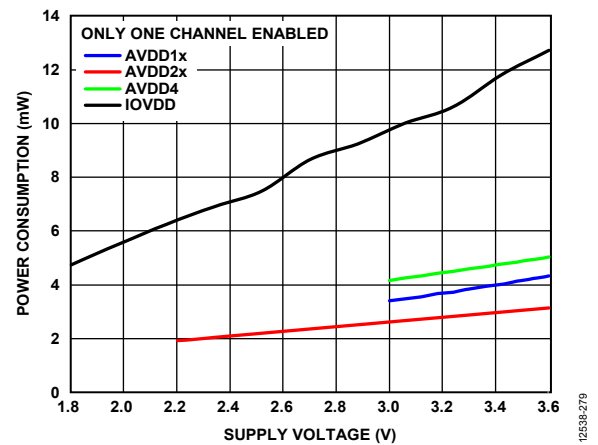

Figure 79. Power Consumption per Channel vs. Supply Voltage, Low Power Mode

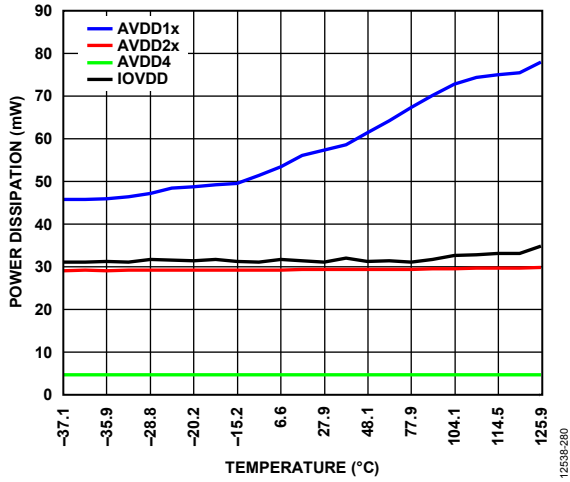

Figure 80. Power Dissipation vs. Temperature, High Resolution Mode

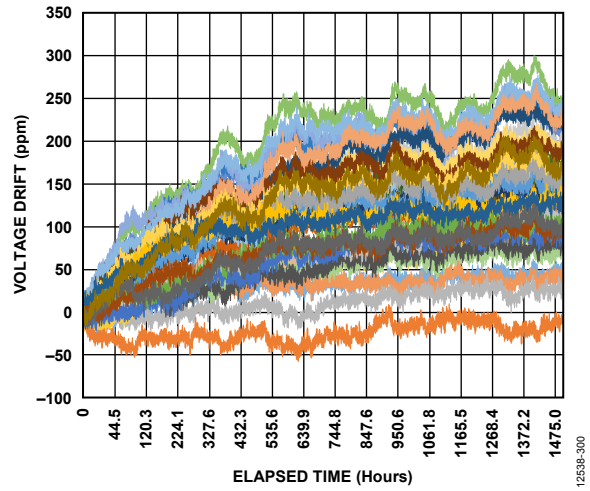

Figure 82. Internal Reference Long Term Drift from 0 Hours to 1500 Hours

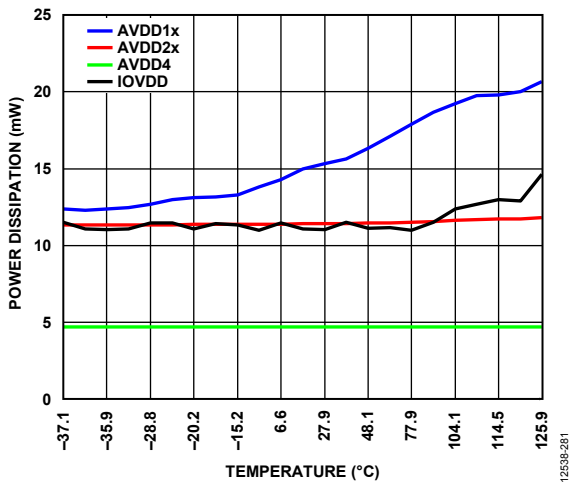

Figure 81. Power Dissipation vs. Temperature, Low Power Mode

## TERMINOLOGY

### Common-Mode Rejection Ratio (CMRR)

CMRR is the ratio of the power in the ADC output at full-scale frequency,  $f$ , to the power of a 100 mV p-p sine wave applied to the common-mode voltage of AINx+ and AINx- at frequency,  $f_s$ .

$$CMRR \text{ (dB)} = 10 \log(P_f/P_{f_s})$$

where:

$P_f$  is the power at frequency,  $f$ , in the ADC output.

$P_{f_s}$  is the power at frequency,  $f_s$ , in the ADC output.

### Differential Nonlinearity (DNL) Error

In an ideal ADC, code transitions are 1 LSB apart. Differential nonlinearity is the maximum deviation from this ideal value. DNL error is often specified in terms of resolution for which no missing codes are guaranteed.

### Integral Nonlinearity (INL) Error

Integral nonlinearity error refers to the deviation of each individual code from a line drawn from negative full scale through positive full scale. The point used as negative full scale occurs ½ LSB before the first code transition. Positive full scale is a level 1½ LSB beyond the last code transition. The deviation is measured from the middle of each code to the true straight line.

### Dynamic Range

Dynamic range is the ratio of the rms value of the full-scale input signal to the rms noise measured for an input. The value for dynamic range is expressed in decibels.

### Channel to Channel Isolation

Channel to channel isolation is a measure of the level of crosstalk between channels. It is measured by applying a full-scale frequency sweep sine wave signal to all seven unselected input channels and determining how much that signal is attenuated in the selected channel. The value is given for worst case scenarios across all eight channels of the AD7770.

### Intermodulation Distortion

With inputs consisting of sine waves at two frequencies,  $f_A$  and  $f_B$ , any active device with nonlinearities creates distortion products at sum and difference frequencies of  $mf_A$  and  $nf_B$ , where  $m, n = 0, 1, 2, 3$ , and so on. Intermodulation distortion terms are those for which neither  $m$  nor  $n$  is equal to 0. For example, the second-order terms include  $(f_A + f_B)$  and  $(f_A - f_B)$  and the third-order terms include  $(2f_A + f_B)$ ,  $(2f_A - f_B)$ ,  $(f_A + 2f_B)$ , and  $(f_A - 2f_B)$ . The AD7770 is tested using the CCIF standard, where two input frequencies near the top end of the input bandwidth are used. In this case, the second-order terms are usually distanced in frequency from the original sine waves, and the third-order terms are usually at a frequency close to the input frequencies. As a result, the second-order and third-order terms are specified separately.

The calculation of the intermodulation distortion is per the THD specification, where it is the ratio of the rms sum of the individual distortion products to the rms amplitude of the sum of the fundamentals, expressed in decibels.

### Gain Error

The first transition (from 100 ... 000 to 100 ... 001) occurs at a level ½ LSB above nominal negative full scale ( $-2.49999$  V for the  $\pm 2.5$  V range). The last transition (from 011 ... 110 to 011 ... 111) occurs for an analog voltage 1½ LSB below the nominal full scale ( $2.49999$  V for the  $\pm 2.5$  V range). The gain error is the deviation of the difference between the actual level of the last transition and the actual level of the first transition from the difference between the ideal levels.

### Gain Error Drift

Gain error drift is the ratio of the gain error change due to a temperature change of 1°C and the full-scale range ( $2^N$ ). It is expressed in parts per million.

### Least Significant Bit (LSB)

The least significant bit, or LSB, is the smallest increment that can be represented by a converter. For a fully differential input ADC with  $N$  bits of resolution, the LSB expressed in volts is

$$LSB \text{ (V)} = \frac{2 \times V_{REF}}{2^N}$$

The LSB referred to the input is

$$LSB \text{ (V}_{IN}) = \frac{2 \times V_{REF}}{PGA_{GAIN} \times 2^N}$$

### Power Supply Rejection Ratio (PSRR)

Variations in power supply affect the full-scale transition but not the linearity of the converter. PSRR is the maximum change in the full-scale transition point due to a change in the power supply voltage from the nominal value.

### Signal-to-Noise Ratio (SNR)

SNR is the ratio of the rms value of the actual input signal to the rms sum of all other spectral components below the Nyquist frequency, excluding harmonics and dc. The value for SNR is expressed in decibels.

### Signal-to-(Noise + Distortion) Ratio (SINAD)

SINAD is the ratio of the rms value of the actual input signal to the rms sum of all other spectral components below the Nyquist frequency, including harmonics but excluding dc. The value for SINAD is expressed in decibels.

### Spurious-Free Dynamic Range (SFDR)

SFDR is the difference, in decibels, between the rms amplitude of the input signal and the peak spurious signal (including harmonics).

### Total Harmonic Distortion (THD)

THD is the ratio of the rms sum of the first five harmonic components to the rms value of a full-scale input signal and is expressed in decibels.

### Offset Error

Offset error is the difference between the ideal midscale input voltage (0 V) and the actual voltage producing the midscale output code.



**Offset Error Drift**

Offset error drift is the ratio of the offset error change due to a temperature change of 1°C and the full-scale code range ( $2^N$ ). It is expressed in  $\mu\text{V}/^\circ\text{C}$ .

## THEORY OF OPERATION

The AD7770 is an 8-channel, simultaneously sampling, low noise, 24-bit  $\Sigma$ - $\Delta$  ADC with integrated digital filtering per channel and SRC.

The AD7770 offers two operation modes: high resolution mode, which offers up to 32 kSPS, and low power mode, which offers up to 8 kSPS.

The AD7770 employs a  $\Sigma$ - $\Delta$  conversion technique to convert the analog input signal into an equivalent digital word. The overview of the  $\Sigma$ - $\Delta$  technique is that the modulator samples the input waveform and outputs an equivalent digital word at the input clock frequency,  $f_{CLKIN}$ .

Due to the high oversampling rate, this technique spreads the quantization noise from 0 Hz to  $f_{CLKIN}/2$  (in the case of the AD7770,  $f_{CLKIN}$  relates to the external clock); therefore, the noise energy contained in the band of interest is reduced (see Figure 83). To further reduce the quantization noise, a high order modulator is employed to shape the noise spectrum so that most of the noise energy is shifted out of the band of interest (see Figure 84). The digital filter that follows the modulator removes the large out of band quantization noise (see Figure 85).

For more information on basic and advanced concepts of  $\Sigma$ - $\Delta$  ADCs, see the [MT-022](#) Tutorial and [MT-023](#) Tutorial.

Digital filtering has certain advantages over analog filtering. Because digital filtering occurs after the analog-to-digital conversion process, it can remove noise injected during the conversion. Analog filtering cannot remove noise injected during conversion.

**Table 10. Input Signal Modes**

Input Signal Mode	PGA Gain	Maximum Differential Signal	Maximum Peak-to-Peak Signal
True differential	All gains	$\pm(V_{REF}/PGA_{GAIN})$	$2 \times V_{REF}/PGA_{GAIN}$
Pseudo differential	All gains	$\pm(V_{REF}/PGA_{GAIN})$	$2 \times V_{REF}/PGA_{GAIN}$
Single-ended	All gains	$V_{REF}/PGA_{GAIN}$	$V_{REF}/PGA_{GAIN}$

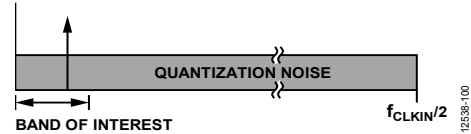

Figure 83.  $\Sigma$ - $\Delta$  ADC Operation, Reduction of Noise Energy Contained in the Band of Interest (Linear Scale X-Axis)

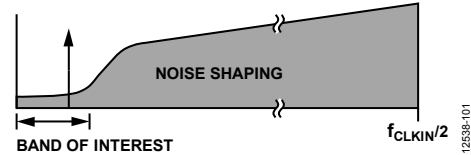

Figure 84.  $\Sigma$ - $\Delta$  ADC Operation, Majority of Noise Energy Shifted Out of the Band of Interest (Linear Scale X-Axis)

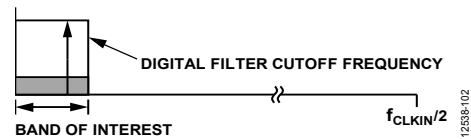

Figure 85.  $\Sigma$ - $\Delta$  ADC Operation, Removal of Noise Energy from the Band of Interest (Linear Scale X-Axis)

The  $\Sigma$ - $\Delta$  ADC starts the conversions of the input signal after the supplies generated by the internal LDOs become stable. An external signal is not required to generate the conversions.

### ANALOG INPUTS

The AD7770 can be operated in bipolar or unipolar modes and accepts true differential, pseudo differential, and single-ended input signals, as shown in Figure 86 through Figure 89.

Table 10 summarizes the maximum differential input signal and dynamic range for the different input modes.

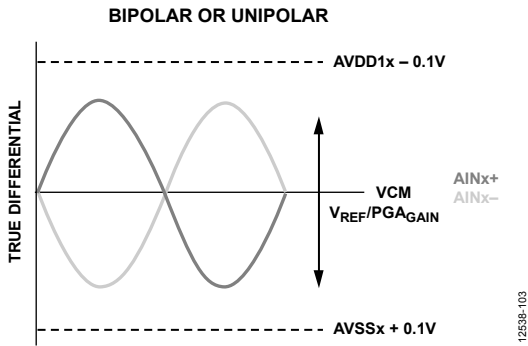

Figure 86.  $\Sigma$ - $\Delta$  ADC Input Signal Configuration, True Differential

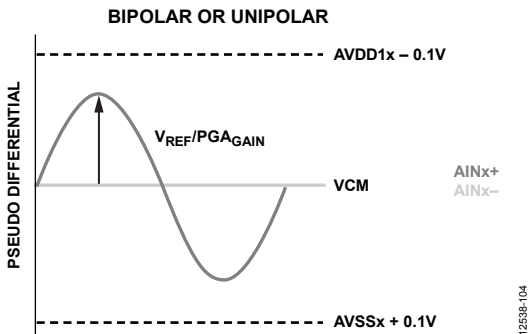

Figure 87.  $\Sigma$ - $\Delta$  ADC Input Signal Configuration, Pseudo Differential

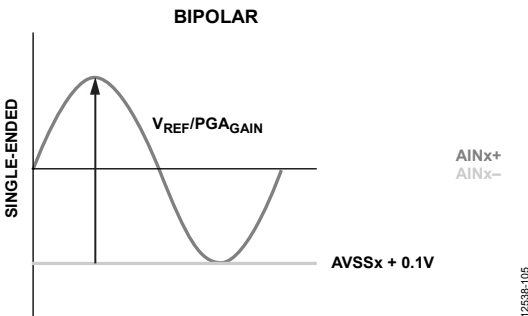

Figure 88.  $\Sigma$ - $\Delta$  ADC Input Signal Configuration, Single-Ended Bipolar

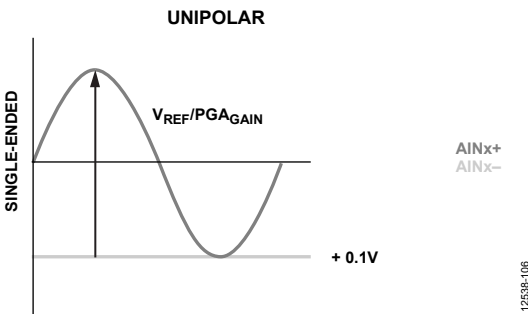

Figure 89.  $\Sigma$ - $\Delta$  ADC Input Signal Configuration, Single-Ended Unipolar

The common-mode input signal is not limited, but keep the absolute input signal voltage on any  $AINx\pm$  pin between  $AVSSx + 100\text{ mV}$  and  $AVDD1x - 100\text{ mV}$ ; otherwise, the input signal linearity degrades and, if the signal voltage exceeds the absolute maximum signal rating, damages the device.

Figure 90 shows the maximum and minimum voltage common-mode range at different PGA gains for a maximum differential input voltage.

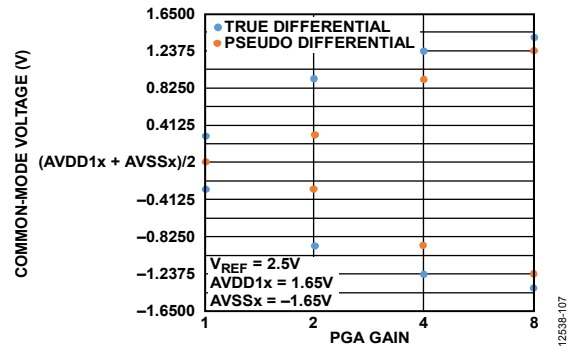

Figure 90. Maximum Common-Mode Voltage Range for a Maximum Differential Input Signal

The AD7770 provides a common-mode voltage pin ( $AVDD1x + AVSSx/2$ ), VCM, for the single-supply, pseudo differential, or true differential input configurations.

### TRANSFER FUNCTION

The AD7770 can operate with up to a 3.6 V reference, typical at 2.5 V, and converts the differential voltage between the analog inputs ( $AINx+$  and  $AINx-$ ) into a digital output. The ADC converts the voltage difference between the analog input pins ( $AINx+ - AINx-$ ) into a digital code on the output. The 24-bit conversion result is in MSB first, twos complement format, as shown in Table 11 and Figure 91.

Table 11. Output Codes and Ideal Input Voltages for  $PGA = 1\times$

Condition	Analog Input (( $AINx+$ ) - ( $AINx-$ )), $V_{REF} = 2.5\text{ V}$	Digital Output Code, Twos Complement (Hex)
FS - 1 LSB	+2.499999702 V	0x7FFFFF
Midscale + 1 LSB	+298 nV	0x000001
Midscale	0 V	0x000000
Midscale - 1 LSB	-298 nV	0xFFFFF
-FS + 1 LSB	-2.499999702 V	0x800001
-FS	-2.5 V	0x800000

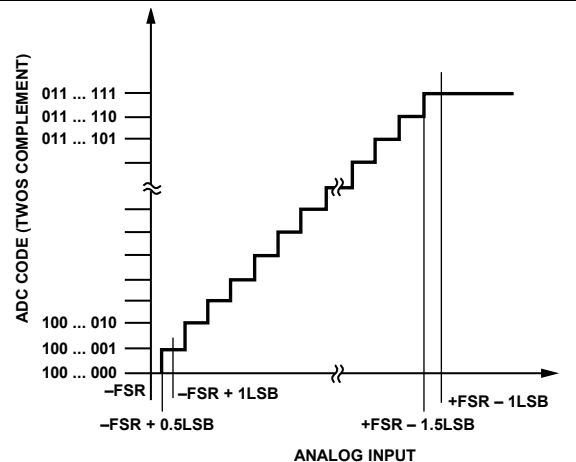

Figure 91. Transfer Function

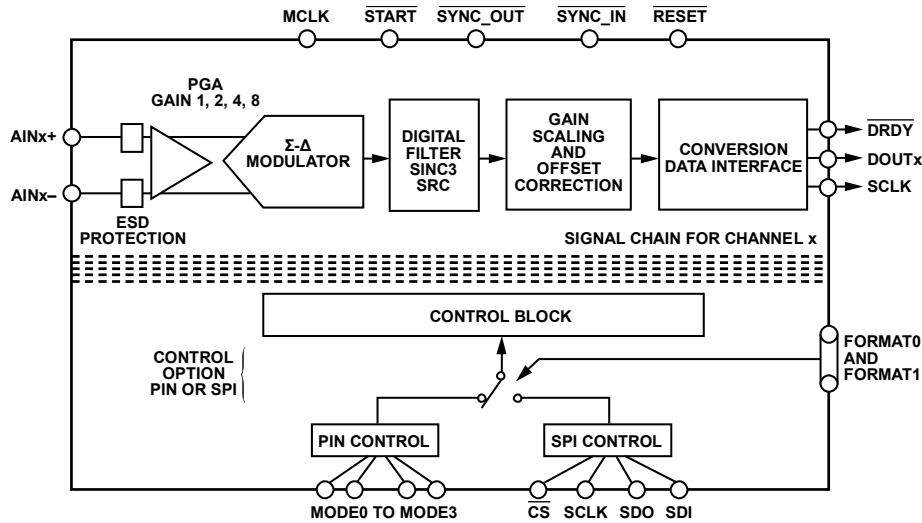

Figure 92. Top Level Core Signal Chain

**CORE SIGNAL CHAIN**

Each  $\Sigma$ - $\Delta$  ADC channel on the AD7770 has an identical signal path from the analog input pins to the digital output pins. Figure 92 shows a top level implementation of this signal chain. Prior to each  $\Sigma$ - $\Delta$  ADC, a PGA maps sensor outputs into the ADC inputs, providing low input current in dc ( $\pm 8$  nA in high resolution mode) single-ended input current, and  $\pm 4$  nA differential input current in high resolution mode), an 8 pF input capacitance in ac, and configurable gains of 1, 2, 4, and 8. See the AN-1392 Application Note for more information. Each ADC channel has its own  $\Sigma$ - $\Delta$  modulator, which oversamples the analog input and passes the digital representation to the digital filter block. The data is filtered, scaled for gain and offset, and is then output on the data interface.

To minimize power consumption, the channels can be individually disabled.

**CAPACITIVE PGA**

Each  $\Sigma$ - $\Delta$  ADC has a dedicated PGA, offering gain ranges of 1, 2, 4, and 8. This PGA reduces the need for an external input buffer and allows the user to amplify small sensor signals to use the full dynamic range of the AD7770. The PGA maximize the signal chain dynamic range for small sensor output signals.

The AD7770 uses chopping of the PGA to minimize offset and offset drift in the input amplifier, reducing the  $1/f$  noise as well. For the AD7770, the chopping frequency is set to 128 kHz for high resolution mode, and 32 kHz for low power mode (see the AN-1392 Application Note for more information). The chopping tone is rejected by the sinc3 filter.

To minimize intermodulation effects that may cause image in the band of interest, it is recommended to limit the input signal bandwidth to  $2/3$  of the chop frequency.

The capacitive PGA common-mode voltage does not depend on the gain, and can be any value as long as the input signal voltage is within  $AVSSx + 100$  mV to  $AVDD1x - 100$  mV. See Figure 90

for the maximum common-mode voltage at maximum differential input signals.

**INTERNAL REFERENCE AND REFERENCE BUFFERS**

The AD7770 integrates a 2.5 V,  $\pm 10$  ppm/ $^{\circ}$ C typical, voltage reference that is disabled at power-up. The buffered reference is available at Pin 49 and offers up to 10 mA of continuous current. A 100 nF capacitor is required if the reference is enabled.

In applications where a low noise reference is required, it is recommended to add a low-pass filter (LPF) with a cutoff frequency ( $f_{CUTOFF}$ ) below 10 Hz to the REF\_OUT pin. Connect the output of this filter to REFx+, and connect AVSSx to REFx-. In this scenario, configure the  $\Sigma$ - $\Delta$  reference to be external by configuring the reference buffers in enable or precharge mode. An example of performance with and without the output filter is shown in Figure 93.

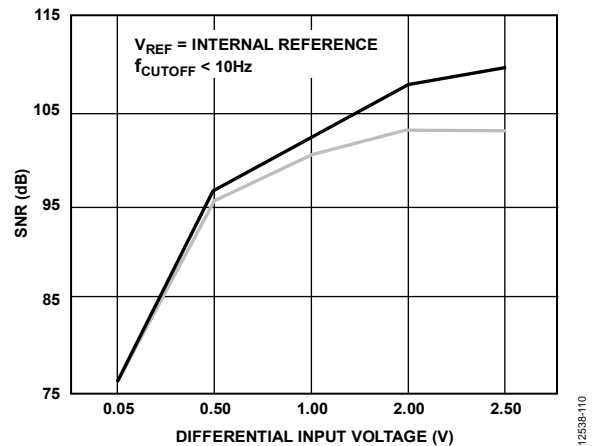

Figure 93. SNR Adding External LPF with  $V_{REF} =$  Internal Reference and  $f_{CUTOFF} < 10$  Hz

The AD7770 can be used with an external reference connected between the REFx+ and REFx- pins. Recommended reference voltage sources for the AD7770 include the ADR441 and ADR4525 family of low noise, high accuracy voltage references.

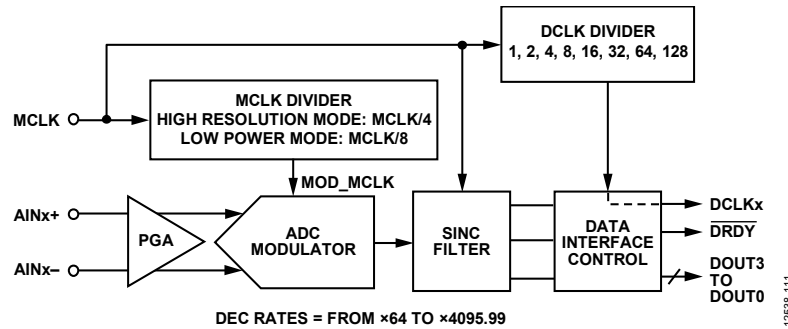

Figure 94. Clock Generation on the AD7770

The reference buffers can be operated in three different modes: buffer enabled mode, buffer bypassed mode, and buffer pre-Q mode.

In buffer enabled mode, the buffer is fully enabled, minimizing the current requirements from the external references. Note that the buffer output voltage headroom is  $\pm 100$  mV from the rails.

In buffer bypassed mode, the external reference is directly connected to the ADC reference capacitors; the reference must provide enough current to correctly charge the internal ADC reference capacitors. In this mode of operation, a slight degradation in crosstalk is expected because the ADC channels are not isolated from each other.

Buffer pre-charged (pre-Q) mode is the default operation mode. It is a hybrid mode where the internal reference buffers are connected during the initial acquisition time to precharge the internal ADC reference capacitors. During the final phase of the acquisition, the reference is connected directly to the ADC capacitors. This mode has some benefits compared to the buffer enabled and buffer bypassed modes. In buffer pre-Q mode, the reference current requirements are minimized compared to buffer bypassed mode and the noise contribution from the internal reference buffers is removed (compared to buffer enabled mode).

In buffer pre-Q mode, the headroom/footroom of the buffer reference is not applicable because the reference sets the final voltage in the ADC reference capacitors.

## INTEGRATED LDOs

The AD7770 has three internal LDOs to regulate the internal supplies: two LDOs for the analog block and one LDO for the digital core. The internal LDOs requires an external 1  $\mu$ F decoupling capacitor on the DREGCAP, AREG1CAP, and the AREG2CAP pins. The LDO slew rate may be low because it depends on the main supply slew rate; therefore, a hardware reset generated by pulsing the RESET pin at power-up is required to guarantee that the digital block initializes correctly.

## CLOCKING AND SAMPLING

The AD7770 includes eight  $\Sigma$ - $\Delta$  ADC cores. Each ADC receives the same master clock signal. The AD7770 requires a maximum external MCLK frequency of 8192 kHz for high resolution mode and 4096 kHz for low power mode. The MCLK is internally divided by 4 in high performance mode and by 8 in low power mode to produce the modulator MCLK (MOD\_MCLK) signal used as the modulator sampling clock for the ADCs. The MCLK can be decreased to accommodate lower ODRs if the minimum ODR selected by the sinc3 filter is not low enough. If the external clock is lower than 256 kHz, set the CLK\_QUAL\_DIS bit (in SPI control mode only).

The AD7770 integrates an internal oscillator clock that initializes the internal registers at power-up. The CLK\_SEL pin defines the external clock used after initialization (see Table 12).

Table 12. Clock Sources

CLK_SEL State	Clock Source	Connection
0	CMOS	Input to XTAL2/MCLK, IOVDD logic level. XTAL1 must be tied to DGND.
1	Crystal	Connected between XTAL1 and XTAL2/MCLK.

The MCLK signal generates the DCLK output signal, which in turn clocks the  $\Sigma$ - $\Delta$  conversion data from the AD7770, as shown in Figure 94.

## DIGITAL RESET AND SYNCHRONIZATION PINS

An external pulse in the SYNC\_IN pin generates the internal reset of the digital block; this pulse does not affect the data programmed in the internal registers. A pulse in this pin is required in two cases as follows:

- After updating one or more registers directly related to the sinc3 filter. These are power mode, offset, gain, and phase compensation.
- To synchronize multiple devices.

The pulse in the SYNC\_IN pin must be synchronous with MCLK.

There are two different ways to achieve a synchronous pulse if the controller/processor cannot generate it, as follows:

- Applying an asynchronous pulse on the START pin, which is then internally synchronized with the external MCLK clock, and the resulting synchronous signal is output on the SYNC\_OUT pin.
- Triggering the SYNC\_OUT internally. When the AD7770 is configured in SPI control mode, toggling Bit 0 in the GENERAL\_USER\_CONFIG\_2 register generates a synchronous pulse that is output on the SYNC\_OUT pin.

The SYNC\_IN and SYNC\_OUT pins must be externally connected if internal synchronization is used.

If multiple AD7770 devices must be synchronized, the SYNC\_OUT pin of one device can be connected to multiple devices. This synchronization method requires the use of a common MCLK signal for all the AD7770 devices connected, as shown in Figure 95.

If the START pin is not used, tie it to IOVDD.

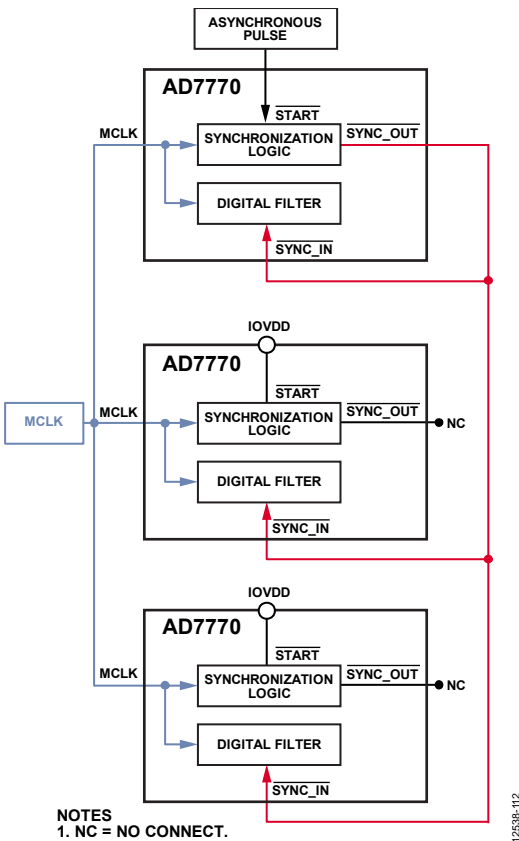

Figure 95. Multiple AD7770 Devices Synchronization

### DIGITAL FILTERING

The AD7770 offers a low latency sinc3 filter. Most precision  $\Sigma$ - $\Delta$  ADCs use sinc3 filters because the sinc3 filter offers a low latency path for applications requiring low bandwidth signals, for example, in control loops or where application specific postprocessing is required. The digital filter adds notches at multiples of the sampling frequency.

The digital filter implements three main notches, one at the maximum ODR (32 kHz or 8 kHz, depending on the power mode) and another two at the ODR frequency selected to stop noise aliasing into the pass band.

Figure 96 shows the typical filter transfer function for the high resolution and low power modes using a decimation rate of 128.

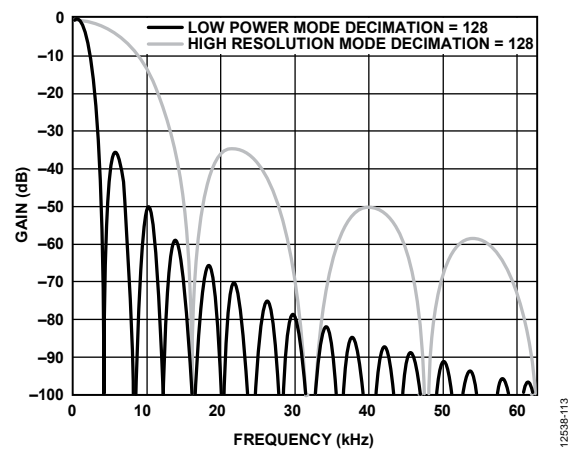

Figure 96. Sinc3 Frequency Response

The sample rate converter featured allows fine tuning of the decimation rate, even for noninteger multiples of the decimation rate. See the SRC section for more information on filter profiles for noninteger decimation rates.

### SHUTDOWN MODE

The AD7770 can be placed in shutdown mode by pulling AVDD2 to ground and connecting 1 M $\Omega$  resistance, pulled low, to XTAL2. In this mode, the average current consumption is reduced below 1 mA, as shown in Figure 97.

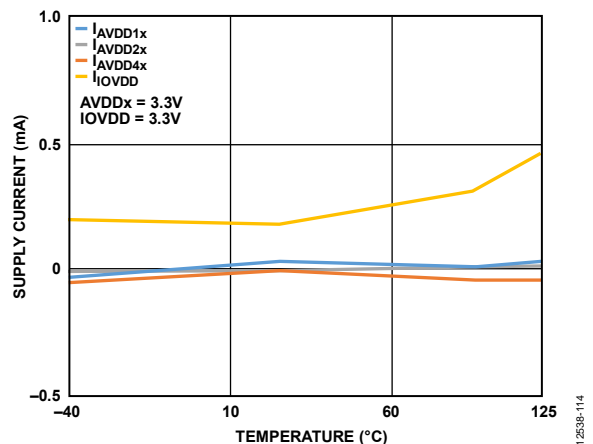

Figure 97. Shutdown Current

## CONTROLLING THE AD7770

The AD7770 can be controlled using either pin control mode or SPI control mode.

Pin control mode allows the AD7770 to be hardwired to predefined settings that offer a subset of the overall functionality of the AD7770. In this mode, the SRC and diagnostic features or extended errors source are not available.

Controlling the AD7770 over the SPI allows the user access to the full monitoring, diagnostic, and  $\Sigma$ - $\Delta$  control functionality. SPI control offers additional functionality such as offset, gain, and phase correction per channel, in addition to access to the flexible SRC to achieve a coherent sampling.

See Table 13 for more details about these different configurations.

## PIN CONTROL MODE

In pin control mode, the AD7770 is configured at power-up based on the level of the mode pins, MODE0, MODE1, MODE2, and MODE3. These four pins set the following functions on the AD7770: the mode of operation, the decimation rate/ODR, the PGA gain, and the reference source, as shown in Table 14.

Due to the limited number of mode pins and the number of options available, the PGA gain control is grouped into blocks

of 4, and the ODR is selected for the maximum value defined by the decimation rate; ODR (kHz) = 2048/decimation for high resolution mode, and ODR (kHz) = 512/decimation for low power mode.

Depending on the mode selected, the device is configured to use an external or an internal reference.

The conversion data can be read back using the SPI or the data output interface, as shown in Table 13. If the data output interface is used to read back the data from the conversions, the number of DOUTx lines enabled and the number of clocks required for the  $\Sigma$ - $\Delta$  data transfer are determined by the logic level of the CONVST\_SAR, FORMAT0, and FORMAT1 pins. In this case, the DCLK2, DCLK1, and DCLK0 pins select the  $\Sigma$ - $\Delta$  output interface and control the DCLKx divide function, which is a submultiple of MCLK, as shown in Table 15. The DCLKx divide function sets the frequency of the data output interface DCLKx signal. The DCLK minimum frequency depends on the decimation rate and operation mode. See the Data Output Interface section for more details about the minimum DCLKx frequency.

All the pins that define the AD7770 configuration mode are reevaluated each time the SYNC\_IN pin is pulsed. The typical connection diagram for pin control mode is shown in Figure 98.

Table 13. Format of the Data Interface

CONVST_SAR State	FORMAT1	FORMAT0	Control Mode	Data Output Mode
1	0	0	Pin	SPI output
	0	1	Pin	SPI output
	1	1	Pin	SPI output
	1	1	SPI	Defined in Register 0x014
0	0	0	Pin	DOUT0, Channel 0 and Channel 1 DOUT1, Channel 2 and Channel 3 DOUT2, Channel 4 and Channel 5 DOUT3, Channel 6 to Channel 7
	0	1	Pin	DOUT0, Channel 0 to Channel 3 DOUT1, Channel 4 to Channel 7
	1	0	Pin	DOUT0, Channel 0 to Channel 7
	1	1	SPI	Defined in Register 0x014

Table 14. Pin Mode Options

Pin State				Decimation Rate	Power Mode	PGA Gain Channel		Reference Source
MODE3	MODE2	MODE1	MODE0			Channel 0 to Channel 3	Channel 4 to Channel 7	
0	0	0	0	1024	High resolution	1	1	External
0	0	0	1	512	High resolution	1	1	External
0	0	1	0	256	High resolution	1	1	External
0	0	1	1	128	High resolution	1	1	External
0	1	0	0	64	High resolution	1	1	External
0	1	0	1	512	High resolution	1	4	External
0	1	1	0	256	High resolution	1	4	External
0	1	1	1	128	High resolution	1	4	External
1	0	0	0	64	High resolution	1	4	External

Pin State				Decimation Rate	Power Mode	PGA Gain Channel		Reference Source
MODE3	MODE2	MODE1	MODE0			Channel 0 to Channel 3	Channel 4 to Channel 7	
1	0	0	1	512	High resolution	1	1	Internal
1	0	1	0	256	High resolution	1	1	Internal
1	0	1	1	128	High resolution	1	1	Internal
1	1	0	0	512	Low power	1	1	External
1	1	0	1	256	Low power	1	1	External
1	1	1	0	128	Low power	1	1	External
1	1	1	1	64	Low power	1	1	External

Table 15. DCLKx Selection for Pin Control Mode State

DCLK2/SCLK	DCLK1/SDI	DCLK0/SDO	MCLK Divider
0	0	0	1
0	0	1	2
0	1	0	4
0	1	1	8
1	0	0	16
1	0	1	32
1	1	0	64
1	1	1	128

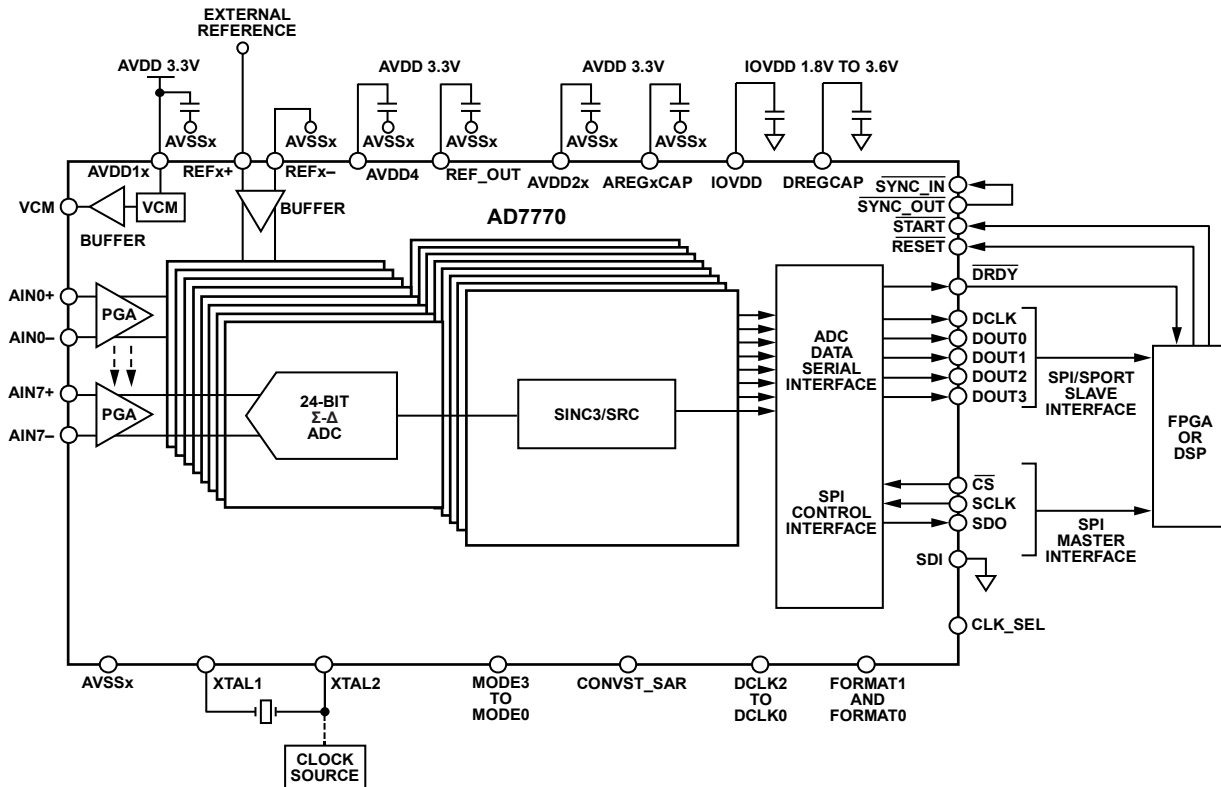

Figure 98. Pin Mode Connection Diagram with External Reference

12538-115



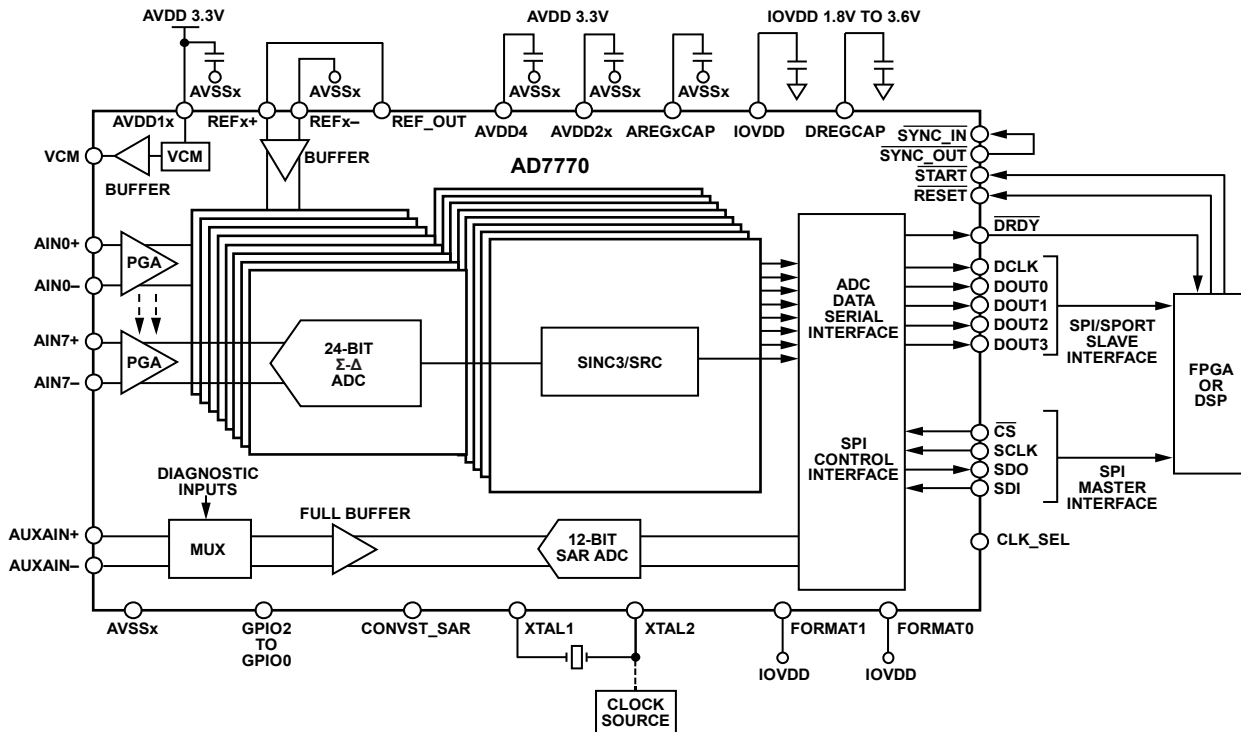

Figure 99. SPI Control Mode Connection Diagram with Internal Reference

## SPI CONTROL

The second option for control and monitoring the [AD7770](#) is via the SPI. This option allows access to the full functionality on the [AD7770](#), including access to the SAR converter, phase synchronization, offset and gain adjustment, diagnostics and the SRC. To use the SPI control, set the `FORMAT0` and `FORMAT1` pins to logic high.

In this mode, the SPI can also read the  $\Sigma$ - $\Delta$  conversation data by setting the `SPI_SLAVE_MODE_EN` bit.

The typical connection diagram for SPI control mode is shown in Figure 99.

### Functionality Available in SPI Mode

SPI control of the [AD7770](#) offers the super set of the functions and diagnostics. The SPI Control Functionality section describes the functionality and diagnostics offered when in SPI control mode.

### Offset and Gain Correction

Offset and gain registers are available for system calibration. The gain register is preprogrammed during final production for a PGA gain of 1, but can be overwritten with a new value if required.

The gain register is 24 bits long and is split across three registers, `CHx_GAIN_UPPER_BYTE`, `CHx_GAIN_MID_BYTE`, and `CHx_GAIN_LOWER_BYTE`, which set the gain on a per channel basis. The gain value is relative to `0x555555`, which represents a gain of 1.

The offset register is 24 bits long and is spread across three byte registers, `CHx_OFFSET_UPPER_BYTE`, `CHx_OFFSET_MID_BYTE`, and `CHx_OFFSET_LOWER_BYTE`. The default value is

`0x000000` at power-up. Program the offset as a two's complement, signed 24-bit number. If the channel gain is set to its nominal value of `0x555555`, an LSB of offset register adjustment changes the digital output by  $-4/3$  LSBs.

As an example of calibration, the offset measured is  $-200$  LSB (with both `AINx±` pins connected to the same potential).

An offset adjustment of  $-150$  LSB changes the digital output by  $-150 \times (-4/3) = 200$  LSBs (gain value = `0x555555`), representing this number as two's complement, `0xFFFFF7` - `0x96` + 1 = `0xFFFFF70`. Program the offset register as follows:

- `CHx_OFFSET_UPPER_BYTE` = `0xFF`
- `CHx_OFFSET_MID_BYTE` = `0xFF`
- `CHx_OFFSET_LOWER_BYTE` = `0x70`

Note that the offset compensation is performed before the gain compensation. The gain is programmed during final testing for `PGA_GAIN` = 1. The gain register values can be overwritten; however, after a reset or power cycle, the gain register values revert to the hard coded programmed factory setting.

If the gain required is 0.75 of the nominal value (`0x555555`), the value that must be programmed is

$$0x555555 \times 0.75 = 0x400000$$

Then, an LSB of the offset register adjustment changes the digital output by  $-4/3 \times 0.75 = 1$  LSB. Program the gain register as follows:

- `CHx_GAIN_UPPER_BYTE` = `0x40`
- `CHx_GAIN_MID_BYTE` = `0x00`
- `CHx_GAIN_LOWER_BYTE` = `0x00`

## SPI Control Functionality

### Global Control Functions

The following list details the global control functions of the AD7770:

- High resolution and low power modes of operation
- ODR: SRC
- VCM buffer power-down
- Internal/external reference selection
- Enable, precharged, or bypassed reference buffer modes
- Internal reference power-down
- SAR diagnostic mux
- SAR power-down
- GPIO write/read
- SPI SAR conversion readback
- SPI slave mode—read  $\Sigma$ - $\Delta$  results
- SDO and DOUTx drive strength
- DOUTx mode
- DCLK division
- Internal LDO bypassed
- CRC protection: enabled or disabled

### Per Channel Functions

The following list details the per channel functions of the AD7770:

- PGA gain
- $\Sigma$ - $\Delta$  channel power-down
- Phase delay: synchronization phase offset per channel
- Calibration of offset
- Calibration of gain
- $\Sigma$ - $\Delta$  input signal mux
- Channel error register
- PGA gain

### Phase Adjustment

The AD7770 phase delay can be adjusted to compensate for phase mismatches between channels due to sensors or signal channel phase errors connected to the AD7770. Achieve phase adjustment by programming the CHx\_SYNC\_OFFSET register. This programming delays the synchronization signal by a certain number of modulator clocks (MOD\_CLK) to individually initiate the digital filter for each  $\Sigma$ - $\Delta$  ADC. In others words, program the channel with a higher phase with Phase 0, whereas for the channel with lower phase, delay to compensate the phase mismatch.

The phase adjustment register is read after a pulse on the SYNC\_IN pin; consequently, any further changes on the register have no effect unless a pulse is generated (see the Digital Reset and Synchronization Pins section for more information on how to generate a pulse in the pin).

The phase offset register is multiplied internally by a factor (n) that depends on the decimation rate, as shown in Table 16.

**Table 16. Phase Adjustment vs. Decimation Rate**

Phase Adjustment Compensation (n)	Decimation Rate
×1	≤255
×2	≤511
×4	≤1023
×8	≤2047
×16	≤4095

The maximum phase delay cannot be equal to or greater than the decimation rate. If this is the case, the value changes internally to the decimation rate value minus 1.

When the CHx\_SYNC\_OFFSET register is written it automatically overwrites itself multiplied by the corresponding factor (n), as defined in Table 12. As CHx\_SYNC\_OFFSET is only 8 bits long, the resulting value will be scaled down to fit 8 bits. In order to know whether the phase adjustment has clipped or not, see Table 17.

**Table 17.**

CHx_SYNC_OFFSET × n	CHx_SYNC_OFFSET Overwrite
≤255	CHx_SYNC_OFFSET × n
≤511	CHx_SYNC_OFFSET × n/2
≤1023	CHx_SYNC_OFFSET × n/4
≤2047	CHx_SYNC_OFFSET × n/8
≤4095	CHx_SYNC_OFFSET × n/16

As an example, the phase mismatch between Channel 0 and Channel 1 is 5°, and the ODR is 5 kSPS in high resolution mode. In this case, the decimation rate is 2048 kHz/5 kHz = 409.6, which means that the offset register value is multiplied internally by 2.

Assuming an input signal of 50 Hz, the number of MOD\_MCLK pulses required to sample a full period is 2048 kHz/50 Hz = 40960 > 360°/40960 = 0.00878°.

If a 5° delay is required, the number of MOD\_MCLK delays must be 569 (5°/0.00878°) because the offset register is multiplied by 2; the final offset register value is 409.6/2 – 569/2, which gives a negative value. In this case, if the offset value programmed to the register is higher than 204 (for example, 210 × 2 = 420), the value is internally changed to 408, resulting in a phase compensation of 408 × 0.00878° = 3.58°.

### PGA Gain

The PGA gain can be selected individually by appropriately selecting Bits[7:6] in the CHx\_CONFIG register, as shown in Table 18.

**Table 18. PGA Gain Settings via CHx\_CONFIG**

CHx_CONFIG, Bits[7:6] Setting	PGA Gain Setting
00	1
01	2
10	4
11	8

If the  $\Sigma$ - $\Delta$  reference is updated, it is recommended to apply a pulse on the SYNC\_IN pin to remove invalid samples during the transition of the reference

### Decimation

The decimation defines the sampling frequency as follows:

- In high resolution mode, the sampling frequency = MCLK/ (4 × decimation)
- In low power mode, the sampling frequency = MCLK/ (8 × decimation)

Refer to the SRC section for more information.

### GPIOx Pins

If the AD7770 operates in SPI control mode, the mode pins operate as GPIOx pins, as shown in Figure 100. The GPIOx pins can be configured as inputs or outputs in any order.

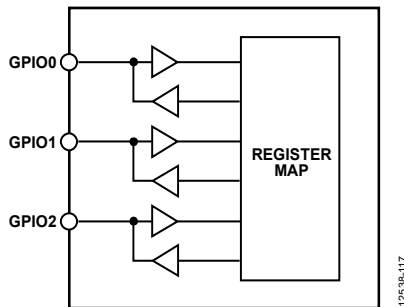

Figure 100. GPIOx Pin Functionality

Configuration control and readback of the GPIOx pins are set via Bits[2:0] in the GPIO\_CONFIG register (0 = input, 1 = output)

Table 20. Reference Buffer Operation Modes

Reference Buffer Operation Mode	REFx+	REFx-
Enabled	BUFFER_CONFIG_1, Bit 4 = 1; BUFFER_CONFIG_2, Bit 7 = 0	BUFFER_CONFIG_1, Bit 3 = 1; BUFFER_CONFIG_2, Bit 6 = 0
Precharged	BUFFER_CONFIG_1, Bit 4 = 1; BUFFER_CONFIG_2, Bit 7 = 1	BUFFER_CONFIG_1, Bit 3 = 1; BUFFER_CONFIG_2, Bit 6 = 1
Disabled	BUFFER_CONFIG_1, Bit 4 = 0	BUFFER_CONFIG_1, Bit 3 = 0

Table 21. Additional Disable Power-Down Blocks

Block	Register	Notes
VCM	GENERAL_USER_CONFIG_1, Bit 5	Enable by default
Reference Buffer	BUFFER_CONFIG_1, Bits[4:3]	Precharged mode by default
Internal Reference Buffer	GENERAL_USER_CONFIG_1, Bit 4	Disable by default
$\Sigma$ - $\Delta$ Channel	CH_DISABLE, Bits[7:0]	All channels enable
SAR	GENERAL_USER_CONFIG_1, Bit 3	Disable by default
Internal Oscillator	GENERAL_USER_CONFIG_1, Bit 2	Enable by default

and the GPIO\_DATA register. Among other uses, the GPIOs can control an external mux connected to the auxiliary inputs of the SAR ADC. Use this mux to verify the results on the  $\Sigma$ - $\Delta$  ADCs.

In addition, the GPIOx pins can be used to externally trigger a new decimation rate. Refer to the SRC section for more information about this functionality.

### $\Sigma$ - $\Delta$ Reference Configuration

The AD7770 can operate with internal or external references. In addition, for diagnostic purposes, the analog supply can be used as a reference, as shown in Table 19. REFx-/REFx+ allows the selection of a voltage reference where the REFx+ is lower voltage than REFx- pin.

Table 19.  $\Sigma$ - $\Delta$  References

Setting for ADC_MUX_CONFIG, Bits[7:6]	Channel 0 to Channel 3	Channel 4 to Channel 7
00	REF1+/REF1-	REF2+/REF2-
01	Internal reference	Internal reference
10	AVDD1A/AVSS1A	AVDD1B/AVSS1B
11	REF1-/REF1+	REF2-/REF2+

Reference buffer operation is described in Table 20. The selected reference and buffer operation mode affect all channels.

If the  $\Sigma$ - $\Delta$  reference is updated, it is recommended to apply a pulse on the SYNC\_IN pin to remove invalid samples during the transition of the reference.

**Power Modes**

The AD7770 offers different power modes to improve the power efficiency, high resolution and low power mode, which can be controlled via GENERAL\_USER\_CONFIG\_1, Bit 6. To further reduce the power, additional blocks can be disabled independently, as described in Table 21.

If the power mode changes, a pulse on the SYNC\_IN pin is required.

**LDO Bypassing**

The internal LDOs can be individually bypassed and an external supply can be applied directly to the AREG1CAP, AREG2CAP, or DREGCAP pin. Table 22 shows the absolute minimum and maximum supplies for these pins, as well as the associated register used to bypass the regulator.

**Table 22. LDO Bypassing**

LDO	BUFFER_CONFIG_2, Bits[2:0] <sup>1</sup>	Supply	
		Max (V)	Min (V)
AREG1CAP	1XX	1.9	1.85
AREG2CAP	X1X	1.9	1.85
DREGCAP	XX1	1.98	1.65

<sup>1</sup> X means don't care.

**DIGITAL SPI**

The SPI serial interface on the AD7770 consists of four signals: CS, SDI, SCLK, and SDO. A typical connection diagram of the SPI is shown in Figure 101.

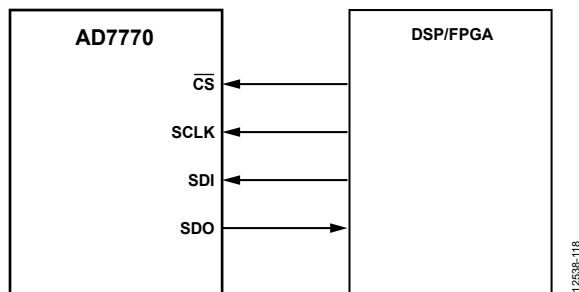

Figure 101. SPI Control Interface—AD7770 is the SPI Slave, Digital Signal Processor (DSP)/Field Programmable Gate Array (FPGA) is the Master

The SPI operates in Mode 0 and Mode 3: CPOL = 0, CPHA = 0 (Mode 0) or CPOL = 1, CPHA = 1 (Mode 3).

In pin control mode, the SDO can read back the Σ-Δ results, depending on the level of the CONVST\_SAR pin, as described in Table 13.

In SPI control mode, the SPI transfers data into the on-chip registers while the SDO pin reads back data from the on-chip registers or reads the SAR or the Σ-Δ conversions results, depending on the selected operation mode.

The SDO data source in SPI control mode is defined by the GENERAL\_USER\_CONFIG\_2 and GENERAL\_USER\_CONFIG\_3 registers, as described in Table 23.

**Table 23. SPI Operation Mode in SPI Control Mode**

GENERAL_USER_CONFIG_2, Bit 5 Setting	GENERAL_USER_CONFIG_3, Bit 4 Setting <sup>1</sup>	Mode
0	0	Internal register
0	1	Σ-Δ data conversion
1	X	SAR conversion

<sup>1</sup> X means don't care.

In SPI control mode, there are four different levels of I/O strength on the SDO pin that can be selected in GENERAL\_USER\_CONFIG\_2, Bits[4:3], as described in Table 24.

**Table 24. SDO Strength**

GENERAL_USER_CONFIG_2, Bits[4:3] Setting	Mode
00	Nominal
01	Strong
10	Weak
11	Extra strong

SCLK is the serial clock input for the device. All data transfers (on either SDO or SDI) occur with respect to this SCLK signal.

The SPI can operate in multiples of eight bits. For example, in SPI control mode, if the SDO pin is used to read back the data from the internal register or the SAR ADC, the data frame is 16 bits wide (CRC disabled), as shown in Figure 102, or 24 bits wide (CRC enabled), as shown in Figure 103. In this case, the controller can generate one frame of 16 bits or 24 bits (with and without the CRC enabled), or 2 or 3 frames of 8 bits (with and without the CRC enabled). When the SDO pin reads back the data from the Σ-Δ channels, 64 bits must be read back from the controller (in this case, the controller can generate a frame of 64 bits—either 2 × 32 bits, 4 × 16 bits, or 8 × 8 bits).

**SPI CRC—Checksum Protection (SPI Control Mode)**

The AD7770 has a checksum mode that improves SPI robustness in SPI control mode. Using the checksum ensures that only valid data is written to a register and allows data read from the device to be validated. The SPI CRC can be enabled by setting the SPI\_CRC\_TEST\_EN bit. If an error occurs during a register write, the SPI\_CRC\_ERR is set in the error register.

Enabling the SPI\_CRC\_TEST\_EN bit results in a CRC checksum being performed on all the R/W operations. When SPI\_CRC\_TEST\_EN is enabled, an 8-bit CRC word is appended to every SPI transaction for SAR and register map operations. For more information on Σ-Δ readback operations, see the CRC Header section.

To ensure that the register write is successful, it is recommended to read back the register and verify the checksum.

For CRC checksum calculations, the following polynomial is always used:  $x^8 + x^2 + x + 1$ . See the SPI Control Mode Checksum section for more information.

### SPI Read/Write Register Mode (SPI Control Mode)

The AD7770 has on-board registers to configure and control the device.

The registers have 7-bit addresses—the 7-bit register address on the SDI line selects the register for the read/write function. The 7-bit register address follows the  $\overline{R/\overline{W}}$  bit in the SDI data. The 8 bits on the SDI line following the 7-bit register address are the data to be written to the selected register if the SPI is a write transfer. Data on the SDI line is clocked into the AD7770 on the rising edge of SCLK, as shown in Figure 3.

The data on the SDO line during the SPI transfer contains the 8-bit 0010 0000 header: 8 bits of register data in the case of a read (R) operation, or 8 zeros in the case of a write (W) operation.

With the CRC disabled, the basic data frame on the SDI line during the transfer is 16 bits long, as shown in Figure 102. When the CRC is enabled, a minimum frame length of 24 SCLK periods are required on SPI transfers. The 24 bits of data on the SDO line consist of an 8-bit header (0010 0000), 8 bits of data, and an 8-bit CRC (see Figure 103).

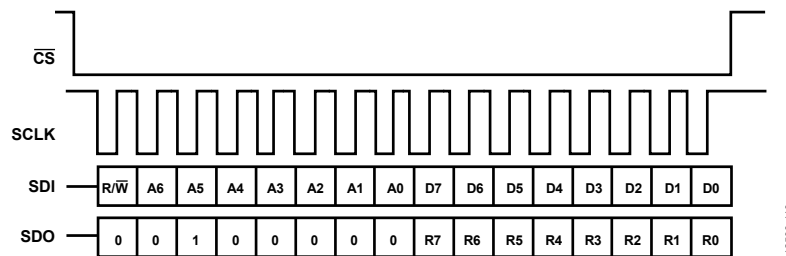

Figure 102. 16-Bit SPI Transfer—CRC Disabled

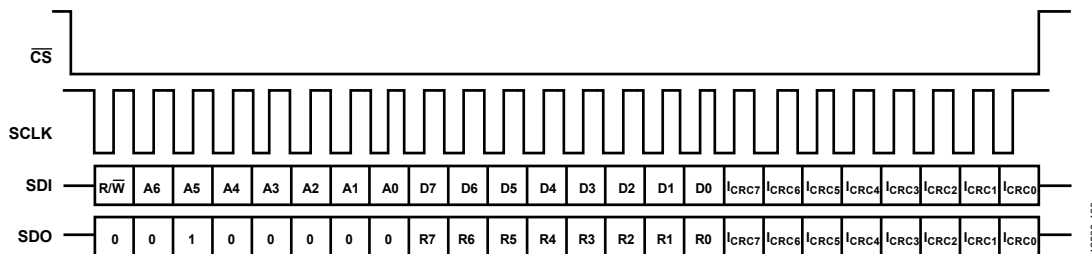

Figure 103. 24-Bit SPI Transfer—CRC Enabled

### SPI SAR Diagnostic Mode (SPI Control Mode)

Setting Bit 5 in the GENERAL\_USER\_CONFIG\_2 register configures the SDO line to shift out data from the SAR ADC conversions, as described in Table 23.

In SAR mode, the AD7770 internal registers can be written to, but any readback command is ignored because the SDO data frame is dedicated to shift out the conversion results from the SAR ADC.

To exit this mode of operation, reset Bit 5 in the GENERAL\_USER\_CONFIG\_2 register.

The data on the SDO line during the SPI transfer contains a 4-bit 0010 header and the 12-bit SAR conversion result if the CRC is disabled.

When the CRC is enabled, a minimum frame length of 24 SCLK periods are required on SPI transfers. The 24 bits of data on the SDO line consist of a 4-bit header (0010), the 12-bit data, and an 8-bit CRC, as shown in Figure 104.

Per the SPI read/write register mode (see the SPI Read/Write Register Mode section), the SDI line contains the  $\overline{R/\overline{W}}$  bit, a 7-bit register address, the 8-bit data, and an 8-bit CRC (if enabled). To avoid unwanted writes to the internal register while the SAR

conversions are read back through the SDO line, it is recommended to send a readback command, for example, 0x8000, to the device, which is ignored because the SDO pin shifts out the content of the SAR ADC.

If consecutive conversions are performed in the SAR ADC, read back the result from the previous conversion before a new conversion is generated. Otherwise, the results are corrupted.

### $\Sigma$ - $\Delta$ Data, ADC Mode

In pin control mode, the SPI can be used to read back the  $\Sigma$ - $\Delta$  conversions as described in Table 13. In SPI control mode, the SPI reads back the  $\Sigma$ - $\Delta$  conversions by setting GENERAL\_USER\_CONFIG\_3, Bit 4, as described in Table 23; in this mode, the AD7770 internal register can be written to, but any readback command is ignored because the SDO data frame is dedicated to shifting out the conversion results from the  $\Sigma$ - $\Delta$  ADCs. To avoid unwanted writes to the internal register, it is recommended to send a readback command, for example, 0x8000, to the device, which is ignored because the SDO pin shifts out the content of the  $\Sigma$ - $\Delta$  ADC.

The SDO pin data can be read back in any multiple of 8 bits, for example, as 64 bits,  $2 \times 32$  bits,  $4 \times 16$  bits, or  $8 \times 8$  bits.

**SPI Software Reset**

Keeping the SDI pin high during 64 consecutive clocks generates a software reset.

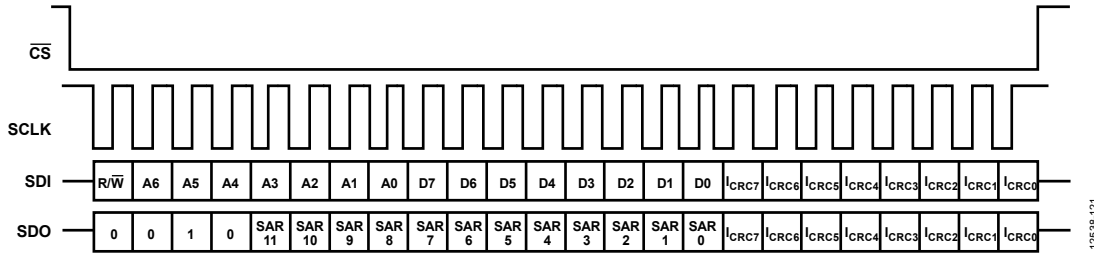

Figure 104. SAR ADC/Diagnostic Mode—CRC Enabled

12538-121

## RMS NOISE AND RESOLUTION

Table 25 through Table 27 show the dynamic range (DR), rms noise referred to input (RTI), effective number of bits (ENOB), and effective resolution (ER) of the AD7770 for various output data rates and gain settings. The numbers given are for the bipolar input range with an external 2.5 V reference. These numbers are typical and are generated with a differential input voltage of 0 V when the ADC is continuously converting on a single channel.

It is important to note that the effective resolution is calculated using the rms noise; 16,384 consecutive samples were used to calculate the rms noise.

$$\text{Effective Resolution} = \log_2(\text{Input Range}/\text{RMS Noise})$$

$$\text{ENOB} = (\text{DR} - 1.78)/6$$

## HIGH RESOLUTION MODE

Table 25. DR and RTI for High Resolution Mode

Decimation Rate	Output Data Rate (SPS)	f <sub>-3 dB</sub> (Hz)	Gain = 1		Gain = 2		Gain = 4		Gain = 8	
			DR (dB)	RTI (μV rms)	DR (dB)	RTI (μV rms)	DR (dB)	RTI (μV rms)	DR (dB)	RTI (μV rms)
64	32,000	8369	103.20	12.10	101.96	6.97	99.20	4.71	95.30	3.82
128	16,000	4818.8	109.43	6.00	108.30	3.39	105.07	2.38	100.71	1.94
256	8000	2511	112.97	4.00	112.38	2.13	110.23	1.39	105.98	1.13
512	4000	1269	116.00	2.80	115.86	1.45	113.68	0.92	109.81	0.7
1024	2000	636.3	119.00	1.98	119.19	1.01	116.75	0.65	113.12	0.51
2048	1000	318.5	123.00	1.38	121.98	0.72	119.79	0.46	115.88	0.35

Table 26. ENOB and ER for High Resolution Mode

Decimation Rate	Output Data Rate (SPS)	f <sub>-3 dB</sub> (Hz)	Gain = 1		Gain = 2		Gain = 4		Gain = 8	
			ENOB (Bits)	ER (Bits)	ENOB (Bits)	ER (Bits)	ENOB (Bits)	ER (Bits)	ENOB (Bits)	ER (Bits)
64	32,000	8369	17.14	18.66	16.94	18.45	16.48	18.02	15.83	17.32
128	16,000	4818.8	18.18	19.67	17.99	19.49	17.45	19.00	16.73	18.30
256	8000	2511	18.76	20.25	18.67	20.16	18.31	19.78	17.6	19.08
512	4000	1269	19.27	20.77	19.24	20.72	18.88	20.38	18.24	16.39
1024	2000	636.3	19.77	21.27	19.8	21.24	19.39	20.89	18.79	20.23
2048	1000	318.5	20.43	21.79	20.26	21.73	19.9	21.39	19.25	20.76

## LOW POWER MODE

Table 27. DR and RTI for Low Power Mode

Decimation Rate	Output Data Rate (SPS)	f <sub>-3 dB</sub> (Hz)	Gain = 1		Gain = 2		Gain = 4		Gain = 8	
			DR (dB)	RTI (μV rms)	DR (dB)	RTI (μV rms)	DR (dB)	RTI (μV rms)	DR (dB)	RTI (μV rms)
64	8000	2092.2	102.8	12.5	101.63	7.19	99.35	4.84	93.96	4.15
128	4000	1204.8	108.94	6.45	108.38	3.51	104.7	2.47	100.25	2.12
256	2000	627.75	112.7	4.23	112.01	2.24	109.4	1.49	105.18	1.18
512	1000	317.25	115.83	2.94	115	1.51	112.95	0.99	109.14	0.77
1024	500	159.25	118.97	2.04	118.72	1.05	116.43	0.67	112.47	0.54

Table 28. ENOB and ER for Low Power Mode

Decimation Rate	Output Data Rate (SPS)	f <sub>-3 dB</sub> (Hz)	Gain = 1		Gain = 2		Gain = 4		Gain = 8	
			ENOB (Bits)	ER (Bits)	ENOB (Bits)	ER (Bits)	ENOB (Bits)	ER (Bits)	ENOB (Bits)	ER (Bits)
64	8000	2092.2	17.07	18.61	16.88	18.41	16.5	17.98	15.61	17.2
128	4000	1204.8	18.09	19.56	18.00	19.44	17.39	18.95	16.65	18.17
256	2000	627.75	18.72	20.17	18.60	20.09	18.17	19.68	17.47	19.01
512	1000	317.25	19.24	20.70	19.10	20.66	18.76	20.27	18.13	19.62
1024	500	159.25	19.76	21.22	19.72	21.18	19.34	20.84	18.68	20.15

## DIAGNOSTICS AND MONITORING

### SELF DIAGNOSTICS ERROR

The AD7770 includes self diagnostic features to guarantee the correct operation. If an error is detected, the ALERT pin is pulled high to generate an external interruption to the controller. In addition, the header of the  $\Sigma$ - $\Delta$  output data contains an alert bit that informs the controller of a chip error (see the ADC Conversion Output—Header and Data section).

Both the ALERT pin and bit (status header) are automatically cleared if the error is no longer present. The errors related to the SPI do not recover automatically; read back the appropriate register to clear the error. The ALERT pin and bit reset in the next SPI access after the bit is read back.

If an error detector is manually disabled, it does not generate an internal error and, consequently, the register map or the ALERT pin and bit are not triggered.

There are different sources of errors, as described in Table 29. In pin control code, it is not possible to check the error source, and some sources of error are not enabled. In SPI control mode, check the source of an error by reading the appropriate register bit.

The STATUS\_REG\_x register bits identify the register that generates an error, as summarized in Table 29.

**Table 29. Register Error Source**

Bit Name	Register Source
ERR_LOC_GEN2	GEN_ERR_REG_2
ERR_LOC_GEN1	GEN_ERR_REG_1
ERR_LOC_CH7	CH7_ERR_REG
ERR_LOC_CH6	CH6_ERR_REG
ERR_LOC_CH5	CH5_ERR_REG
ERR_LOC_CH4	CH4_ERR_REG
ERR_LOC_CH3	CH3_ERR_REG
ERR_LOC_CH2	CH2_ERR_REG
ERR_LOC_CH1	CH1_ERR_REG
ERR_LOC_CH0	CH0_ERR_REG
ERR_LOC_SAT_CH6_7	CH6_7_SAT_ERR
ERR_LOC_SAT_CH4_5	CH4_5_SAT_ERR
ERR_LOC_SAT_CH2_3	CH2_3_SAT_ERR
ERR_LOC_SAT_CH0_1	CH0_1_SAT_ERR

In addition, the STATUS\_REG\_x registers have a bit that indicates if any internal error bit is set, ERROR. This bit clears if the error is no longer present and the register is read back.

The INIT\_COMPLETE bit in the STATUS\_REG\_3 indicates that the device is initialized correctly. This bit is not an error bit but an indicator.

#### General Errors

##### MCLK Switch Error (SPI Control Mode)

After power-up, the AD7770 initiates a clocking handover sequence to pass clocking control to the external oscillator, or the CMOS clock. In SPI mode, if an error occurs in the handover,

the EXT\_MCLK\_SWITCH\_ERR bit is set in the general error register, GEN\_ERR\_REG\_2.

If EXT\_MCLK\_SWITCH\_ERR is set, the device is operating off the internal oscillator, and is waiting for an appropriate external clock.

To use a slow external clock (<265 kHz), set the CLK\_QUAL\_DIS bit. Setting this bit also clears the error bit.

If the external clock is between 132 kHz and 265 kHz, depending on the internal synchronization between the internal oscillator and the external clock, the error may not trigger. However, it is still recommended to set the CLK\_QUAL\_DIS bit.

If a slow clock is not in use and the error triggers, a reset is required.

#### Reset Detection

The AD7770 general error register contains a RESET\_DETECTED bit. This bit is asserted if a reset pulse is applied to the AD7770 and is cleared by reading the general error register. This bit indicates that the power-on reset (POR) initialized correctly on the device. In addition, this bit can detect an unexpected device reset or glitch on the RESET pin. To reset this error signal in SPI control mode, toggle the SYNC\_IN pin or read from the general error register, GEN\_ERR\_REG\_2. To reset this error signal in pin control mode, toggle the SYNC\_IN pin.

#### Internal LDO Status

The AD7770 has three internal LDOs to regulate the internal analog and digital supply rails. The LDOs have internal power supply monitors. Internal comparators monitor and flag errors with these supplies after they pass a predetermined limit.

The ALDO1\_PSM\_ERR, ALDO2\_PSM\_ERR, and DLDO\_PSM\_ERR bits indicate either an LDO malfunction, or, if the LDOs are bypassed, an incorrect external supply.

The internal analog and digital voltage monitors can be disabled by appropriately selecting the LDO\_PSM\_TEST\_EN bits.

Use the SAR ADC to verify the error.

Additionally, the levels of the internal monitors can be manually triggered to check if the detector works correctly by appropriately setting the LDO\_PSM\_TRIP\_TEST\_EN bits. These bits increase the comparator window threshold above the LDO outputs, forcing the comparator to trigger.

#### ROM and Memory Map CRC

If an error is found at power-up during the ROM verification, or if the internal memory map is corrupted, the AD7770 generates an error and sets MEMMAP\_CRC\_ERR or ROM\_CRC\_ERR, depending on the source of the error.

The checker can be disabled by clearing the MEMMAP\_CRC\_TEST\_EN and ROM\_CRC\_TEST\_EN bits. The device must be reset if any of these errors trigger.



## $\Sigma$ - $\Delta$ ADC Errors

### Reference Detect (SPI Control Mode)

In SPI control mode, the AD7770 includes on-chip circuitry to detect if there is a valid reference for conversions or calibrations. If the voltage between the selected REF<sub>x+</sub> and REF<sub>x-</sub> pins goes below 0.7 V, the AD7770 detects that it no longer has a valid reference. CH<sub>x</sub>\_ERR\_REF\_DET can be interrogated to identify the affected channel, which clears the bit register if the error is no longer present. The voltage detector can be disabled by clearing the REF\_DET\_TEST\_EN bit.

Use the  $\Sigma$ - $\Delta$  ADC diagnostic or the SAR ADC to verify the error.

### Overvoltage and Undervoltage Events

The AD7770 includes on-chip overvoltage/undervoltage circuitry on each analog input pin. When the voltage on an analog input pin goes above AVDD<sub>1x</sub> + 40 mV, the CH<sub>x</sub>\_ERR\_AIN<sub>x</sub>\_OV bit is set. The error disappears if the input voltage falls below AVDD<sub>1x</sub> - 40 mV.

If an undervoltage event occurs (AVSS<sub>x</sub> - 40 mV), the CH<sub>x</sub>\_ERR\_AIN<sub>x</sub>\_UV bit is set. The error disappears if the input voltage increases to AVSS<sub>x</sub> + 40 mV.

The CH<sub>x</sub>\_ERR\_AINM\_UV, CH<sub>x</sub>\_ERR\_AINM\_OV, CH<sub>x</sub>\_ERR\_AINP\_UV, and CH<sub>x</sub>\_ERR\_AINP\_OV bits can be read back to verify the affected channel input, which clears the bits if the error is no longer present. The overvoltage and undervoltage detection can be disabled independently by clearing the AINM\_UV\_TEST\_EN, AINM\_OV\_TEST\_EN, AINP\_UV\_TEST\_EN, or AINP\_OV\_TEST\_EN bits.

The input voltage can be checked independently with the SAR ADC.

### Modulator Saturation

The AD7770 includes modulator saturation detection on each of the  $\Sigma$ - $\Delta$  ADCs. If 20 consecutive codes for the modulator are either all 1s or 0s, this condition is flagged as a modulator saturation event. Reading the CH<sub>x</sub>\_ERR\_MOD\_SAT register clears the bit if the error corrects itself.

Modulator saturation detection can be disabled by clearing the MOD\_SAT\_TEST\_EN bit.

Note that the modulator input voltage is attenuated internally, which means that a modulator output of all 1s or 0s represents a modulator that is out of bounds and that a  $\overline{\text{RESET}}$  pulse is required.

### Filter Saturation

The AD7770 includes digital filter saturation detection on each  $\Sigma$ - $\Delta$  ADC channel. This detection indicates that the filter output is out of bounds, which represents an output code approximately 20% higher than positive or negative full scale. Reading the CH<sub>x</sub>\_ERR\_FILTER\_SAT bit clears the bit if the error corrects itself.

The detection can be disabled by clearing FILTER\_SAT\_TEST\_EN bit.

## Output Saturation

An output saturation event can occur when gain and offset calibration causes the output from the digital filter to clip at either positive or negative full scale. The output does not wrap. Reading the CH<sub>x</sub>\_ERR\_OUTPUT\_SAT bit clears the bit if the error corrects itself.

The detection can be disabled by clearing OUTPUT\_SAT\_TEST\_EN bit.

### SPI Transmission Errors (SPI Control Mode)

All SPI errors clear after reading GEN\_ERR\_REG\_1, which contains the SPI errors. These errors are not recovered automatically and, consequently, the ALERT pin and bit remain set until the error register is read back, and a new SPI frame is generated.

### CRC Checksum Error

If the CRC checksum is enabled by setting the SPI\_CRC\_TEST\_EN bit, an error bit, SPI\_CRC\_ERR, is raised if the CRC message does not match the message computed by the AD7770 internal CRC block. If the CRC message does not match the internally computed message, the register is not updated.

### SCLK Counter

If the number of clocks generated by the controller is not a multiple of 8 after  $\overline{\text{CS}}$  is pulled high, an error bit, SPI\_CLK\_COUNT\_ERR is raised. The last command multiple of 8 is executed; however, the SCLK counter can be disabled by setting the SPI\_CLK\_COUNT\_TEST\_EN bit.

### Invalid Read

When attempting to read back an invalid register address, the SPI\_INVALID\_READ\_ERR bit is set.

The invalid readback address detection can be disabled by setting the SPI\_INVALID\_READ\_TEST\_EN bit.

### Invalid Write

When attempting to write to an invalid register address or a read only register, the SPI\_INVALID\_WRITE\_ERR bit is set.

The invalid write address detection can be disabled by setting the SPI\_INVALID\_WRITE\_TEST\_EN bit.

## MONITORING USING THE AD7770 SAR ADC (SPI CONTROL MODE)

The AD7770 contains an on-chip SAR ADC for chip diagnostics, system diagnostics, or measurement verification. The SAR ADC has a 12-bit resolution. The AVDD<sub>4</sub> and AVSS<sub>4</sub> pins operate in complete independence of the  $\Sigma$ - $\Delta$  ADC supplies and, therefore, can be used for chip diagnostics in systems where functional safety is important. The reference for the SAR conversion process is taken from the SAR ADC supply voltage (AVDD<sub>4</sub>/AVSS<sub>4</sub>) and, therefore, the SAR analog input range is from AVSS<sub>4</sub> to AVDD<sub>4</sub>.

The SAR ADC has a maximum throughput rate of 256 kSPS. The CONVST\_SAR pin initiates a conversion on the SAR ADC. The maximum allowable frequency of the CONVST\_SAR pin is 256 kHz. If consecutive conversions are performed in the SAR ADC, read back the result from the previous conversion before a new conversion is generated. Otherwise, the results are corrupted.

The SAR ADC is only available in SPI control mode. To read conversion results from the SAR ADC, set the SAR\_DIAG\_MODE\_EN bit. After this bit is set, all data shifted out from the SDO pin originates from the SAR ADC conversion, as shown in Figure 105.

The CONVST\_SAR signal can be internally deglitched to avoid false triggers.

**Table 30. SAR Synchronization and Deglitching**

CONVST_DEGLITCH_DIS (Register 0x013, Bits[7:6])	Effect on CONVST_SAR
11	CONVST_SAR goes directly to the SAR
10	CONVST_SAR reaches the SAR when it is 1.5/MCLK cycles wide

Increase the acquisition time by 1.5/MCLK when the deglitch circuitry is enabled.

Prior to the SAR ADC, the AD7770 contains an internal multiplexer. This multiplexer can be configured over the SPI to set the inputs to the SAR ADC to be either internal circuit nodes (in the case of diagnostics) or to select the external AUXAIN+ and AUXAIN- pins.

Along with converting external voltages, the SAR ADC can monitor the internal nodes on the AVDD, IOVDD, and DGND pins and the DLDO and analog LDO (ALDO) outputs. Some voltages are internally attenuated by 6, and the resulting voltage is applied to the SAR ADC, as shown in Table 31. This attenuation is useful because variations in the power supply voltage can be monitored.

The input multiplexer of the SAR is controlled by the GLOBAL\_MUX\_CONFIG register, and the different inputs available are described in Table 31.

The SAR ADC also contains an SAR driver amplifier, as shown in Figure 106. This amplifier settles the SAR input to 12-bit accuracy within the  $t_{33}$  time. This driver amplifier helps minimize the kickback from the SAR converter to the global diagnostic mux input circuit nodes.

Use the auxiliary inputs, AUXAIN+ and AUXAIN-, to validate the  $\Sigma$ - $\Delta$  measurements. While operating in SPI control mode, the AD7770 has three available GPIOx ports controlled via the SPI. The GPIOx pins can be used to control an external, dual 8:1 multiplexer, which, in turn, samples the eight  $\Sigma$ - $\Delta$  channels. Use this diagnostic in applications where functional safety is required. This diagnostic aids in removing the need for a secondary external ADC to validate primary measurements on the  $\Sigma$ - $\Delta$  channels.

**Temperature Sensor**

The internal die temperature can be measured with an accuracy of  $\pm 2^\circ\text{C}$ . The differential voltage base emitter ( $DV_{BE}$ ) is proportional to the temperature measured referred to  $25^\circ\text{C}$ .

$$\text{Temperature } (^\circ\text{C}) = \frac{DV_{BE} - 0.6 \text{ V}}{2 \text{ mV}}$$

**Table 31. SAR Mux Inputs**

SAR Input	Positive Signal	Negative Signal	Attenuation $\div 6$
0	AUXAIN+	AUXAIN-	No
1	$DV_{BE}$	AVSSx	No
2	REF1+	REF1-	No
3	REF2+	REF2-	No
4	REF_OUT	AVSSx	No
5	VCM	AVSSx	No
6	AREG1CAP	AVSSx	Yes
7	AREG2CAP	AVSSx	Yes
8	DREGCAP	DGND	Yes
9	AVDD1A	AVSSx	Yes
10	AVDD1B	AVSSx	Yes
11	AVDD2A	AVSSx	Yes
12	AVDD2B	AVSSx	Yes
13	IOVDD	DGND	Yes
14	AVDD4	AVSSx	No
15	DGND	AVSSx	Yes
16	DGND	AVSSx	Yes
17	DGND	AVSSx	Yes
18	AVDD4	AVSSx	Yes
19	REF1+	AVSSx	No
20	REF2+	AVSSx	No
21	AVSSx	AVDD4	Yes

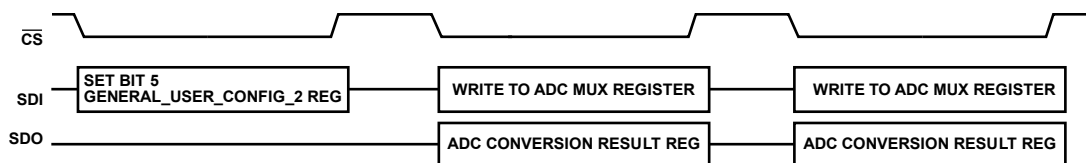

Figure 105. Configuring the AD7770 to Operate the SPI to Read from the SAR ADC

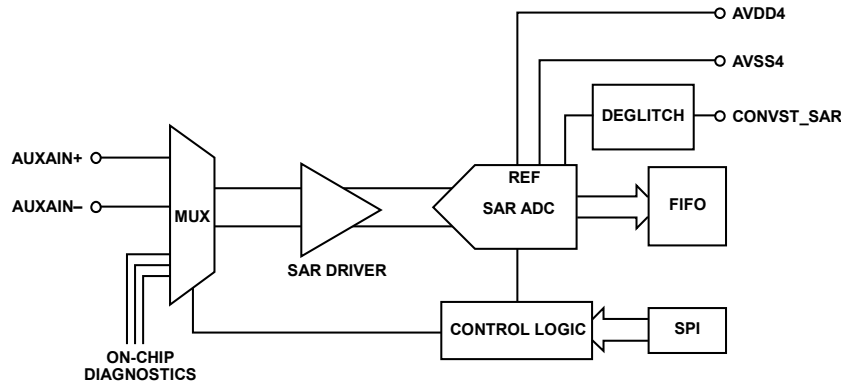

Figure 106. SAR ADC Configuration and Control

Table 32.  $\Sigma$ - $\Delta$  Diagnostic

Input	Voltage	Recommended Voltage Reference	Notes/Result
0	Floating	Not applicable	Not applicable
1	Floating	Not applicable	Not applicable
2	280 mV differential signal	Internal/external	PGA gain calibration
3	External reference, positive/negative	External	Positive full scale
4	External reference, negative/positive	External	Negative full scale
5	External reference, negative/negative	External	Zero scale
6	Internal reference, positive/negative	Internal	Positive full scale
7	Internal reference, negative/positive	Internal	Negative full scale
8	Internal reference, positive/positive	Internal	Zero scale
9	External reference, positive/positive	External	Zero scale

### $\Sigma$ - $\Delta$ ADC DIAGNOSTICS (SPI CONTROL MODE)

The AD7770  $\Sigma$ - $\Delta$  ADC diagnostic functions are accessible through the SPI. The internal mux placed before the PGA has different inputs, allowing the user to select a zero-scale, positive full-scale, or negative full-scale input to the  $\Sigma$ - $\Delta$  ADC, which can be converted to verify the correct operation of the  $\Sigma$ - $\Delta$  ADC channel.

The diagnostic mux control signals are shared across all the  $\Sigma$ - $\Delta$  channels. Depending on the diagnostic selected, connect the  $\Sigma$ - $\Delta$  ADC reference to a different reference source to guarantee that the conversion is within the measurable range.

There are two different ways to enable the diagnostic mux, as follows:

- Setting the CH<sub>x</sub>\_RX bit. This bit enables the input  $\Sigma$ - $\Delta$  mux. The multiplexer inputs are described in Table 32. The reference used during the conversions are controlled by the REF\_MUX\_CTRL bits.
- Setting CH<sub>x</sub>\_REF\_MONITOR. This bit has the same effect as enabling the CH<sub>x</sub>\_RX bit and selects the VDD1<sub>x</sub>/AVSS<sub>x</sub> supplies as the main reference.

If the AIN<sub>x</sub>± pin is connected to AVSS<sub>x</sub>, the input range is outside the range of AVSS<sub>x</sub> + 100 mV; therefore, results may differ slightly from the expected value.

Alternatively, the inputs can be used to calibrate gain and offset errors.

## Σ-Δ OUTPUT DATA

### ADC CONVERSION OUTPUT—HEADER AND DATA

The AD7770 Σ-Δ conversion results are output on the DOUT0 to DOUT3 pins or over the SPI, depending on the selected interface. If the DOUTx interface is selected, the AD7770 acts as the master in the transmission. If the SPI is selected, the controller is the master.

The  $\overline{\text{DRDY}}$  signal indicates the end of conversion independent of the interface selected to read back the Σ-Δ conversion. When the SPI reads back the Σ-Δ conversion, if a new conversion is completed ( $\overline{\text{DRDY}}$  falling edge) before the previous conversion is read back, the results from previous conversion are overwritten and, consequently, the previous conversion data is corrupted.

For each channel, the width is 32 bits long: 8 bits for the header and 24 bits for the Σ-Δ conversion, as shown in Figure 107.

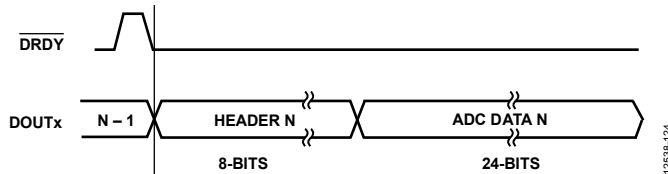

Figure 107. ADC Output—8-Bit Header Plus 24-Bit Conversion Data

In pin control mode, the header is fixed to the CRC while in SPI mode, and can be selected between CRC and error headers.

#### CRC Header

The CRC header is the header generated in pin control mode or in SPI mode if DOUT\_HEADER\_FORMAT is set.

As shown in Figure 108, the header consists of an alert bit, three bits for the ADC channel ID, as shown in Table 33, and four bits for the CRC.

The chip error bit is set high if an error is detected in any channel, as explained in the General Errors section. The alert bit remains 1 until the error disappears.

ALERT	CH_ID_2	CH_ID_1	CH_ID_0	CRC	CRC	CRC	CRC
-------	---------	---------	---------	-----	-----	-----	-----

Figure 108. CRC Header

Table 33. Channel ID

Channel	CH_ID_2	CH_ID_1	CH_ID_0
0	0	0	0
1	0	0	1
2	0	1	0
3	0	1	1
4	1	0	0
5	1	0	1
6	1	1	0
7	1	1	1

The CRC generated is eight bits long; the 4 MSBs are placed on the header for the first channel in the pairing and the 4 LSBs on the header of the second channel in the pairing, as shown in Table 34. If a channel is disabled, the 24-bit output data for this channel is 0x000000.

Table 34. 8-Bit CRC, Header Configuration (Channel 2)

ALERT	0	1	0	CRC7	CRC6	CRC5	CRC4
-------	---	---	---	------	------	------	------

Table 35. 8-Bit CRC, Header Configuration (Channel 3)

ALERT	0	1	1	CRC3	CRC2	CRC1	CRC0
-------	---	---	---	------	------	------	------

#### ERROR Header (SPI Control Mode)

In SPI control mode, the default header can be replaced by an error header. If the Σ-Δ conversion is read back through the SPI, disable the CRC by clearing the SPI\_CRC\_TEST\_EN bit. If the DOUTx interface is used, clear the DOUT\_HEADER\_FORMAT bit.

The error header provides information of common error sources specific for each channel, as shown in Table 36. Modulator and filter errors are indicated even if the checker for these errors are specifically disabled, as described in the Σ-Δ ADC Errors section.

Table 36. Status Header Output

Bits	Name	Description
7	Alert	This bit is set high if any of the enabled diagnostic functions have detected an error, including an external clock not detected, a memory map bit flip, or an internal CRC error. This bit is not channel specific. The bit clears if the error is no longer present.
[6:4]	CH_ID_[2:0]	These bits indicate which ADC channel the following conversion data came from (see Table 33).
3	RESET_DETECTED	This bit indicates if a reset condition occurs. This bit is not channel specific.
2	MODULATOR_SATURATE	This bit indicates that the modulator output is 20 consecutive 0s or 1s. The bit resets automatically after the error is no longer present.
1	FILTER_SATURATE	This bit indicates that the filter output is out of bounds. The bit resets automatically after the error is no longer present.
0	AIN_OV_UVERROR	This bit indicates that there is an AINx± overvoltage/undervoltage condition on the inputs. This bit is set until the appropriate register is read back and the error is no longer present.

## SRC (SPI CONTROL MODE)

The AD7770 implements a feature called the SRC on each  $\Sigma$ - $\Delta$  channel that allows the user to configure the output data rate or sampling frequency to any desired value, including noninteger values. The SRC achieves fine resolution control over the  $\Sigma$ - $\Delta$  ADC ODR. In applications where the ODR must change based on changes in the input signal to maintain sampling coherency, the SRC provides fine control over the ODR. For example, to achieve the highest classification standard, Class A, in power quality applications, coherency must be maintained for 0.01 Hz changes in the input power line. Use the SRC to achieve this sampling frequency accuracy.

In pin control mode, the decimation rate is fixed per the predefined pin control options. Consequently, a noninteger number cannot be selected, as shown in Table 13.

To set the ODR, the user must program up to four registers, depending on the decimation value: two registers to program the integer value, N (the effective decimation rate), and two registers to program the decimal value, the interpolation factor (IF).

The integer value registers are SRC\_N\_MSB, Bits[3:0] and SRC\_N\_LSB, Bits[7:0]. The decimal part value registers are SRC\_IF\_MSB, Bits[7:0] and SRC\_IF\_LSB, Bits[7:0].

As an example, if an output data rate of 2.8 kHz is required, the decimation rate equates to

- High resolution mode =  $2048/2.8 = 731.428$
- Low power mode =  $512/2.8 = 182.857$

The register values for high resolution mode are as follows:

- 731 (decimal) = 0x2DB
- SRC\_N\_MSB, Bits[3:0] = 0x02
- SRC\_N\_LSB, Bits[7:0] = 0xDB
- 0.428 (decimal) =  $0.428 \times 2^{16} = 28049$  (decimal) = 0x6D91
- SRC\_IF\_MSB, Bits[7:0] = 0x6D
- SRC\_IF\_LSB, Bits[7:0] = 0x91

The SRC resolution depends on the decimal number used in the decimation, as well as the modulator clock (MOD\_CLK), as follows:

$$Resolution = \frac{MOD_{MCLK}}{2^{16} \times DEC^2 + 3 \times DEC + 2 \times \frac{1}{2^{16}}}$$

where:

$MOD_{MCLK}$  is the modulator frequency.

DEC is the decimal portion of the decimation rate.

In high resolution mode, for a decimal decimation of 450, the resolution is defined as

$$\frac{2048}{2^{16} \times 450^2 + 3 \times 450^2 \times \frac{1}{2^{16}}} = 15.4 \times 10^{-6} \text{ SPS}$$

The ODR can be updated on-the-fly, but a new ODR is effective in three conversion cycles of the  $\Sigma$ - $\Delta$  ADCs. This condition guarantees a smooth transition with no conversion results out of range.

There are two different ways to change the ODR after a new value is written in the SRC registers: via software or via hardware, depending on SRC\_LOAD\_SOURCE (SRC\_UPDATE register, Bit 7).

If the SRC\_LOAD\_SOURCE bit is clear, the new ODR value is updated by setting the SRC\_LOAD\_UPDATE bit to 1. This bit must be held high for at least two MCLK periods; return the bit to 0 before attempting another update.

If SRC\_LOAD\_SOURCE is set, the GPIO0 pin controls the ODR update externally. Apply a pulse in the GPIO2 pin, which is then internally synchronized with the external MCLK clock, and the resultant synchronous signal is output on the GPIO1 pin.

The GPIO1 and GPIO0 pins must be externally connected.

If multiple AD7770 devices must be synchronized, the GPIO1 pin of one device can be connected to multiple devices. This synchronization method requires the use of a common MCLK signal for all the AD7770 devices connected, as shown in Figure 109.

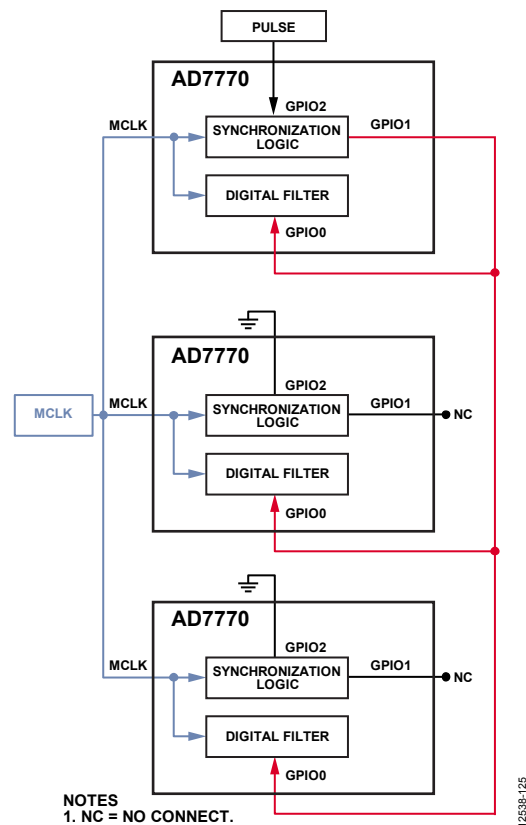

Figure 109. Hardware ODR Update

125394-125

**SRC Bandwidth**

The sinc3 filter architecture allows the user to select a noninteger value as the decimation range. This versatility means that the filter notches must be adjusted dynamically: two notches at the variable frequency, and one fixed notch to remove the PGA chopping tone. Consequently, the traditional formula for -0.1 dB and -3 dB bandwidth must be adjusted depending on the selected decimation rate.

The bandwidth transfer function is not linear but can be approximated by using a linear function.

Figure 110 and Figure 111 show the correction factor for the -0.1 dB and -3 dB bandwidth, respectively, in high resolution. In low power mode, the offset must be divided by 4. For example, when the ODR = 1000 SPS in low power mode, the -0.1 dB point is

$$BW = 0.0481 \times 1000 + \frac{47.36}{4} \approx 71 \text{ Hz}$$

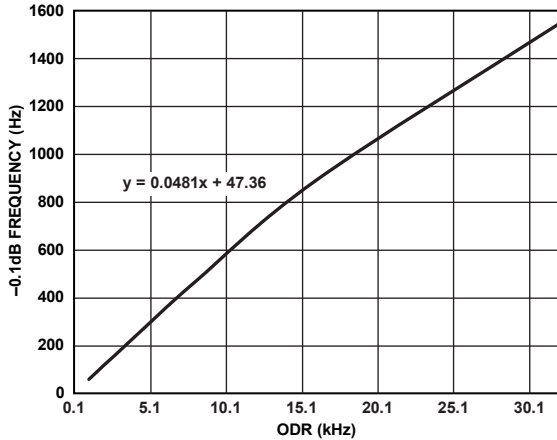

Figure 110. -0.1 dB Correction Factor

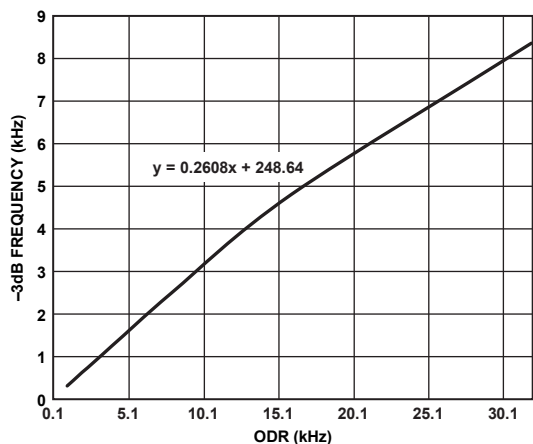

Figure 111. -3 dB Correction Factor

**SRC Group Delay and Latency**

The SRC group delay depends on the selected ODR and the power mode, and is defined by the following equation:

$$\text{Group delay} = \frac{PM + SRC\_N}{SRC\_N \times ODR}$$

where:

PM is a value that depends on the power mode, either 64 for high resolution mode or 32 for low power mode.

SRC\_N is the integer value of the programmed ODR.

ODR is the programmed output data rate.

The latency is the contribution of the group delay and the calibration time.

$$\text{Latency} = \text{Group delay} + t_{CAL}$$

where  $t_{CAL} = 62 \times t_{MCLK}$ , with a maximum error of  $2 \times t_{MCLK}$ , in high resolution mode; or  $121 \times t_{MCLK}$ , with a maximum error of  $4 \times t_{MCLK}$ , in low power mode.

$t_{MCLK}$  is the modulator period, MCLK/4 in high resolution mode and MCLK/8 in low power mode.

**Settling Time**

The settling time is defined by the contribution of all the internal stages, the filter delay, and the block calibration.

The filter delay is defined as  $3/ODR$ . In some extreme cases, as when an external pulse is applied, this value may increase to  $4/ODR$ .

**DATA OUTPUT INTERFACE**

The  $\Sigma$ - $\Delta$  output data interface is defined by the CONVST\_SAR, FORMAT0, and FORMAT1 pins in pin control mode at power-up. The FORMATx pins cannot be changed dynamically. Table 14 shows the available options for pin control mode. If the device is configured in SPI control mode, the SPI\_SLAVE\_MODE\_EN bit enables the SPI to transmit the  $\Sigma$ - $\Delta$  ADC conversion results, as shown in Table 23.

**DOUT3 to DOUT0 Data Interface**

**Standalone Mode**

In standalone mode, the AD7770 interface acts as a master. There are three different DOUTx configurations, configurable through the FORMATx pins in pin control mode, as shown in Figure 112 through Figure 114, or via the DOUT\_FORMAT bits, Bits[7:6], in SPI control mode, as described in Table 37.

Figure 115, Figure 116, and Figure 117 show the expected data outputs for different DOUTx output modes.

Table 37. DOUTx Channels

DOUT_FORMAT Bits/FORMATx Pins	Number of DOUTx Lines Enabled	Associated Channels
00	4	DOUT0—Channel 0 and Channel 1 DOUT1—Channel 2 and Channel 3 DOUT2—Channel 4 and Channel 5 DOUT3—Channel 6 and Channel 7
01	2	DOUT0—Channel 0, Channel 1, Channel 2, and Channel 3 DOUT1—Channel 4, Channel 5, Channel 6, and Channel 7
10 or 11	1	DOUT0—Channel 0, Channel 1, Channel 2, Channel 3, Channel 4, Channel 5, Channel 6, and Channel 7

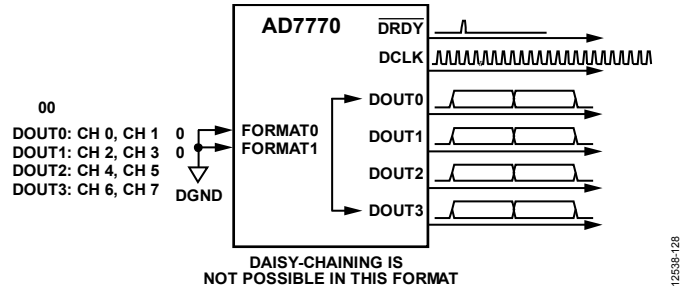

Figure 112. FORMATx Pin Configuration—FORMAT0 = 0, FORMAT1 = 0

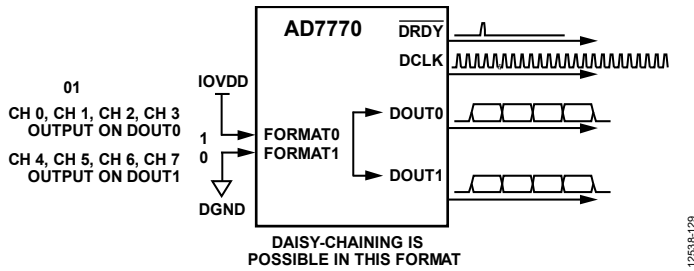

Figure 113. FORMATx Pin Configuration—FORMAT0 = 1, FORMAT1 = 0

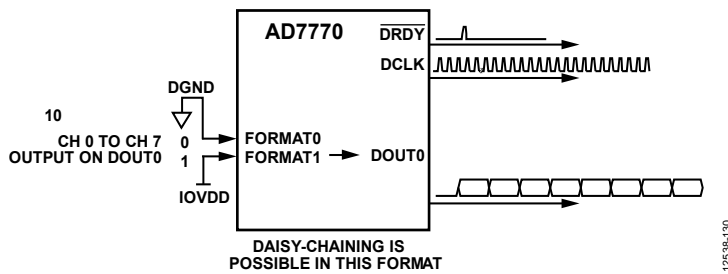

Figure 114. FORMATx Pin Configuration—FORMAT0 = 0, FORMAT1 = 1

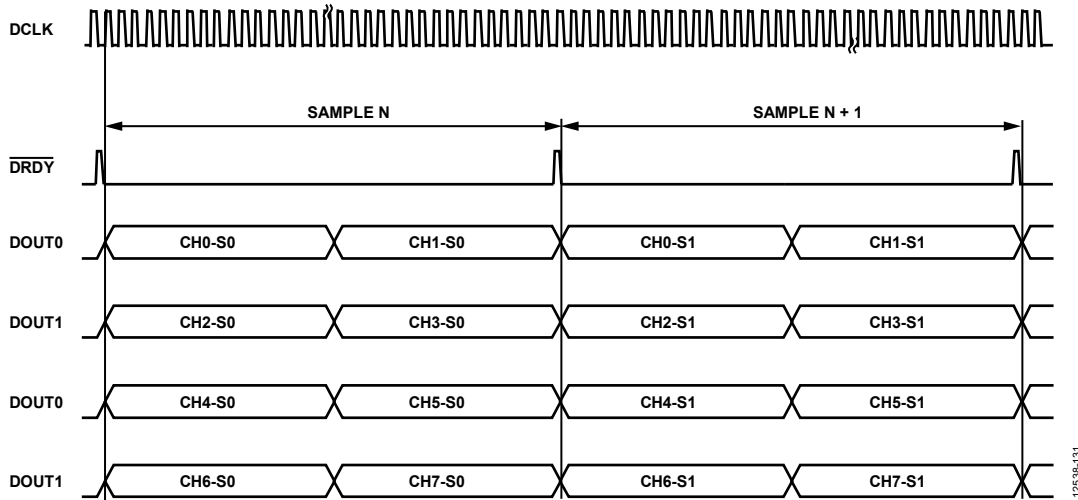

Figure 115.  $FORMAT0 = 0, FORMAT1 = 0$ —Each  $DOUTx$  Outputs Two ADC Conversions (S0 Means Sample 0 and S1 Means Sample 1)

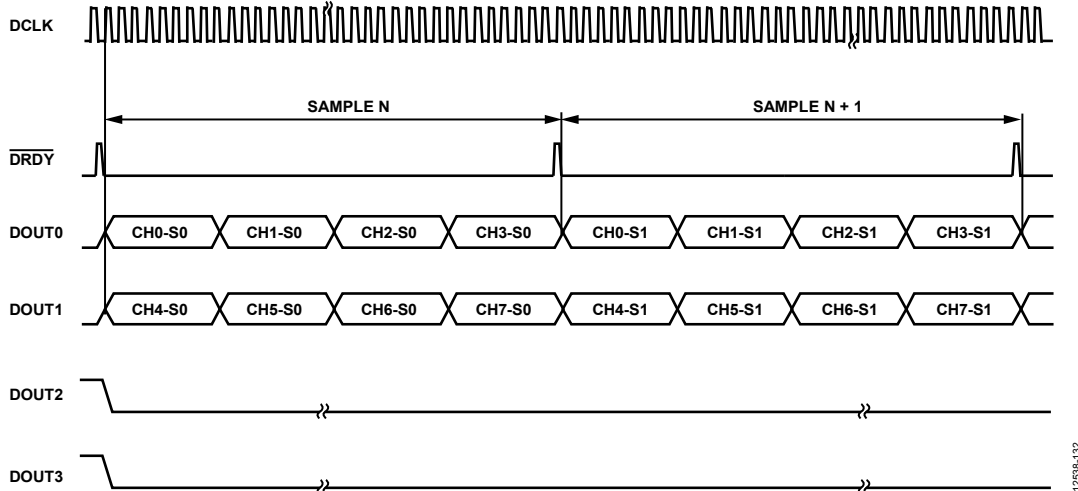

Figure 116.  $FORMAT0 = 0, FORMAT1 = 1$ —Channel 0 to Channel 3 Share  $DOUT0$ , and Channel 4 to Channel 7 Share  $DOUT1$  (S0 Means Sample 0 and S1 Means Sample 1)

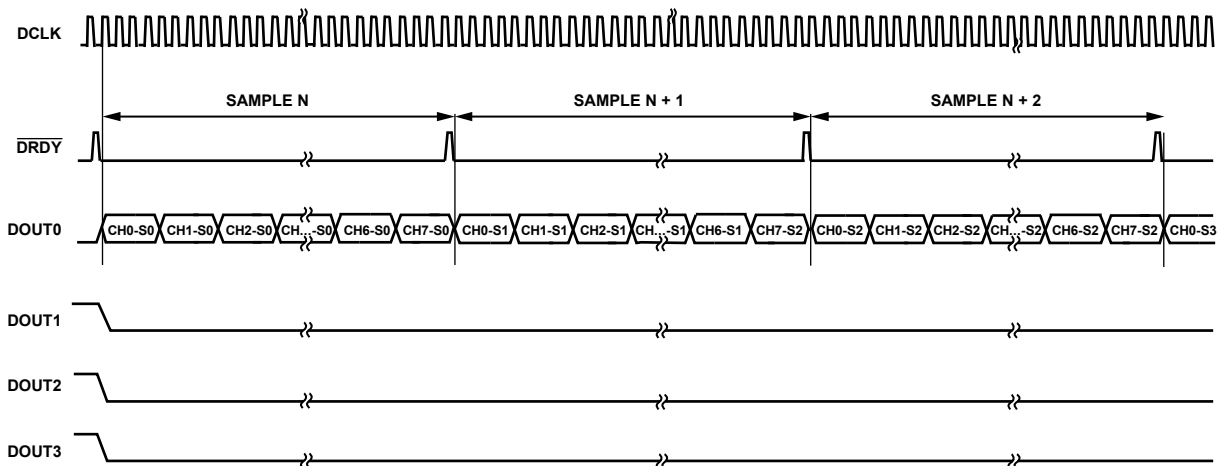

Figure 117.  $FORMAT0 = 1, FORMAT1 = 0$ —Channel 0 to Channel 7 Output on  $DOUT0$  Only (S0 Means Sample 0 and S1 Means Sample 1)



**Daisy-Chain Mode**

Daisy-chaining devices allows numerous devices to use the same data interface lines by cascading the outputs of multiple ADCs from separate AD7770 devices. In daisy-chain configuration, only one device has a direct connection between the DOUTx interface and the digital host. For the AD7770, daisy-chain capability is implemented by cascading DOUT0 and DOUT1 through a number of devices, or by just using DOUT0 (the number of DOUTx pins available depends on the selected DOUTx mode). The ability to daisy-chain devices and the limit on the number of devices that can be handled by the chain is dependent on the selected DOUTx mode and the decimation rate employed.

When operating in daisy-chain mode, it is required that all AD7770 devices in the chain are correctly synchronized. See the Digital Reset and Synchronization Pins section for more information.

This feature is especially useful for reducing the component count and wiring connections in, for example, isolated multiconverter applications or for systems with a limited interfacing capacity.

For daisy-chain operation, there are two different configurations possible, as described in Table 38.

Using the FORMATx = 10 mode, DOUT2 acts as an input pin, as shown in Figure 118. In this case, the DOUT0 pin of the AD7770 devices is cascaded to the DOUT2 pin of the next device in the chain. Data readback is analogous to clocking a shift register where data is clocked on the rising edge of DCLK.

**Table 38. DOUTx Modes in Daisy-Chain Operation**

DOUT_FORMAT Bits/ FORMATx Pins	Number of DOUTx Lines Enabled	Associated Channels
01	2	DOUT0—Channel 0 to Channel 3 and DOUT2 DOUT1—Channel 4 to Channel 7 and DOUT3 DOUT2—input channel DOUT3—input channel
10	1	DOUT0—Channel 0 to Channel 7 and DOUT2 DOUT2—input channel

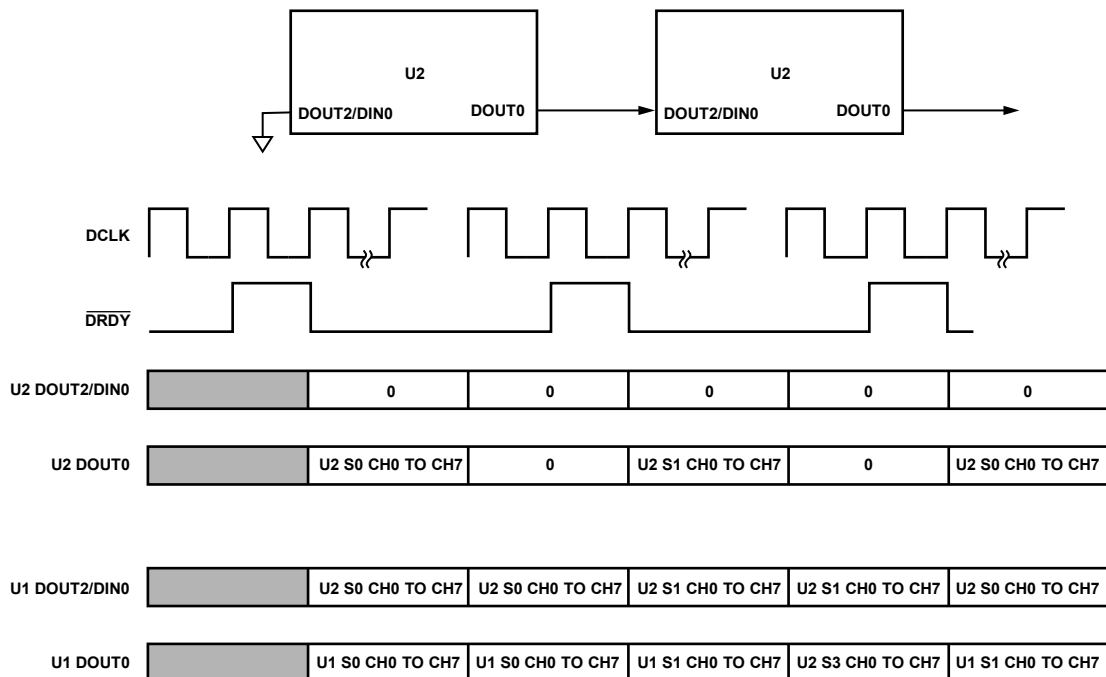

Figure 118. Daisy-Chain Connection Mode, FORMAT0 = 1, FORMAT1 = 0 (S0 Means Sample 0 and S1 Means Sample 1); When Connected in Daisy-Chain Mode, DOUT2 Acts as an Input Pin, Represented by DIN0

### Minimum DCLKx Frequency

Select the DCLKx frequency ratio in such a way that the data is completely shifted out before a new conversion is completed; otherwise the previous conversion is overwritten and the transmission becomes corrupt. The minimum DCLKx frequency ratio is defined by the decimation rate, the operation mode, and the lines enabled on the DOUT3 to DOUT0 data interfaces as described in the following equations.

In standalone mode and high resolution mode,

$$DCLK_{MIN\_RATIO} < Decimation / (8 \times CHANNELS\_PER\_DOUT)$$

In standalone mode and low power mode,

$$DCLK_{MIN\_RATIO} < Decimation / (4 \times CHANNELS\_PER\_DOUT)$$

In daisy-chain mode and high resolution mode,

$$DCLK_{MIN\_RATIO} < Decimation / (8 \times Devices \times DOUTx\ Channels)$$

In daisy-chain mode and low power mode,

$$DCLK_{MIN\_RATIO} < Decimation / (4 \times Devices \times DOUTx\ Channels)$$

As an example, when operating in master interface mode,  $FORMATx = 01$ , the DOUT0 and DOUT1 pins shift out four  $\Sigma$ - $\Delta$  channels each and, assuming a maximum output rate in high resolution mode, the decimation = 128.

$$DCLK_{MIN} < 128 / (8 \times 4) = 4$$

If the  $DCLK_{MIN\_RATIO}$  is selected above the necessary minimum, a Logic 0 is continuously transmitted until a new sample is available.

An example in daisy-chain mode, assuming  $FORMATx = 01$ , and with three devices connected and a decimation rate of 256 in high resolution mode, is as follows:

$$DCLK_{MIN\_RATIO} < 256 / (8 \times 3 \times 4) = 2.66 = 2$$

The different ratios are summarized in Table 39.

**Table 39. Available DCLK Ratios**

DCLK_CLK_DIV (SPI Control Mode), DCLKx (Pin Control Mode)	DCLKx Ratio
000	1
001	2
010	4
011	8
100	16
101	32
110	64
111	128

There are maximum achievable ODRs and minimum DCLKx frequencies required for a given DOUTx pin configuration, as shown in Table 40 and Table 41.

**Table 40. Maximum ODRs and Minimum DCLKx Frequencies in High Resolution Mode**

Decimation Rate	ODR (kSPS)	Minimum DCLKx (kHz)		
		1 × DOUTx	2 × DOUTx	4 × DOUTx
4095	0.500122	128	64	32
2048	1	256	128	64
1024	2	512	256	128
512	4	1024	512	256
256	8	2048	1024	512
128	16	4096	2048	1024
64	32	8192	4096	2048

**Table 41. Maximum ODRs and Minimum DCLKx Frequencies in Low Power Mode**

Decimation Rate	ODR (kSPS)	Minimum DCLKx (kHz)		
		1 × DOUTx	2 × DOUTx	4 × DOUTx
2048	0.25	64	32	16
1024	0.5	128	64	32
512	1	256	128	64
256	2	512	256	128
128	4	1024	512	256
64	8	2048	1024	512

If the AD7770 operates in SPI control mode, it is possible to adjust the DOUTx strength, which can be selected in the DOUT\_DRIVE\_STR bits, as described in Table 42.

**Table 42. DOUTx Strength**

DOUT_DRIVE_STR	Mode
00	Nominal
01	Strong
10	Weak
11	Extra strong

### SPI

The SPI gives the user flexibility to read the conversion from the  $\Sigma$ - $\Delta$  ADC where the processor or microcontroller is the master.

When a new conversion is completed, the  $\overline{DRDY}$  signal is toggled to indicate that data can be accessed. When  $\overline{DRDY}$  toggles, the internal channel counter is reset and the next SPI read originates from Channel 0 again. Conversely, after the last channel data is read, all successive reads before the next  $\overline{DRDY}$  signal originate from Channel 7 (LSB).

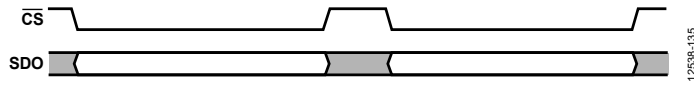

Figure 119. SPI Readback, 16 Bits per Frame



Figure 120. SPI Readback, 24 Bits per Frame

The SPI operates in multiples of 8 bits per frame; Figure 119 shows a readback example in 16 bits per frames, and Figure 120 shows a readback in 24 bits per frame.

Note that if the device is configured in SPI control mode, the AD7770 generates a software reset if the SDI pin is sampled high for 64 consecutive clocks. To avoid a reset or unwanted register writes, it is recommended to transfer a 0x8000 command, which generates a readback command that is ignored by the device, as explained in the  $\Sigma$ - $\Delta$  Data, ADC Mode section.

CALCULATING THE CRC CHECKSUM

The AD7770 implements two different CRC checksum generators, one for the  $\Sigma$ - $\Delta$  results and another for the SPI control mode.

The AD7770 uses a CRC polynomial to calculate the CRC checksum value. The 8-bit CRC polynomial used is  $x^8 + x^2 + x + 1$ .

To replicate the polynomial division in hardware, remember that the data is left shifted by eight bits to create a number ending in eight Logic 0s. The polynomial is aligned so that its MSB is adjacent to the leftmost Logic 1 of the data. An exclusive OR (XOR) function is applied to the data to produce a new, shorter number. The polynomial is again aligned so that its MSB is adjacent to the leftmost Logic 1 of the new result, and the procedure is repeated. This process is repeated until the original data is reduced to a value less than the polynomial, the 8-bit checksum.

Note that the AD7770 CRC block preset the input shift registers to 1, meaning that the 8 MSBs of user data must be inverted before compute the algorithm.

An example of the CRC calculation for 12-bit data is shown in Table 43.

Table 43. Example CRC Calculation for 12-Bit Data<sup>1</sup>

Data	0	0	0	0	0	1	1	0	0	1	0	0	1	1	1	0	0	0	0	0	0	0	0	0	0	0	0	0	0	0	0	
Process Data	1	1	1	1	1	0	0	1	0	1	0	0	1	1	1	0	0	0	0	0	0	0	0	0	0	0	0	0	0	0	0	
Polynomial	1	0	0	0	0	0	1	1	1																							
		1	1	1	1	0	1	0	1	1																						
		1	0	0	0	0	0	1	1	1																						
			1	1	1	0	1	1	0	0	0																					
			1	0	0	0	0	0	1	1	1																					
				1	1	0	1	1	1	1	1	0																				
				1	0	0	0	0	0	1	1	1																				
					1	0	1	1	1	0	0	1	1																			
						1	0	0	0	0	0	1	1	1																		
							1	1	0	1	0	0	1	0	0																	
								1	0	0	0	0	1	0	0	0																
									1	0	1	0	1	0	0	0																
										1	0	1	1	0	0	1	0															
											1	0	0	0	0	0	1	0														
												1	0	0	0	0	0	1	1													
													1	0	0	0	0	0	1	1	0											
														1	0	0	0	0	0	1	1	0	0									
															1	0	0	0	0	0	1	1	1	0								
																1	0	0	0	0	0	0	1	1	0							
																	1	0	0	0	0	0	0	1	1	0						
																		1	0	0	0	0	0	0	1	1	0					
																			1	0	0	0	0	0	0	1	1	0				
																				1	0	0	0	0	0	0	1	1	0			
																					1	0	0	0	0	0	0	1	1	0		
																						1	0	0	0	0	0	0	1	0		
																							1	0	0	0	0	0	0	0	0	
CRC																								0	1	0	0	0	0	1	0	0

<sup>1</sup> This table represents the division of the data; blank cells are for formatting purposes.

**$\Sigma$ - $\Delta$  CRC Checksum**

The CRC message is calculated internally by the AD7770 on ADC pairs. The CRC is calculated using the ADC output data from two ADCs and Bits[7:4] from the header. Therefore, 56 bits are used to calculate the 8-bit CRC. This CRC is split between the two channel headers. The CRC data covers channel pairings as follows: Channel 0 and Channel 1, Channel 2 and Channel 3, Channel 4 and Channel 5, Channel 6, and Channel 7.

To generate the checksum, the data is left shifted by eight bits to create a number ending in eight Logic 1s.

The CRC is calculated from 56 bits across two consecutive/ channel pairings (Channel 0 and Channel 1, Channel 2 and Channel 3, Channel 4 and Channel 5, Channel 6, and Channel 7). The 56 bits consist of the alert bit, the 3 bits for the first ADC pairing channel, and the 24 bits of data of each pairing channel. For example, for the second channel pairing, Channel 2 and Channel 3,

56 bits = *alert bit* + 3 ADC channel bits (010) + 24 data bits (Channel 2) + *alert bit* + 3 ADC channel bits (011) + 24 data bits (Channel 3)

**SPI Control Mode Checksum**

The CRC message is calculated internally by the AD7770. The data transferred to the AD7770 uses the R/W bit, a 7-bit address, and 8 bits of data for the CRC calculation.

The CRC calculated and appended to the data that it is shifted out uses the previous transmitted R/ $\overline{W}$  bit, the 7-bit register address, and the 8-bit data from the readback register. If the previous command was a write command, the 8 bits of data are 0s.

If the SAR ADC is read back, the CRC algorithm uses a 0000b header and the 12 bits of SAR conversion data.

## REGISTER SUMMARY

Table 44. Register Summary

Reg.	Name	Bits	Bit 7	Bit 6	Bit 5	Bit 4	Bit 3	Bit 2	Bit 1	Bit 0	Reset	R/W	
0x000	CH0_CONFIG	[7:0]	CH0_GAIN		CH0_REF_MONITOR	CH0_RX	RESERVED				0x00	R/W	
0x001	CH1_CONFIG	[7:0]	CH1_GAIN		CH1_REF_MONITOR	CH1_RX	RESERVED				0x00	R/W	
0x002	CH2_CONFIG	[7:0]	CH2_GAIN		CH2_REF_MONITOR	CH2_RX	RESERVED				0x00	R/W	
0x003	CH3_CONFIG	[7:0]	CH3_GAIN		CH3_REF_MONITOR	CH3_RX	RESERVED				0x00	R/W	
0x004	CH4_CONFIG	[7:0]	CH4_GAIN		CH4_REF_MONITOR	CH4_RX	RESERVED				0x00	R/W	
0x005	CH5_CONFIG	[7:0]	CH5_GAIN		CH5_REF_MONITOR	CH5_RX	RESERVED				0x00	R/W	
0x006	CH6_CONFIG	[7:0]	CH6_GAIN		CH6_REF_MONITOR	CH6_RX	RESERVED				0x00	R/W	
0x007	CH7_CONFIG	[7:0]	CH7_GAIN		CH7_REF_MONITOR	CH7_RX	RESERVED				0x00	R/W	
0x008	CH_DISABLE	[7:0]	CH7_DISABLE	CH6_DISABLE	CH5_DISABLE	CH4_DISABLE	CH3_DISABLE	CH2_DISABLE	CH1_DISABLE	CH0_DISABLE	0x00	R/W	
0x009	CH0_SYNC_OFFSET	[7:0]	CH0_SYNC_OFFSET									0x00	R/W
0x00A	CH1_SYNC_OFFSET	[7:0]	CH1_SYNC_OFFSET									0x00	R/W
0x00B	CH2_SYNC_OFFSET	[7:0]	CH2_SYNC_OFFSET									0x00	R/W
0x00C	CH3_SYNC_OFFSET	[7:0]	CH3_SYNC_OFFSET									0x00	R/W
0x00D	CH4_SYNC_OFFSET	[7:0]	CH4_SYNC_OFFSET									0x00	R/W
0x00E	CH5_SYNC_OFFSET	[7:0]	CH5_SYNC_OFFSET									0x00	R/W
0x00F	CH6_SYNC_OFFSET	[7:0]	CH6_SYNC_OFFSET									0x00	R/W
0x010	CH7_SYNC_OFFSET	[7:0]	CH7_SYNC_OFFSET									0x00	R/W
0x011	GENERAL_USER_CONFIG_1	[7:0]	ALL_CH_DIS_MCLK_EN	POWERMODE	PDB_VCM	PDB_REFOUT_BUF	PDB_SAR	PDB_RC_OSC	SOFT_RESET		0x24	R/W	
0x012	GENERAL_USER_CONFIG_2	[7:0]	RESERVED		SAR_DIAG_MODE_EN	SDO_DRIVE_STR		DOUT_DRIVE_STR		SPI_SYNC	0x09	R/W	
0x013	GENERAL_USER_CONFIG_3	[7:0]	CONVST_DEGLITCH_DIS		RESERVED	SPI_SLAVE_MODE_EN	RESERVED			CLK_QUAL_DIS	0x80	R/W	
0x014	DOUT_FORMAT	[7:0]	DOUT_FORMAT		DOUT_HEADER_FORMAT	RESERVED	DCLK_CLK_DIV			RESERVED	0x20	R/W	
0x015	ADC_MUX_CONFIG	[7:0]	REF_MUX_CTRL		MTR_MUX_CTRL				RESERVED		0x00	R/W	
0x016	GLOBAL_MUX_CONFIG	[7:0]	GLOBAL_MUX_CTRL					RESERVED				0x00	R/W
0x017	GPIO_CONFIG	[7:0]	RESERVED					GPIO_OP_EN				0x00	R/W
0x018	GPIO_DATA	[7:0]	RESERVED		GPIO_READ_DATA			GPIO_WRITE_DATA			0x00	R/W	
0x019	BUFFER_CONFIG_1	[7:0]	RESERVED			REF_BUF_POS_EN	REF_BUF_NEG_EN	RESERVED				0x38	R/W
0x01A	BUFFER_CONFIG_2	[7:0]	REF-BUFP_PREQ	REF-BUFN_PREQ	RESERVED			PDB_ALDO1_OVRDRV	PDB_ALDO2_OVRDRV	PDB_DLDO_OVRDRV	0xC0	R/W	
0x01C	CH0_OFFSET_UPPER_BYTE	[7:0]	CH0_OFFSET_ALL[23:16]									0x00	R/W
0x01D	CH0_OFFSET_MID_BYTE	[7:0]	CH0_OFFSET_ALL[15:8]									0x00	R/W
0x01E	CH0_OFFSET_LOWER_BYTE	[7:0]	CH0_OFFSET_ALL[7:0]									0x00	R/W

Reg.	Name	Bits	Bit 7	Bit 6	Bit 5	Bit 4	Bit 3	Bit 2	Bit 1	Bit 0	Reset	R/W	
0x01F	CH0_GAIN_UPPER_BYTE	[7:0]				CH0_GAIN_ALL[23:16]						0x00	R/W
0x020	CH0_GAIN_MID_BYTE	[7:0]				CH0_GAIN_ALL[15:8]						0x00	R/W
0x021	CH0_GAIN_LOWER_BYTE	[7:0]				CH0_GAIN_ALL[7:0]						0x00	R/W
0x022	CH1_OFFSET_UPPER_BYTE	[7:0]				CH1_OFFSET_ALL[23:16]						0x00	R/W
0x023	CH1_OFFSET_MID_BYTE	[7:0]				CH1_OFFSET_ALL[15:8]						0x00	R/W
0x024	CH1_OFFSET_LOWER_BYTE	[7:0]				CH1_OFFSET_ALL[7:0]						0x00	R/W
0x025	CH1_GAIN_UPPER_BYTE	[7:0]				CH1_GAIN_ALL[23:16]						0x00	R/W
0x026	CH1_GAIN_MID_BYTE	[7:0]				CH1_GAIN_ALL[15:8]						0x00	R/W
0x027	CH1_GAIN_LOWER_BYTE	[7:0]				CH1_GAIN_ALL[7:0]						0x00	R/W
0x028	CH2_OFFSET_UPPER_BYTE	[7:0]				CH2_OFFSET_ALL[23:16]						0x00	R/W
0x029	CH2_OFFSET_MID_BYTE	[7:0]				CH2_OFFSET_ALL[15:8]						0x00	R/W
0x02A	CH2_OFFSET_LOWER_BYTE	[7:0]				CH2_OFFSET_ALL[7:0]						0x00	R/W
0x02B	CH2_GAIN_UPPER_BYTE	[7:0]				CH2_GAIN_ALL[23:16]						0x00	R/W
0x02C	CH2_GAIN_MID_BYTE	[7:0]				CH2_GAIN_ALL[15:8]						0x00	R/W
0x02D	CH2_GAIN_LOWER_BYTE	[7:0]				CH2_GAIN_ALL[7:0]						0x00	R/W
0x02E	CH3_OFFSET_UPPER_BYTE	[7:0]				CH3_OFFSET_ALL[23:16]						0x00	R/W
0x02F	CH3_OFFSET_MID_BYTE	[7:0]				CH3_OFFSET_ALL[15:8]						0x00	R/W
0x030	CH3_OFFSET_LOWER_BYTE	[7:0]				CH3_OFFSET_ALL[7:0]						0x00	R/W
0x031	CH3_GAIN_UPPER_BYTE	[7:0]				CH3_GAIN_ALL[23:16]						0x00	R/W
0x032	CH3_GAIN_MID_BYTE	[7:0]				CH3_GAIN_ALL[15:8]						0x00	R/W
0x033	CH3_GAIN_LOWER_BYTE	[7:0]				CH3_GAIN_ALL[7:0]						0x00	R/W
0x034	CH4_OFFSET_UPPER_BYTE	[7:0]				CH4_OFFSET_ALL[23:16]						0x00	R/W
0x035	CH4_OFFSET_MID_BYTE	[7:0]				CH4_OFFSET_ALL[15:8]						0x00	R/W
0x036	CH4_OFFSET_LOWER_BYTE	[7:0]				CH4_OFFSET_ALL[7:0]						0x00	R/W
0x037	CH4_GAIN_UPPER_BYTE	[7:0]				CH4_GAIN_ALL[23:16]						0x00	R/W
0x038	CH4_GAIN_MID_BYTE	[7:0]				CH4_GAIN_ALL[15:8]						0x00	R/W
0x039	CH4_GAIN_LOWER_BYTE	[7:0]				CH4_GAIN_ALL[7:0]						0x00	R/W
0x03A	CH5_OFFSET_UPPER_BYTE	[7:0]				CH5_OFFSET_ALL[23:16]						0x00	R/W
0x03B	CH5_OFFSET_MID_BYTE	[7:0]				CH5_OFFSET_ALL[15:8]						0x00	R/W
0x03C	CH5_OFFSET_LOWER_BYTE	[7:0]				CH5_OFFSET_ALL[7:0]						0x00	R/W
0x03D	CH5_GAIN_UPPER_BYTE	[7:0]				CH5_GAIN_ALL[23:16]						0x00	R/W
0x03E	CH5_GAIN_MID_BYTE	[7:0]				CH5_GAIN_ALL[15:8]						0x00	R/W
0x03F	CH5_GAIN_LOWER_BYTE	[7:0]				CH5_GAIN_ALL[7:0]						0x00	R/W

Reg.	Name	Bits	Bit 7	Bit 6	Bit 5	Bit 4	Bit 3	Bit 2	Bit 1	Bit 0	Reset	R/W
0x040	CH6_OFFSET_UPPER_BYTE	[7:0]	CH6_OFFSET_ALL[23:16]								0x00	R/W
0x041	CH6_OFFSET_MID_BYTE	[7:0]	CH6_OFFSET_ALL[15:8]								0x00	R/W
0x042	CH6_OFFSET_LOWER_BYTE	[7:0]	CH6_OFFSET_ALL[7:0]								0x00	R/W
0x043	CH6_GAIN_UPPER_BYTE	[7:0]	CH6_GAIN_ALL[23:16]								0x00	R/W
0x044	CH6_GAIN_MID_BYTE	[7:0]	CH6_GAIN_ALL[15:8]								0x00	R/W
0x045	CH6_GAIN_LOWER_BYTE	[7:0]	CH6_GAIN_ALL[7:0]								0x00	R/W
0x046	CH7_OFFSET_UPPER_BYTE	[7:0]	CH7_OFFSET_ALL[23:16]								0x00	R/W
0x047	CH7_OFFSET_MID_BYTE	[7:0]	CH7_OFFSET_ALL[15:8]								0x00	R/W
0x048	CH7_OFFSET_LOWER_BYTE	[7:0]	CH7_OFFSET_ALL[7:0]								0x00	R/W
0x049	CH7_GAIN_UPPER_BYTE	[7:0]	CH7_GAIN_ALL[23:16]								0x00	R/W
0x04A	CH7_GAIN_MID_BYTE	[7:0]	CH7_GAIN_ALL[15:8]								0x00	R/W
0x04B	CH7_GAIN_LOWER_BYTE	[7:0]	CH7_GAIN_ALL[7:0]								0x00	R/W
0x04C	CH0_ERR_REG	[7:0]	RESERVED			CH0_ERR_AINM_UV	CH0_ERR_AINM_OV	CH0_ERR_AINP_UV	CH0_ERR_AINP_OV	CH0_ERR_REF_DET	0x00	R
0x04D	CH1_ERR_REG	[7:0]	RESERVED			CH1_ERR_AINM_UV	CH1_ERR_AINM_OV	CH1_ERR_AINP_UV	CH1_ERR_AINP_OV	CH1_ERR_REF_DET	0x00	R
0x04E	CH2_ERR_REG	[7:0]	RESERVED			CH2_ERR_AINM_UV	CH2_ERR_AINM_OV	CH2_ERR_AINP_UV	CH2_ERR_AINP_OV	CH2_ERR_REF_DET	0x00	R
0x04F	CH3_ERR_REG	[7:0]	RESERVED			CH3_ERR_AINM_UV	CH3_ERR_AINM_OV	CH3_ERR_AINP_UV	CH3_ERR_AINP_OV	CH3_ERR_REF_DET	0x00	R
0x050	CH4_ERR_REG	[7:0]	RESERVED			CH4_ERR_AINM_UV	CH4_ERR_AINM_OV	CH4_ERR_AINP_UV	CH4_ERR_AINP_OV	CH4_ERR_REF_DET	0x00	R
0x051	CH5_ERR_REG	[7:0]	RESERVED			CH5_ERR_AINM_UV	CH5_ERR_AINM_OV	CH5_ERR_AINP_UV	CH5_ERR_AINP_OV	CH5_ERR_REF_DET	0x00	R
0x052	CH6_ERR_REG	[7:0]	RESERVED			CH6_ERR_AINM_UV	CH6_ERR_AINM_OV	CH6_ERR_AINP_UV	CH6_ERR_AINP_OV	CH6_ERR_REF_DET	0x00	R
0x053	CH7_ERR_REG	[7:0]	RESERVED			CH7_ERR_AINM_UV	CH7_ERR_AINM_OV	CH7_ERR_AINP_UV	CH7_ERR_AINP_OV	CH7_ERR_REF_DET	0x00	R
0x054	CH0_1_SAT_ERR	[7:0]	RESERVED	CH1_ERR_MOD_SAT	CH1_ERR_FILTER_SAT	CH1_ERR_OUTPUT_SAT	CH0_ERR_MOD_SAT	CH0_ERR_FILTER_SAT	CH0_ERR_OUTPUT_SAT	0x00	R	
0x055	CH2_3_SAT_ERR	[7:0]	RESERVED	CH3_ERR_MOD_SAT	CH3_ERR_FILTER_SAT	CH3_ERR_OUTPUT_SAT	CH2_ERR_MOD_SAT	CH2_ERR_FILTER_SAT	CH2_ERR_OUTPUT_SAT	0x00	R	
0x056	CH4_5_SAT_ERR	[7:0]	RESERVED	CH5_ERR_MOD_SAT	CH5_ERR_FILTER_SAT	CH5_ERR_OUTPUT_SAT	CH4_ERR_MOD_SAT	CH4_ERR_FILTER_SAT	CH4_ERR_OUTPUT_SAT	0x00	R	
0x057	CH6_7_SAT_ERR	[7:0]	RESERVED	CH7_ERR_MOD_SAT	CH7_ERR_FILTER_SAT	CH7_ERR_OUTPUT_SAT	CH6_ERR_MOD_SAT	CH6_ERR_FILTER_SAT	CH6_ERR_OUTPUT_SAT	0x00	R	
0x058	CHX_ERR_REG_EN	[7:0]	OUTPUT_SAT_TEST_EN	FILTER_SAT_TEST_EN	MOD_SAT_TEST_EN	AINM_UV_TEST_EN	AINM_OV_TEST_EN	AINP_UV_TEST_EN	AINP_OV_TEST_EN	REF_DET_TEST_EN	0xFE	R/W
0x059	GEN_ERR_REG_1	[7:0]	RESERVED		MEMMAP_CRC_ERR	ROM_CRC_ERR	SPI_CLK_COUNT_ERR	SPI_INVALID_READ_ERR	SPI_INVALID_WRITE_ERR	SPI_CRC_ERR	0x00	R
0x05A	GEN_ERR_REG_1_EN	[7:0]	RESERVED		MEMMAP_CRC_TEST_EN	ROM_CRC_TEST_EN	SPI_CLK_COUNT_TEST_EN	SPI_INVALID_READ_TEST_EN	SPI_INVALID_WRITE_TEST_EN	SPI_CRC_TEST_EN	0x3E	R/W
0x05B	GEN_ERR_REG_2	[7:0]	RESERVED		RESET_DETECTED	EXT_MCLK_SWITCH_ERR	RE-SERVED	ALDO1_PSM_ERR	ALDO2_PSM_ERR	DLDO_PSM_ERR	0x00	R
0x05C	GEN_ERR_REG_2_EN	[7:0]	RESERVED		RESET_DETECT_EN	RESERVED	LDO_PSM_TEST_EN	LDO_PSM_TRIP_TEST_EN		0x3C	R/W	
0x05D	STATUS_REG_1	[7:0]	RESERVED		CHIP_ERROR	ERR_LOC_CH4	ERR_LOC_CH3	ERR_LOC_CH2	ERR_LOC_CH1	ERR_LOC_CH0	0x00	R

Reg.	Name	Bits	Bit 7	Bit 6	Bit 5	Bit 4	Bit 3	Bit 2	Bit 1	Bit 0	Reset	R/W	
0x05E	STATUS_REG_2	[7:0]	RESERVED		CHIP_ERROR	ERR_LOC_GEN2	ERR_LOC_GEN1	ERR_LOC_CH7	ERR_LOC_CH6	ERR_LOC_CH5	0x00	R	
0x05F	STATUS_REG_3	[7:0]	RESERVED		CHIP_ERROR	INIT_COMPLETE	ERR_LOC_SAT_CH6_7	ERR_LOC_SAT_CH4_5	ERR_LOC_SAT_CH2_3	ERR_LOC_SAT_CH0_1	0x00	R	
0x060	SRC_N_MSB	[7:0]	RESERVED				SRC_N_ALL[11:8]					0x00	R/W
0x061	SRC_N_LSB	[7:0]	SRC_N_ALL[7:0]								0x80	R/W	
0x062	SRC_IF_MSB	[7:0]	SRC_IF_ALL[15:8]									0x00	R/W
0x063	SRC_IF_LSB	[7:0]	SRC_IF_ALL[7:0]									0x00	R/W
0x064	SRC_UPDATE	[7:0]	SRC_LOAD_SOURCE	RESERVED						SRC_LOAD_UPDATE	0x00	R/W	



## REGISTER DETAILS

## CHANNEL 0 CONFIGURATION REGISTER

Address: 0x000, Reset: 0x00, Name: CH0\_CONFIG

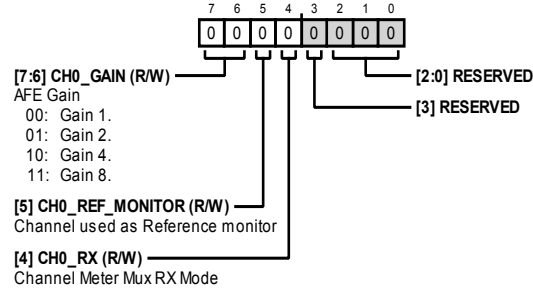

Table 45. Bit Descriptions for CH0\_CONFIG

Bits	Bit Name	Settings	Description	Reset	Access
[7:6]	CH0_GAIN	00 01 10 11	AFE Gain Gain = 1 Gain = 2 Gain = 4 Gain = 8	0x0	R/W
5	CH0_REF_MONITOR		Channel Used as Reference Monitor	0x0	R/W
4	CH0_RX		Channel Meter Mux Rx Mode	0x0	R/W
[3:0]	RESERVED		Reserved	0x0	R/W

## CHANNEL 1 CONFIGURATION REGISTER

Address: 0x001, Reset: 0x00, Name: CH1\_CONFIG

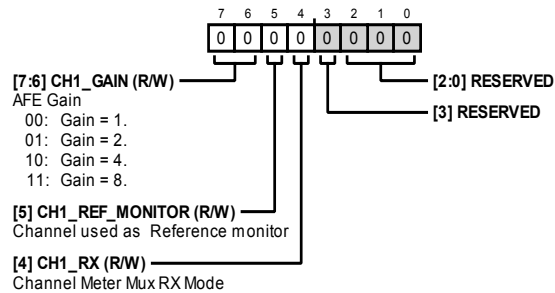

Table 46. Bit Descriptions for CH1\_CONFIG

Bits	Bit Name	Settings	Description	Reset	Access
[7:6]	CH1_GAIN	00 01 10 11	AFE Gain Gain = 1 Gain = 2 Gain = 4 Gain = 8	0x0	R/W
5	CH1_REF_MONITOR		Channel Used as Reference Monitor	0x0	R/W
4	CH1_RX		Channel Meter Mux Rx Mode	0x0	R/W
[3:0]	RESERVED		Reserved	0x0	R/W

**CHANNEL 2 CONFIGURATION REGISTER**

Address: 0x002, Reset: 0x00, Name: CH2\_CONFIG

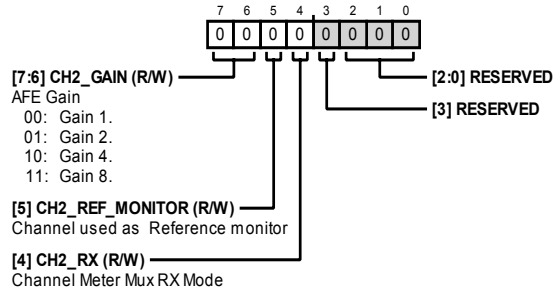

Table 47. Bit Descriptions for CH2\_CONFIG

Bits	Bit Name	Settings	Description	Reset	Access
[7:6]	CH2_GAIN	00 01 10 11	AFE Gain Gain = 1 Gain = 2 Gain = 4 Gain = 8	0x0	R/W
5	CH2_REF_MONITOR		Channel Used as Reference Monitor	0x0	R/W
4	CH2_RX		Channel Meter Mux Rx Mode	0x0	R/W
[3:0]	RESERVED		Reserved	0x0	R/W

**CHANNEL 3 CONFIGURATION REGISTER**

Address: 0x003, Reset: 0x00, Name: CH3\_CONFIG

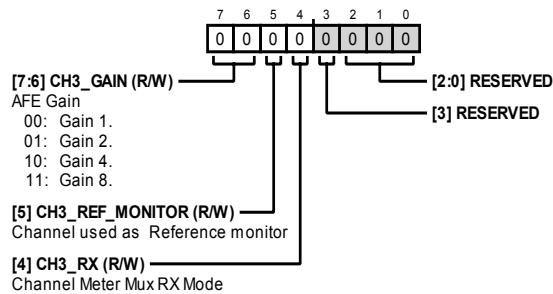

Table 48. Bit Descriptions for CH3\_CONFIG

Bits	Bit Name	Settings	Description	Reset	Access
[7:6]	CH3_GAIN	00 01 10 11	AFE Gain Gain = 1 Gain = 2 Gain = 4 Gain = 8	0x0	R/W
5	CH3_REF_MONITOR		Channel Used as Reference Monitor	0x0	R/W
4	CH3_RX		Channel Meter Mux Rx Mode	0x0	R/W
[3:0]	RESERVED		Reserved	0x0	R/W

**CHANNEL 4 CONFIGURATION REGISTER**

Address: 0x004, Reset: 0x00, Name: CH4\_CONFIG

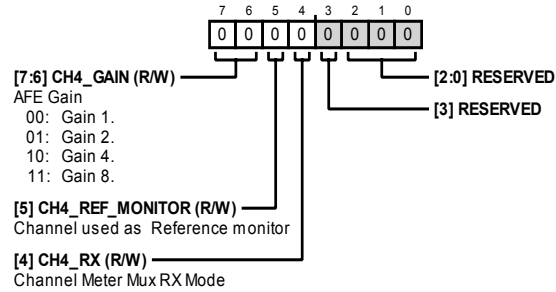

Table 49. Bit Descriptions for CH4\_CONFIG

Bits	Bit Name	Settings	Description	Reset	Access
[7:6]	CH4_GAIN	00 01 10 11	AFE Gain Gain = 1 Gain = 2 Gain = 4 Gain = 8	0x0	R/W
5	CH4_REF_MONITOR		Channel Used as Reference Monitor	0x0	R/W
4	CH4_RX		Channel Meter Mux Rx Mode	0x0	R/W
[3:0]	RESERVED		Reserved	0x0	R/W

**CHANNEL 5 CONFIGURATION REGISTER**

Address: 0x005, Reset: 0x00, Name: CH5\_CONFIG

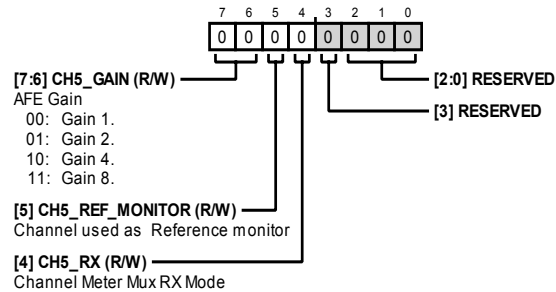

Table 50. Bit Descriptions for CH5\_CONFIG

Bits	Bit Name	Settings	Description	Reset	Access
[7:6]	CH5_GAIN	00 01 10 11	AFE Gain Gain = 1 Gain = 2 Gain = 4 Gain = 8	0x0	R/W
5	CH5_REF_MONITOR		Channel Used as Reference Monitor	0x0	R/W
4	CH5_RX		Channel Meter Mux Rx Mode	0x0	R/W
[3:0]	RESERVED		Reserved	0x0	R/W

**CHANNEL 6 CONFIGURATION REGISTER**

Address: 0x006, Reset: 0x00, Name: CH6\_CONFIG

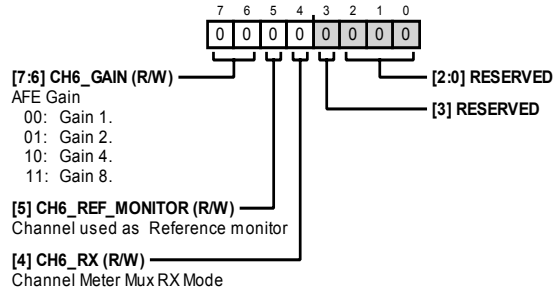

Table 51. Bit Descriptions for CH6\_CONFIG

Bits	Bit Name	Settings	Description	Reset	Access
[7:6]	CH6_GAIN	00 01 10 11	AFE Gain Gain = 1 Gain = 2 Gain = 4 Gain = 8	0x0	R/W
5	CH6_REF_MONITOR		Channel Used as Reference Monitor	0x0	R/W
4	CH6_RX		Channel Meter Mux Rx Mode	0x0	R/W
[3:0]	RESERVED		Reserved	0x0	R/W

**CHANNEL 7 CONFIGURATION REGISTER**

Address: 0x007, Reset: 0x00, Name: CH7\_CONFIG

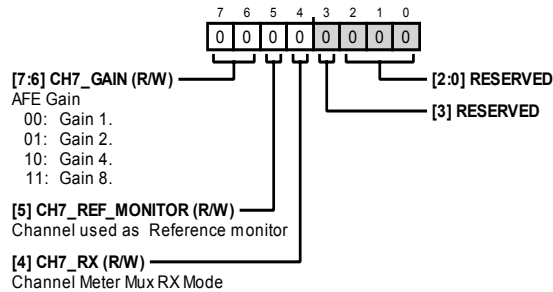

Table 52. Bit Descriptions for CH7\_CONFIG

Bits	Bit Name	Settings	Description	Reset	Access
[7:6]	CH7_GAIN	00 01 10 11	AFE Gain Gain = 1 Gain = 2 Gain = 4 Gain = 8	0x0	R/W
5	CH7_REF_MONITOR		Channel Used as Reference Monitor	0x0	R/W
4	CH7_RX		Channel Meter Mux Rx Mode	0x0	R/W
[3:0]	RESERVED		Reserved	0x0	R/W

**DISABLE CLOCKS TO ADC CHANNEL REGISTER**

Address: 0x008, Reset: 0x00, Name: CH\_DISABLE

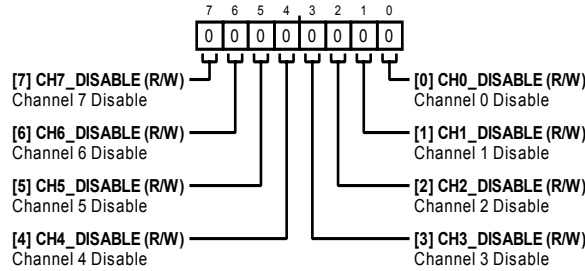

Table 53. Bit Descriptions for CH\_DISABLE

Bits	Bit Name	Settings	Description	Reset	Access
7	CH7_DISABLE		Channel 7 Disable	0x0	R/W
6	CH6_DISABLE		Channel 6 Disable	0x0	R/W
5	CH5_DISABLE		Channel 5 Disable	0x0	R/W
4	CH4_DISABLE		Channel 4 Disable	0x0	R/W
3	CH3_DISABLE		Channel 3 Disable	0x0	R/W
2	CH2_DISABLE		Channel 2 Disable	0x0	R/W
1	CH1_DISABLE		Channel 1 Disable	0x0	R/W
0	CH0_DISABLE		Channel 0 Disable	0x0	R/W

**CHANNEL 0 SYNC OFFSET REGISTER**

Address: 0x009, Reset: 0x00, Name: CH0\_SYNC\_OFFSET

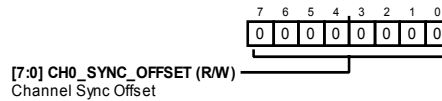

Table 54. Bit Descriptions for CH0\_SYNC\_OFFSET

Bits	Bit Name	Settings	Description	Reset	Access
[7:0]	CH0_SYNC_OFFSET		Channel Sync Offset	0x0	R/W

**CHANNEL 1 SYNC OFFSET REGISTER**

Address: 0x00A, Reset: 0x00, Name: CH1\_SYNC\_OFFSET

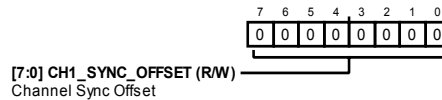

Table 55. Bit Descriptions for CH1\_SYNC\_OFFSET

Bits	Bit Name	Settings	Description	Reset	Access
[7:0]	CH1_SYNC_OFFSET		Channel Sync Offset	0x0	R/W

**CHANNEL 2 SYNC OFFSET REGISTER**

Address: 0x00B, Reset: 0x00, Name: CH2\_SYNC\_OFFSET

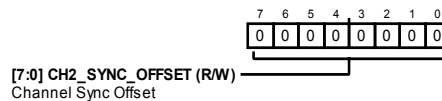

Table 56. Bit Descriptions for CH2\_SYNC\_OFFSET

Bits	Bit Name	Settings	Description	Reset	Access
[7:0]	CH2_SYNC_OFFSET		Channel Sync Offset	0x0	R/W

**CHANNEL 3 SYNC OFFSET REGISTER**

Address: 0x00C, Reset: 0x00, Name: CH3\_SYNC\_OFFSET

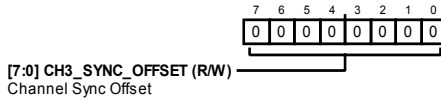

Table 57. Bit Descriptions for CH3\_SYNC\_OFFSET

Bits	Bit Name	Settings	Description	Reset	Access
[7:0]	CH3_SYNC_OFFSET		Channel Sync Offset	0x0	R/W

**CHANNEL 4 SYNC OFFSET REGISTER**

Address: 0x00D, Reset: 0x00, Name: CH4\_SYNC\_OFFSET

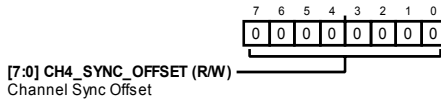

Table 58. Bit Descriptions for CH4\_SYNC\_OFFSET

Bits	Bit Name	Settings	Description	Reset	Access
[7:0]	CH4_SYNC_OFFSET		Channel Sync Offset	0x0	R/W

**CHANNEL 5 SYNC OFFSET REGISTER**

Address: 0x00E, Reset: 0x00, Name: CH5\_SYNC\_OFFSET

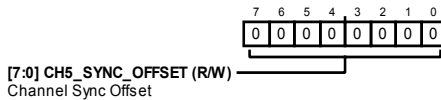

Table 59. Bit Descriptions for CH5\_SYNC\_OFFSET

Bits	Bit Name	Settings	Description	Reset	Access
[7:0]	CH5_SYNC_OFFSET		Channel Sync Offset	0x0	R/W

**CHANNEL 6 SYNC OFFSET REGISTER**

Address: 0x00F, Reset: 0x00, Name: CH6\_SYNC\_OFFSET

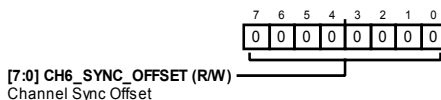

Table 60. Bit Descriptions for CH6\_SYNC\_OFFSET

Bits	Bit Name	Settings	Description	Reset	Access
[7:0]	CH6_SYNC_OFFSET		Channel Sync Offset	0x0	R/W

**CHANNEL 7 SYNC OFFSET REGISTER**

Address: 0x010, Reset: 0x00, Name: CH7\_SYNC\_OFFSET

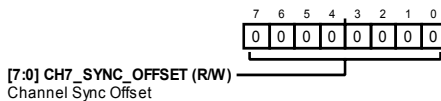

Table 61. Bit Descriptions for CH7\_SYNC\_OFFSET

Bits	Bit Name	Settings	Description	Reset	Access
[7:0]	CH7_SYNC_OFFSET		Channel Sync Offset	0x0	R/W

**GENERAL USER CONFIGURATION 1 REGISTER**

Address: 0x011, Reset: 0x24, Name: GENERAL\_USER\_CONFIG\_1

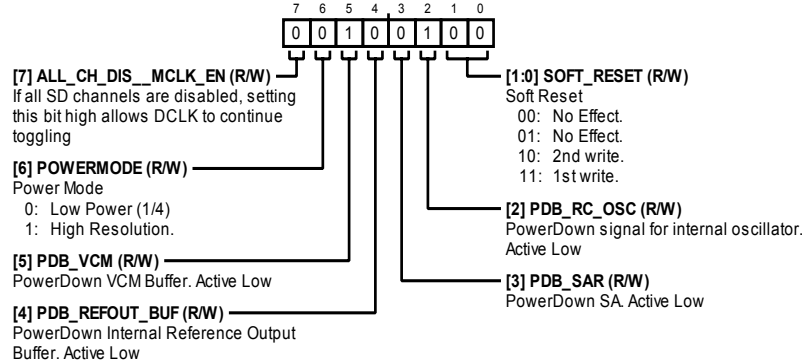

Table 62. Bit Descriptions for GENERAL\_USER\_CONFIG\_1

Bits	Bit Name	Settings	Description	Reset	Access
7	ALL_CH_DIS_MCLK_EN		If all $\Sigma$ - $\Delta$ channels are disabled, setting this bit high allows DCLK to continue toggling.	0x0	R/W
6	POWERMODE	0 1	Power Mode. Low power (1/4). High resolution.	0x0	R/W
5	PDB_VCM		Power Down VCM Buffer. Active low.	0x1	R/W
4	PDB_REFOUT_BUF		Power Down Internal Reference Output Buffer. Active low.	0x0	R/W
3	PDB_SAR		Power Down SAR. Active low.	0x0	R/W
2	PDB_RC_OSC		Power Down Signal for Internal Oscillator. Active low.	0x1	R/W
[1:0]	SOFT_RESET	00 01 10 11	Soft Reset. No effect. No effect. 2nd write. 1st write.	0x0	R/W

**GENERAL USER CONFIGURATION 2 REGISTER**

Address: 0x012, Reset: 0x09, Name: GENERAL\_USER\_CONFIG\_2

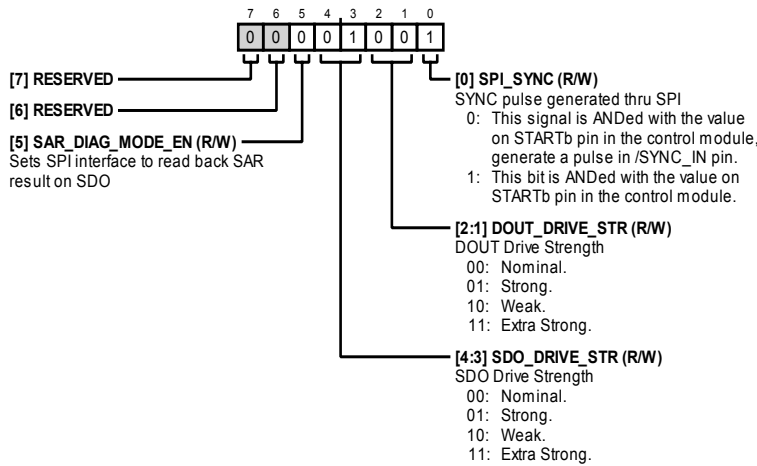

Table 63. Bit Descriptions for GENERAL\_USER\_CONFIG\_2

Bits	Bit Name	Settings	Description	Reset	Access
[7:6]	RESERVED		Reserved.	0x0	R/W
5	SAR_DIAG_MODE_EN		Sets SPI to Read Back SAR Result on SDO.	0x0	R/W

Bits	Bit Name	Settings	Description	Reset	Access
[4:3]	SDO_DRIVE_STR	00 01 10 11	SDO Drive Strength. Nominal. Strong. Weak. Extra strong.	0x1	R/W
[2:1]	DOUT_DRIVE_STR	00 01 10 11	DOUTx Drive Strength. Nominal. Strong. Weak. Extra strong.	0x0	R/W
0	SPI_SYNC	0 1	SYNC Pulse Generated Through SPI. This signal is AND'ed with the value on the $\overline{\text{START}}$ pin in the control module and generates a pulse in the $\overline{\text{SYNC\_IN}}$ pin. This bit is AND'ed with the value on $\overline{\text{START}}$ pin in the control module.	0x1	R/W

**GENERAL USER CONFIGURATION 3 REGISTER**

Address: 0x013, Reset: 0x80, Name: GENERAL\_USER\_CONFIG\_3

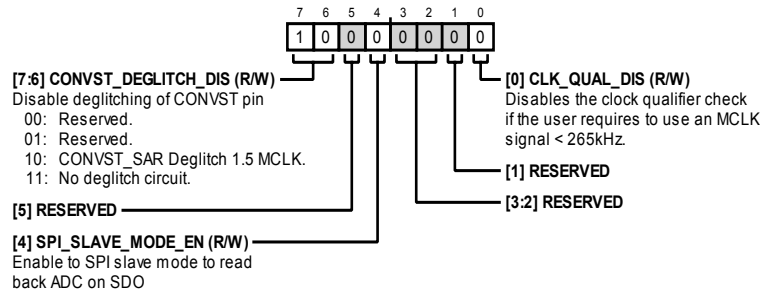

Table 64. Bit Descriptions for GENERAL\_USER\_CONFIG\_3

Bits	Bit Name	Settings	Description	Reset	Access
[7:6]	CONVST_DEGLITCH_DIS	00 01 10 11	Disable deglitching of CONVST_SAR pin. Reserved. Reserved. CONVST_SAR deglitch 1.5/MCLK. No deglitch circuit.	0x2	R/W
5	RESERVED		Reserved.	0x0	R/W
4	SPI_SLAVE_MODE_EN		Enable to SPI slave mode to read back ADC on SDO.	0x0	R/W
[3:2]	RESERVED		Reserved.	0x0	R/W
1	RESERVED		Reserved.	0x0	R/W
0	CLK_QUAL_DIS		Disables the clock qualifier check if the user requires to use an MCLK signal <265 kHz.	0x0	R/W



**DATA OUTPUT FORMAT REGISTER**

Address: 0x014, Reset: 0x20, Name: DOUT\_FORMAT

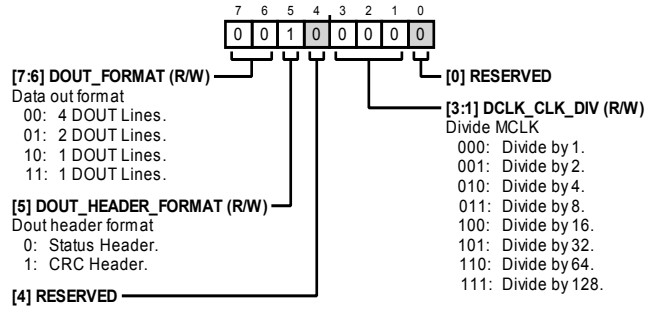

Table 65. Bit Descriptions for DOUT\_FORMAT

Bits	Bit Name	Settings	Description	Reset	Access
[7:6]	DOUT_FORMAT	00 01 10 11	Data Out Format 4 DOUTx lines 2 DOUTx lines 1 DOUTx lines 1 DOUTx lines	0x0	R/W
5	DOUT_HEADER_FORMAT	0 1	DOUTx Header Format Status header CRC header	0x1	R/W
4	RESERVED		Reserved	0x0	R/W
[3:1]	DCLK_CLK_DIV	000 001 010 011 100 101 110 111	Divide MCLK Divide by 1 Divide by 2 Divide by 4 Divide by 8 Divide by 16 Divide by 32 Divide by 64 Divide by 128	0x0	R/W
0	RESERVED		Reserved	0x0	R/W

**MAIN ADC METER AND REFERENCE MUX CONTROL REGISTER**

Address: 0x015, Reset: 0x00, Name: ADC\_MUX\_CONFIG

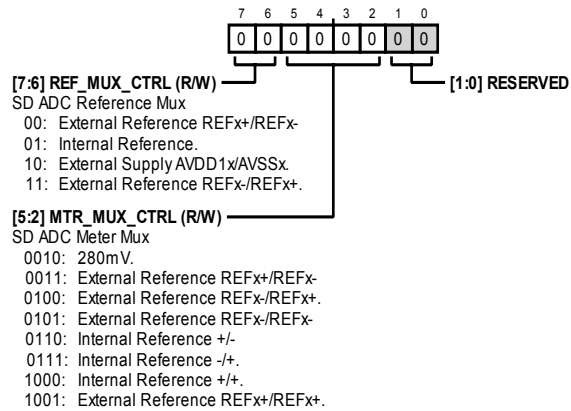

Table 66. Bit Descriptions for ADC\_MUX\_CONFIG

Bits	Bit Name	Settings	Description	Reset	Access
[7:6]	REF_MUX_CTRL	00 01 10 11	$\Sigma$ - $\Delta$ ADC Reference Mux External reference REFx+/REFx- Internal reference. External supply AVDD1x/AVSSx External reference REFx-/REFx+	0x0	R/W
[5:2]	MTR_MUX_CTRL	0010 0011 0100 0101 0110 0111 1000 1001	$\Sigma$ - $\Delta$ ADC Meter Mux 280 mV External reference REFx+/REFx- External reference REFx-/REFx+ External reference REFx-/REFx- Internal reference +/- Internal reference -/+ Internal reference +/+ External reference REFx+/REFx+	0x0	R/W
[1:0]	RESERVED		Reserved	0x0	R/W

**GLOBAL DIAGNOSTICS MUX REGISTER**

Address: 0x016, Reset: 0x00, Name: GLOBAL\_MUX\_CONFIG

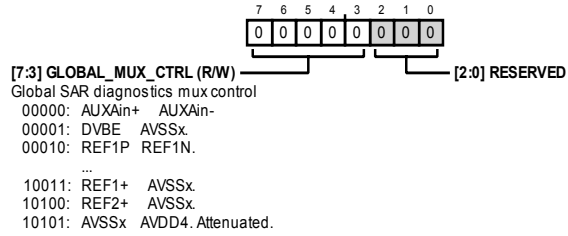

Table 67. Bit Descriptions for GLOBAL\_MUX\_CONFIG

Bits	Bit Name	Settings	Description	Reset	Access
[7:3]	GLOBAL_MUX_CTRL		Global SAR Diagnostics Mux Control.	0x0	R/W
		00000	AUXAIN+/AUXAIN-.		
		00001	DV <sub>BE</sub> /AVSSx.		
		00010	REF1+/REF1-.		
		00011	REF2+/REF2-.		
		00100	REF_OUT/AVSSx.		
		00101	VCN/AVSSx.		
		00110	AREG1CAP/AVSSx.		
		00111	AREG2CAP/AVSSx.		
		01000	DREGCAP/DGND.		
		01001	AVDD1A/AVSSx.		
		01010	AVDD1B/AVSSx.		
		01011	AVDD2A/AVSSx.		
		01100	AVDD2B/AVSSx.		
		01101	IOVDD/DGND.		
		01110	AVDD4/AVSSx.		
		01111	DGND/AVSSx.		
		10000	DGND/AVSSx.		
		10001	DGND/AVSSx.		
		10010	AVDD4/AVSSx.		
		10011	REF1+/AVSSx.		
		10100	REF2+/AVSSx.		
		10101	AVSSx/AVDD4. Attenuated.		
[2:0]	RESERVED		Reserved.	0x0	R/W

**GPIO CONFIGURATION REGISTER**

Address: 0x017, Reset: 0x00, Name: GPIO\_CONFIG

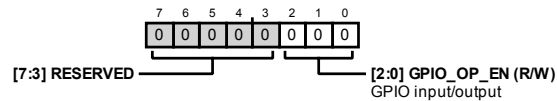

Table 68. Bit Descriptions for GPIO\_CONFIG

Bits	Bit Name	Settings	Description	Reset	Access
[7:3]	RESERVED		Reserved	0x0	R/W
[2:0]	GPIO_OP_EN		GPIO Input/Output	0x0	R/W

### GPIO DATA REGISTER

Address: 0x018, Reset: 0x00, Name: GPIO\_DATA

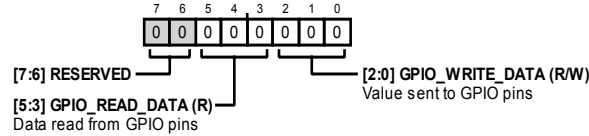

Table 69. Bit Descriptions for GPIO\_DATA

Bits	Bit Name	Settings	Description	Reset	Access
[7:6]	RESERVED		Reserved	0x0	R/W
[5:3]	GPIO_READ_DATA		Data Read from the GPIO Pins	0x0	R
[2:0]	GPIO_WRITE_DATA		Value Sent to the GPIO Pins	0x0	R/W

### BUFFER CONFIGURATION 1 REGISTER

Address: 0x019, Reset: 0x38, Name: BUFFER\_CONFIG\_1

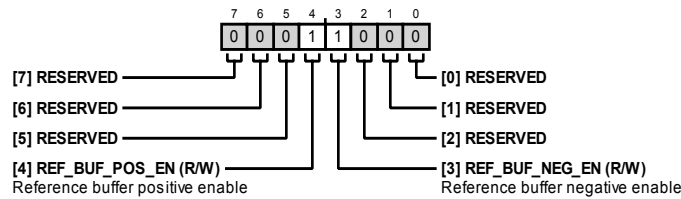

Table 70. Bit Descriptions for BUFFER\_CONFIG\_1

Bits	Bit Name	Settings	Description	Reset	Access
[7:5]	RESERVED		Reserved	0x0	R/W
4	REF_BUF_POS_EN		Reference Buffer Positive Enable	0x1	R/W
3	REF_BUF_NEG_EN		Reference Buffer Negative Enable	0x1	R/W
[2:0]	RESERVED		Reserved	0x0	R/W

### BUFFER CONFIGURATION 2 REGISTER

Address: 0x01A, Reset: 0xC0, Name: BUFFER\_CONFIG\_2

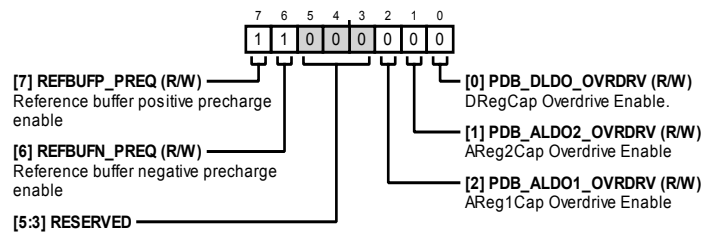

Table 71. Bit Descriptions for BUFFER\_CONFIG\_2

Bits	Bit Name	Settings	Description	Reset	Access
7	REFBUF*_PREQ		Reference Buffer Positive Precharge Enable	0x1	R/W
6	REFBUF*_PREQ		Reference Buffer Negative Precharge Enable	0x1	R/W
[5:3]	RESERVED		Reserved	0x0	R/W
2	PDB_ALDO1_OVRDRV		AReg1CAP Overdrive Enable	0x0	R/W
1	PDB_ALDO2_OVRDRV		AReg2CAP Overdrive Enable	0x0	R/W
0	PDB_DLDO_OVRDRV		DREGCAP Overdrive Enable	0x0	R/W

**CHANNEL 0 OFFSET UPPER BYTE REGISTER**

Address: 0x01C, Reset: 0x00, Name: CH0\_OFFSET\_UPPER\_BYTE

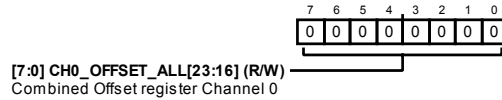

Table 72. Bit Descriptions for CH0\_OFFSET\_UPPER\_BYTE

Bits	Bit Name	Settings	Description	Reset	Access
[7:0]	CH0_OFFSET_ALL[23:16]		Combined Offset Register Channel 0	0x0	R/W

**CHANNEL 0 OFFSET MIDDLE BYTE REGISTER**

Address: 0x01D, Reset: 0x00, Name: CH0\_OFFSET\_MID\_BYTE

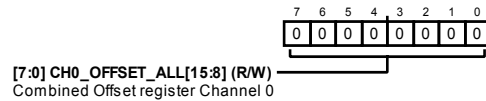

Table 73. Bit Descriptions for CH0\_OFFSET\_MID\_BYTE

Bits	Bit Name	Settings	Description	Reset	Access
[7:0]	CH0_OFFSET_ALL[15:8]		Combined Offset Register Channel 0	0x0	R/W

**CHANNEL 0 OFFSET LOWER BYTE REGISTER**

Address: 0x01E, Reset: 0x00, Name: CH0\_OFFSET\_LOWER\_BYTE

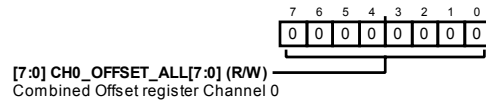

Table 74. Bit Descriptions for CH0\_OFFSET\_LOWER\_BYTE

Bits	Bit Name	Settings	Description	Reset	Access
[7:0]	CH0_OFFSET_ALL[7:0]		Combined Offset Register Channel 0	0x0	R/W

**CHANNEL 0 GAIN UPPER BYTE REGISTER**

Address: 0x01F, Reset: 0x00, Name: CH0\_GAIN\_UPPER\_BYTE

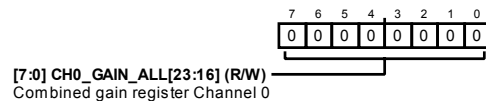

Table 75. Bit Descriptions for CH0\_GAIN\_UPPER\_BYTE

Bits	Bit Name	Settings	Description	Reset	Access
[7:0]	CH0_GAIN_ALL[23:16]		Combined Gain Register Channel 0	0x0	R/W

**CHANNEL 0 GAIN MIDDLE BYTE REGISTER**

Address: 0x020, Reset: 0x00, Name: CH0\_GAIN\_MID\_BYTE

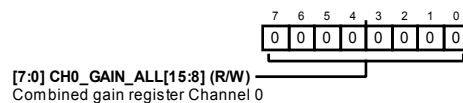
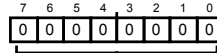

Table 76. Bit Descriptions for CH0\_GAIN\_MID\_BYTE

Bits	Bit Name	Settings	Description	Reset	Access
[7:0]	CH0_GAIN_ALL[15:8]		Combined Gain Register Channel 0	0x0	R/W

### CHANNEL 0 GAIN LOWER BYTE REGISTER

Address: 0x021, Reset: 0x00, Name: CH0\_GAIN\_LOWER\_BYTE



[7:0] CH0\_GAIN\_ALL[7:0] (R/W)  
Combined gain register Channel 0

Table 77. Bit Descriptions for CH0\_GAIN\_LOWER\_BYTE

Bits	Bit Name	Settings	Description	Reset	Access
[7:0]	CH0_GAIN_ALL[7:0]		Combined Gain Register Channel 0	0x0	R/W

### CHANNEL 1 OFFSET UPPER BYTE REGISTER

Address: 0x022, Reset: 0x00, Name: CH1\_OFFSET\_UPPER\_BYTE

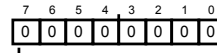

[7:0] CH1\_OFFSET\_ALL[23:16] (R/W)  
Combined offset register Channel 1

Table 78. Bit Descriptions for CH1\_OFFSET\_UPPER\_BYTE

Bits	Bit Name	Settings	Description	Reset	Access
[7:0]	CH1_OFFSET_ALL[23:16]		Combined Offset Register Channel 1	0x0	R/W

### CHANNEL 1 OFFSET MIDDLE BYTE REGISTER

Address: 0x023, Reset: 0x00, Name: CH1\_OFFSET\_MID\_BYTE

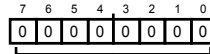

[7:0] CH1\_OFFSET\_ALL[15:8] (R/W)  
Combined offset register Channel 1

Table 79. Bit Descriptions for CH1\_OFFSET\_MID\_BYTE

Bits	Bit Name	Settings	Description	Reset	Access
[7:0]	CH1_OFFSET_ALL[15:8]		Combined Offset Register Channel 1	0x0	R/W

### CHANNEL 1 OFFSET LOWER BYTE REGISTER

Address: 0x024, Reset: 0x00, Name: CH1\_OFFSET\_LOWER\_BYTE

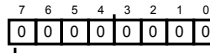

[7:0] CH1\_OFFSET\_ALL[7:0] (R/W)  
Combined offset register Channel 1

Table 80. Bit Descriptions for CH1\_OFFSET\_LOWER\_BYTE

Bits	Bit Name	Settings	Description	Reset	Access
[7:0]	CH1_OFFSET_ALL[7:0]		Combined Offset Register Channel 1	0x0	R/W

**CHANNEL 1 GAIN UPPER BYTE REGISTER**

Address: 0x025, Reset: 0x00, Name: CH1\_GAIN\_UPPER\_BYTE

[7:0] CH1\_GAIN\_ALL[23:16] (R/W)  
Combined gain register Channel 1

Table 81. Bit Descriptions for CH1\_GAIN\_UPPER\_BYTE

Bits	Bit Name	Settings	Description	Reset	Access
[7:0]	CH1_GAIN_ALL[23:16]		Combined Gain Register Channel 1	0x0	R/W

**CHANNEL 1 GAIN MIDDLE BYTE REGISTER**

Address: 0x026, Reset: 0x00, Name: CH1\_GAIN\_MID\_BYTE

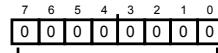
[7:0] CH1\_GAIN\_ALL[15:8] (R/W)  
Combined gain register Channel 1

Table 82. Bit Descriptions for CH1\_GAIN\_MID\_BYTE

Bits	Bit Name	Settings	Description	Reset	Access
[7:0]	CH1_GAIN_ALL[15:8]		Combined Gain Register Channel 1	0x0	R/W

**CHANNEL 1 GAIN LOWER BYTE REGISTER**

Address: 0x027, Reset: 0x00, Name: CH1\_GAIN\_LOWER\_BYTE

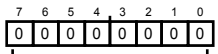
[7:0] CH1\_GAIN\_ALL[7:0] (R/W)  
Combined gain register Channel 1

Table 83. Bit Descriptions for CH1\_GAIN\_LOWER\_BYTE

Bits	Bit Name	Settings	Description	Reset	Access
[7:0]	CH1_GAIN_ALL[7:0]		Combined Gain Register Channel 1	0x0	R/W

**CHANNEL 2 OFFSET UPPER BYTE REGISTER**

Address: 0x028, Reset: 0x00, Name: CH2\_OFFSET\_UPPER\_BYTE

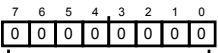
[7:0] CH2\_OFFSET\_ALL[23:16] (R/W)  
Combined offset register Channel 2

Table 84. Bit Descriptions for CH2\_OFFSET\_UPPER\_BYTE

Bits	Bit Name	Settings	Description	Reset	Access
[7:0]	CH2_OFFSET_ALL[23:16]		Combined Offset Register Channel 2	0x0	R/W

**CHANNEL 2 OFFSET MIDDLE BYTE REGISTER**

Address: 0x029, Reset: 0x00, Name: CH2\_OFFSET\_MID\_BYTE

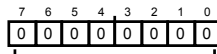
[7:0] CH2\_OFFSET\_ALL[15:8] (R/W)  
Combined offset register Channel 2

Table 85. Bit Descriptions for CH2\_OFFSET\_MID\_BYTE

Bits	Bit Name	Settings	Description	Reset	Access
[7:0]	CH2_OFFSET_ALL[15:8]		Combined Offset Register Channel 2	0x0	R/W

**CHANNEL 2 OFFSET LOWER BYTE REGISTER**

Address: 0x02A, Reset: 0x00, Name: CH2\_OFFSET\_LOWER\_BYTE

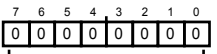
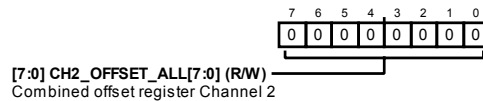

Table 86. Bit Descriptions for CH2\_OFFSET\_LOWER\_BYTE

Bits	Bit Name	Settings	Description	Reset	Access
[7:0]	CH2_OFFSET_ALL[7:0]		Combined Offset Register Channel 2	0x0	R/W

**CHANNEL 2 GAIN UPPER BYTE REGISTER**

Address: 0x02B, Reset: 0x00, Name: CH2\_GAIN\_UPPER\_BYTE

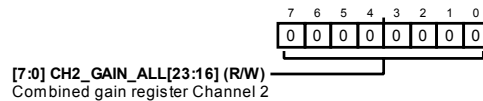

Table 87. Bit Descriptions for CH2\_GAIN\_UPPER\_BYTE

Bits	Bit Name	Settings	Description	Reset	Access
[7:0]	CH2_GAIN_ALL[23:16]		Combined Gain Register Channel 2	0x0	R/W

**CHANNEL 2 GAIN MIDDLE BYTE REGISTER**

Address: 0x02C, Reset: 0x00, Name: CH2\_GAIN\_MID\_BYTE

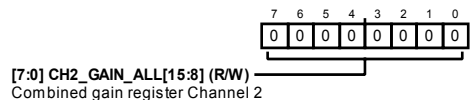

Table 88. Bit Descriptions for CH2\_GAIN\_MID\_BYTE

Bits	Bit Name	Settings	Description	Reset	Access
[7:0]	CH2_GAIN_ALL[15:8]		Combined Gain Register Channel 2	0x0	R/W

**CHANNEL 2 GAIN LOWER BYTE REGISTER**

Address: 0x02D, Reset: 0x00, Name: CH2\_GAIN\_LOWER\_BYTE

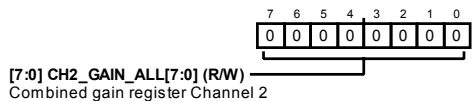

Table 89. Bit Descriptions for CH2\_GAIN\_LOWER\_BYTE

Bits	Bit Name	Settings	Description	Reset	Access
[7:0]	CH2_GAIN_ALL[7:0]		Combined Gain Register Channel 2	0x0	R/W

**CHANNEL 3 OFFSET UPPER BYTE REGISTER**

Address: 0x02E, Reset: 0x00, Name: CH3\_OFFSET\_UPPER\_BYTE

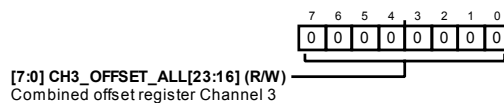

Table 90. Bit descriptions for CH3\_OFFSET\_UPPER\_BYTE

Bits	Bit Name	Settings	Description	Reset	Access
[7:0]	CH3_OFFSET_ALL[23:16]		Combined Offset Register Channel 3	0x0	R/W



**CHANNEL 3 OFFSET MIDDLE BYTE REGISTER**

Address: 0x02F, Reset: 0x00, Name: CH3\_OFFSET\_MID\_BYTE

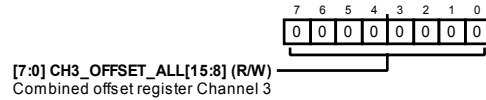

Table 91. Bit Descriptions for CH3\_OFFSET\_MID\_BYTE

Bits	Bit Name	Settings	Description	Reset	Access
[7:0]	CH3_OFFSET_ALL[15:8]		Combined Offset Register Channel 3	0x0	R/W

**CHANNEL 3 OFFSET LOWER BYTE REGISTER**

Address: 0x030, Reset: 0x00, Name: CH3\_OFFSET\_LOWER\_BYTE

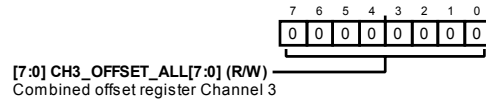

Table 92. Bit Descriptions for CH3\_OFFSET\_LOWER\_BYTE

Bits	Bit Name	Settings	Description	Reset	Access
[7:0]	CH3_OFFSET_ALL[7:0]		Combined Offset Register Channel 3	0x0	R/W

**CHANNEL 3 GAIN UPPER BYTE REGISTER**

Address: 0x031, Reset: 0x00, Name: CH3\_GAIN\_UPPER\_BYTE

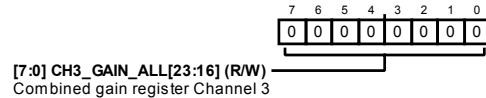

Table 93. Bit Descriptions for CH3\_GAIN\_UPPER\_BYTE

Bits	Bit Name	Settings	Description	Reset	Access
[7:0]	CH3_GAIN_ALL[23:16]		Combined Gain Register Channel 3	0x0	R/W

**CHANNEL 3 GAIN MIDDLE BYTE REGISTER**

Address: 0x032, Reset: 0x00, Name: CH3\_GAIN\_MID\_BYTE

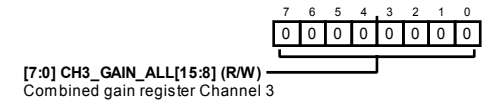

Table 94. Bit Descriptions for CH3\_GAIN\_MID\_BYTE

Bits	Bit Name	Settings	Description	Reset	Access
[7:0]	CH3_GAIN_ALL[15:8]		Combined Gain Register Channel 3	0x0	R/W

**CHANNEL 3 GAIN LOWER BYTE REGISTER**

Address: 0x033, Reset: 0x00, Name: CH3\_GAIN\_LOWER\_BYTE

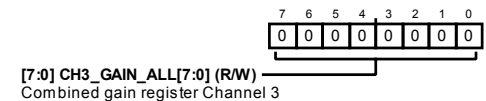

Table 95. Bit Descriptions for CH3\_GAIN\_LOWER\_BYTE

Bits	Bit Name	Settings	Description	Reset	Access
[7:0]	CH3_GAIN_ALL[7:0]		Combined Gain Register Channel 3	0x0	R/W

### CHANNEL 4 OFFSET UPPER BYTE REGISTER

Address: 0x034, Reset: 0x00, Name: CH4\_OFFSET\_UPPER\_BYTE

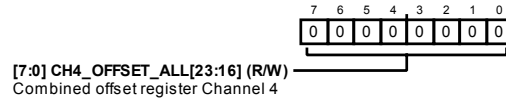

Table 96. Bit Descriptions for CH4\_OFFSET\_UPPER\_BYTE

Bits	Bit Name	Settings	Description	Reset	Access
[7:0]	CH4_OFFSET_ALL[23:16]		Combined Offset Register Channel 4	0x0	R/W

### CHANNEL 4 OFFSET MIDDLE BYTE REGISTER

Address: 0x035, Reset: 0x00, Name: CH4\_OFFSET\_MID\_BYTE

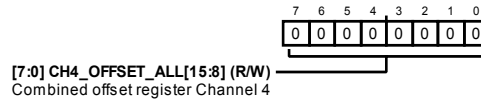

Table 97. Bit Descriptions for CH4\_OFFSET\_MID\_BYTE

Bits	Bit Name	Settings	Description	Reset	Access
[7:0]	CH4_OFFSET_ALL[15:8]		Combined Offset Register Channel 4	0x0	R/W

### CHANNEL 4 OFFSET LOWER BYTE REGISTER

Address: 0x036, Reset: 0x00, Name: CH4\_OFFSET\_LOWER\_BYTE

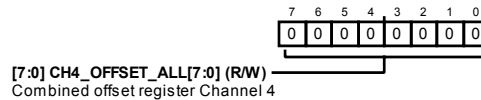

Table 98. Bit Descriptions for CH4\_OFFSET\_LOWER\_BYTE

Bits	Bit Name	Settings	Description	Reset	Access
[7:0]	CH4_OFFSET_ALL[7:0]		Combined Offset Register Channel 4	0x0	R/W

### CHANNEL 4 GAIN UPPER BYTE REGISTER

Address: 0x037, Reset: 0x00, Name: CH4\_GAIN\_UPPER\_BYTE

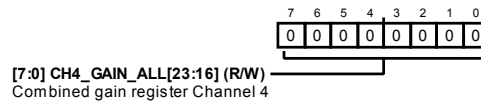

Table 99. Bit Descriptions for CH4\_GAIN\_UPPER\_BYTE

Bits	Bit Name	Settings	Description	Reset	Access
[7:0]	CH4_GAIN_ALL[23:16]		Combined Gain Register Channel 4	0x0	R/W

### CHANNEL 4 GAIN MIDDLE BYTE REGISTER

Address: 0x038, Reset: 0x00, Name: CH4\_GAIN\_MID\_BYTE

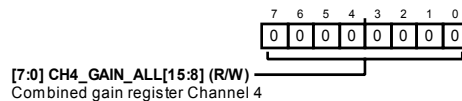

Table 100. Bit Descriptions for CH4\_GAIN\_MID\_BYTE

Bits	Bit Name	Settings	Description	Reset	Access
[7:0]	CH4_GAIN_ALL[15:8]		Combined Gain Register Channel 4	0x0	R/W

**CHANNEL 4 GAIN LOWER BYTE REGISTER**

Address: 0x039, Reset: 0x00, Name: CH4\_GAIN\_LOWER\_BYTE

[7:0] CH4\_GAIN\_ALL[7:0] (R/W)  
Combined gain register Channel 4

Table 101. Bit Descriptions for CH4\_GAIN\_LOWER\_BYTE

Bits	Bit Name	Settings	Description	Reset	Access
[7:0]	CH4_GAIN_ALL[7:0]		Combined Gain Register Channel 4	0x0	R/W

**CHANNEL 5 OFFSET UPPER BYTE REGISTER**

Address: 0x03A, Reset: 0x00, Name: CH5\_OFFSET\_UPPER\_BYTE

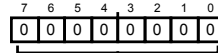
[7:0] CH5\_OFFSET\_ALL[23:16] (R/W)  
Combined offset register Channel 5

Table 102. Bit Descriptions for CH5\_OFFSET\_UPPER\_BYTE

Bits	Bit Name	Settings	Description	Reset	Access
[7:0]	CH5_OFFSET_ALL[23:16]		Combined Offset Register Channel 5	0x0	R/W

**CHANNEL 5 OFFSET MIDDLE BYTE REGISTER**

Address: 0x03B, Reset: 0x00, Name: CH5\_OFFSET\_MID\_BYTE

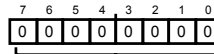
[7:0] CH5\_OFFSET\_ALL[15:8] (R/W)  
Combined offset register Channel 5

Table 103. Bit Descriptions for CH5\_OFFSET\_MID\_BYTE

Bits	Bit Name	Settings	Description	Reset	Access
[7:0]	CH5_OFFSET_ALL[15:8]		Combined Offset Register Channel 5	0x0	R/W

**CHANNEL 5 OFFSET LOWER BYTE REGISTER**

Address: 0x03C, Reset: 0x00, Name: CH5\_OFFSET\_LOWER\_BYTE

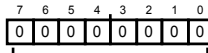
[7:0] CH5\_OFFSET\_ALL[7:0] (R/W)  
Combined offset register Channel 5

Table 104. Bit Descriptions for CH5\_OFFSET\_LOWER\_BYTE

Bits	Bit Name	Settings	Description	Reset	Access
[7:0]	CH5_OFFSET_ALL[7:0]		Combined Offset Register Channel 5	0x0	R/W

**CHANNEL 5 GAIN UPPER BYTE REGISTER**

Address: 0x03D, Reset: 0x00, Name: CH5\_GAIN\_UPPER\_BYTE

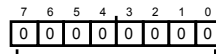
[7:0] CH5\_GAIN\_ALL[23:16] (R/W)  
Combined gain register Channel 5

Table 105. Bit Descriptions for CH5\_GAIN\_UPPER\_BYTE

Bits	Bit Name	Settings	Description	Reset	Access
[7:0]	CH5_GAIN_ALL[23:16]		Combined Gain Register Channel 5	0x0	R/W

### CHANNEL 5 GAIN MIDDLE BYTE REGISTER

Address: 0x03E, Reset: 0x00, Name: CH5\_GAIN\_MID\_BYTE

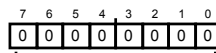
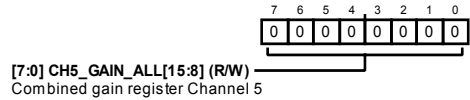

Table 106. Bit Descriptions for CH5\_GAIN\_MID\_BYTE

Bits	Bit Name	Settings	Description	Reset	Access
[7:0]	CH5_GAIN_ALL[15:8]		Combined Gain Register Channel 5	0x0	R/W

### CHANNEL 5 GAIN LOWER BYTE REGISTER

Address: 0x03F, Reset: 0x00, Name: CH5\_GAIN\_LOWER\_BYTE

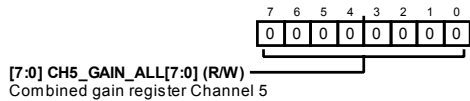

Table 107. Bit Descriptions for CH5\_GAIN\_LOWER\_BYTE

Bits	Bit Name	Settings	Description	Reset	Access
[7:0]	CH5_GAIN_ALL[7:0]		Combined Gain Register Channel 5	0x0	R/W

### CHANNEL 6 OFFSET UPPER BYTE REGISTER

Address: 0x040, Reset: 0x00, Name: CH6\_OFFSET\_UPPER\_BYTE

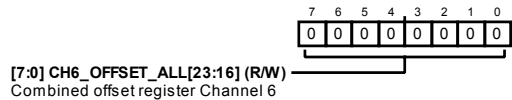

Table 108. Bit Descriptions for CH6\_OFFSET\_UPPER\_BYTE

Bits	Bit Name	Settings	Description	Reset	Access
[7:0]	CH6_OFFSET_ALL[23:16]		Combined Offset Register Channel 6	0x0	R/W

### CHANNEL 6 OFFSET MIDDLE BYTE REGISTER

Address: 0x041, Reset: 0x00, Name: CH6\_OFFSET\_MID\_BYTE

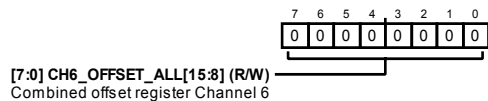

Table 109. Bit Descriptions for CH6\_OFFSET\_MID\_BYTE

Bits	Bit Name	Settings	Description	Reset	Access
[7:0]	CH6_OFFSET_ALL[15:8]		Combined Offset Register Channel 6	0x0	R/W

### CHANNEL 6 OFFSET LOWER BYTE REGISTER

Address: 0x042, Reset: 0x00, Name: CH6\_OFFSET\_LOWER\_BYTE

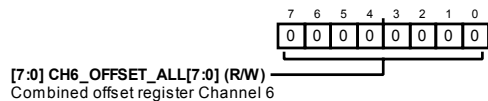

Table 110. Bit Descriptions for CH6\_OFFSET\_LOWER\_BYTE

Bits	Bit Name	Settings	Description	Reset	Access
[7:0]	CH6_OFFSET_ALL[7:0]		Combined Offset Register Channel 6	0x0	R/W

**CHANNEL 6 GAIN UPPER BYTE REGISTER**

Address: 0x043, Reset: 0x00, Name: CH6\_GAIN\_UPPER\_BYTE

[7:0] CH6\_GAIN\_ALL[23:16] (R/W)  
Combined gain register Channel 6

Table 111. Bit Descriptions for CH6\_GAIN\_UPPER\_BYTE

Bits	Bit Name	Settings	Description	Reset	Access
[7:0]	CH6_GAIN_ALL[23:16]		Combined Gain Register Channel 6	0x0	R/W

**CHANNEL 6 GAIN MIDDLE BYTE REGISTER**

Address: 0x044, Reset: 0x00, Name: CH6\_GAIN\_MID\_BYTE

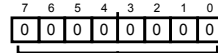
[7:0] CH6\_GAIN\_ALL[15:8] (R/W)  
Combined gain register Channel 6

Table 112. Bit Descriptions for CH6\_GAIN\_MID\_BYTE

Bits	Bit Name	Settings	Description	Reset	Access
[7:0]	CH6_GAIN_ALL[15:8]		Combined Gain Register Channel 6	0x0	R/W

**CHANNEL 6 GAIN LOWER BYTE REGISTER**

Address: 0x045, Reset: 0x00, Name: CH6\_GAIN\_LOWER\_BYTE

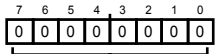
[7:0] CH6\_GAIN\_ALL[7:0] (R/W)  
Combined gain register Channel 6

Table 113. Bit Descriptions for CH6\_GAIN\_LOWER\_BYTE

Bits	Bit Name	Settings	Description	Reset	Access
[7:0]	CH6_GAIN_ALL[7:0]		Combined Gain Register Channel 6	0x0	R/W

**CHANNEL 7 OFFSET UPPER BYTE REGISTER**

Address: 0x046, Reset: 0x00, Name: CH7\_OFFSET\_UPPER\_BYTE

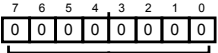
[7:0] CH7\_OFFSET\_ALL[23:16] (R/W)  
Combined offset register Channel 7

Table 114. Bit Descriptions for CH7\_OFFSET\_UPPER\_BYTE

Bits	Bit Name	Settings	Description	Reset	Access
[7:0]	CH7_OFFSET_ALL[23:16]		Combined Offset Register Channel 7	0x0	R/W

**CHANNEL 7 OFFSET MIDDLE BYTE REGISTER**

Address: 0x047, Reset: 0x00, Name: CH7\_OFFSET\_MID\_BYTE

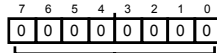
[7:0] CH7\_OFFSET\_ALL[15:8] (R/W)  
Combined offset register Channel 7

Table 115. Bit Descriptions for CH7\_OFFSET\_MID\_BYTE

Bits	Bit Name	Settings	Description	Reset	Access
[7:0]	CH7_OFFSET_ALL[15:8]		Combined Offset Register Channel 7	0x0	R/W

**CHANNEL 7 OFFSET LOWER BYTE REGISTER**

Address: 0x048, Reset: 0x00, Name: CH7\_OFFSET\_LOWER\_BYTE

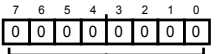
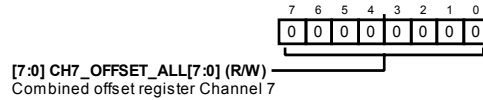

Table 116. Bit Descriptions for CH7\_OFFSET\_LOWER\_BYTE

Bits	Bit Name	Settings	Description	Reset	Access
[7:0]	CH7_OFFSET_ALL[7:0]		Combined Offset Register Channel 7	0x0	R/W

**CHANNEL 7 GAIN UPPER BYTE REGISTER**

Address: 0x049, Reset: 0x00, Name: CH7\_GAIN\_UPPER\_BYTE

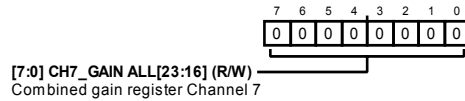

Table 117. Bit Descriptions for CH7\_GAIN\_UPPER\_BYTE

Bits	Bit Name	Settings	Description	Reset	Access
[7:0]	CH7_GAIN_ALL[23:16]		Combined Gain Register Channel 7	0x0	R/W

**CHANNEL 7 GAIN MIDDLE BYTE REGISTER**

Address: 0x04A, Reset: 0x00, Name: CH7\_GAIN\_MID\_BYTE

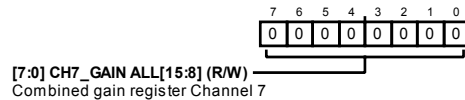

Table 118. Bit Descriptions for CH7\_GAIN\_MID\_BYTE

Bits	Bit Name	Settings	Description	Reset	Access
[7:0]	CH7_GAIN_ALL[15:8]		Combined Gain Register Channel 7	0x0	R/W

**CHANNEL 7 GAIN LOWER BYTE REGISTER**

Address: 0x04B, Reset: 0x00, Name: CH7\_GAIN\_LOWER\_BYTE

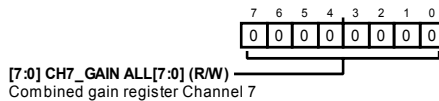

Table 119. Bit Descriptions for CH7\_GAIN\_LOWER\_BYTE

Bits	Bit Name	Settings	Description	Reset	Access
[7:0]	CH7_GAIN_ALL[7:0]		Combined Gain Register Channel 7	0x0	R/W

**CHANNEL 0 STATUS REGISTER**

Address: 0x04C, Reset: 0x00, Name: CH0\_ERR\_REG

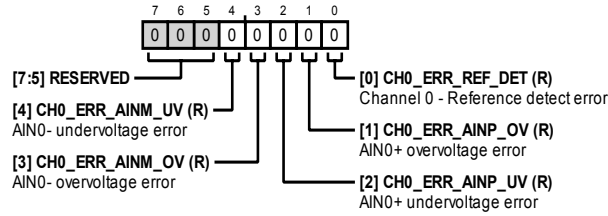

Table 120. Bit Descriptions for CH0\_ERR\_REG

Bits	Bit Name	Settings	Description	Reset	Access
[7:5]	RESERVED		Reserved	0x0	R/W
4	CH0_ERR_AINM_UV		Channel 0—AIN0– Undervoltage Error	0x0	R
3	CH0_ERR_AINM_OV		Channel 0—AIN0– Overvoltage Error	0x0	R
2	CH0_ERR_AINP_UV		Channel 0—AIN0+ Undervoltage Error	0x0	R
1	CH0_ERR_AINP_OV		Channel 0—AIN0+ Overvoltage Error	0x0	R
0	CH0_ERR_REF_DET		Channel 0—Reference Detect Error	0x0	R

**CHANNEL 1 STATUS REGISTER**

Address: 0x04D, Reset: 0x00, Name: CH1\_ERR\_REG

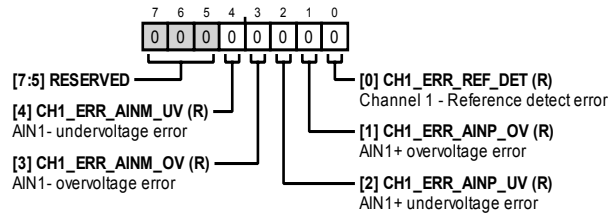

Table 121. Bit Descriptions for CH1\_ERR\_REG

Bits	Bit Name	Settings	Description	Reset	Access
[7:5]	RESERVED		Reserved	0x0	R/W
4	CH1_ERR_AINM_UV		Channel 1—AIN1– Undervoltage Error	0x0	R
3	CH1_ERR_AINM_OV		Channel 1—AIN1– Overvoltage Error	0x0	R
2	CH1_ERR_AINP_UV		Channel 1—AIN1+ Undervoltage Error	0x0	R
1	CH1_ERR_AINP_OV		Channel 1—AIN1+ Overvoltage Error	0x0	R
0	CH1_ERR_REF_DET		Channel 1—Reference Detect Error	0x0	R

### CHANNEL 2 STATUS REGISTER

Address: 0x04E, Reset: 0x00, Name: CH2\_ERR\_REG

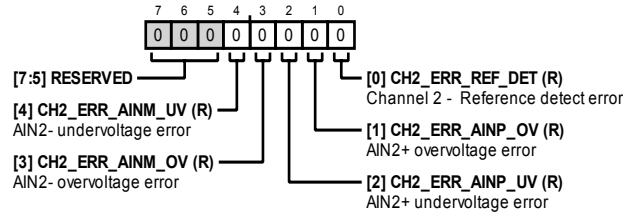

Table 122. Bit Descriptions for CH2\_ERR\_REG

Bits	Bit Name	Settings	Description	Reset	Access
[7:5]	RESERVED		Reserved	0x0	R/W
4	CH2_ERR_AINM_UV		Channel 2—AIN2– Undervoltage Error	0x0	R
3	CH2_ERR_AINM_OV		Channel 2—AIN2– Overvoltage Error	0x0	R
2	CH2_ERR_AINP_UV		Channel 2—AIN2+ Undervoltage Error	0x0	R
1	CH2_ERR_AINP_OV		Channel 2—AIN2+ Overvoltage Error	0x0	R
0	CH2_ERR_REF_DET		Channel 2—Reference Detect Error	0x0	R

### CHANNEL 3 STATUS REGISTER

Address: 0x04F, Reset: 0x00, Name: CH3\_ERR\_REG

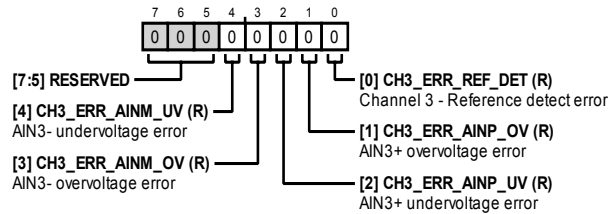

Table 123. Bit Descriptions for CH3\_ERR\_REG

Bits	Bit Name	Settings	Description	Reset	Access
[7:5]	RESERVED		Reserved	0x0	R/W
4	CH3_ERR_AINM_UV		Channel 3—AIN3– Undervoltage Error	0x0	R
3	CH3_ERR_AINM_OV		Channel 3—AIN3– Overvoltage Error	0x0	R
2	CH3_ERR_AINP_UV		Channel 3—AIN3+ Undervoltage Error	0x0	R
1	CH3_ERR_AINP_OV		Channel 3—AIN3+ Overvoltage Error	0x0	R
0	CH3_ERR_REF_DET		Channel 3—Reference Detect Error	0x0	R



**CHANNEL 4 STATUS REGISTER**

Address: 0x050, Reset: 0x00, Name: CH4\_ERR\_REG

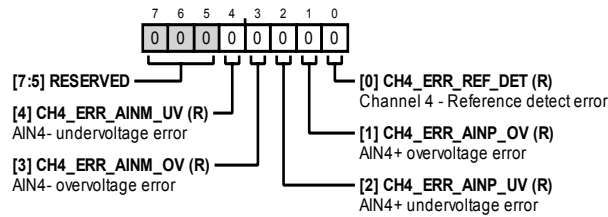

Table 124. Bit Descriptions for CH4\_ERR\_REG

Bits	Bit Name	Settings	Description	Reset	Access
[7:5]	RESERVED		Reserved	0x0	R/W
4	CH4_ERR_AINM_UV		Channel 4—AIN4– Undervoltage Error	0x0	R
3	CH4_ERR_AINM_OV		Channel 4—AIN4– Overvoltage Error	0x0	R
2	CH4_ERR_AINP_UV		Channel 4—AIN4+ Undervoltage Error	0x0	R
1	CH4_ERR_AINP_OV		Channel 4—AIN4+ Overvoltage Error	0x0	R
0	CH4_ERR_REF_DET		Channel 4—Reference Detect Error	0x0	R

**CHANNEL 5 STATUS REGISTER**

Address: 0x051, Reset: 0x00, Name: CH5\_ERR\_REG

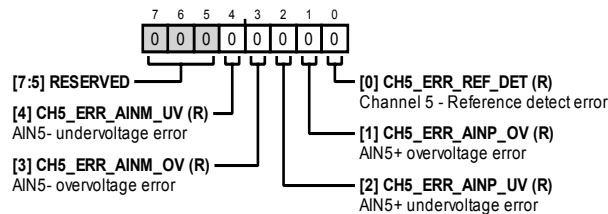

Table 125. Bit Descriptions for CH5\_ERR\_REG

Bits	Bit Name	Settings	Description	Reset	Access
[7:5]	RESERVED		Reserved	0x0	R/W
4	CH5_ERR_AINM_UV		Channel 5—AIN5– Undervoltage Error	0x0	R
3	CH5_ERR_AINM_OV		Channel 5—AIN5– Overvoltage Error	0x0	R
2	CH5_ERR_AINP_UV		Channel 5—AIN5+ Undervoltage Error	0x0	R
1	CH5_ERR_AINP_OV		Channel 5—AIN5+ Overvoltage Error	0x0	R
0	CH5_ERR_REF_DET		Channel 5—Reference Detect Error	0x0	R

### CHANNEL 6 STATUS REGISTER

Address: 0x052, Reset: 0x00, Name: CH6\_ERR\_REG

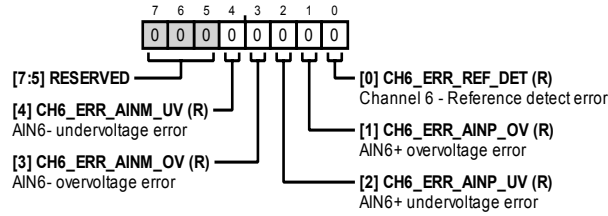

Table 126. Bit Descriptions for CH6\_ERR\_REG

Bits	Bit Name	Settings	Description	Reset	Access
[7:5]	RESERVED		Reserved	0x0	R/W
4	CH6_ERR_AINM_UV		Channel 6—AIN6– Undervoltage Error	0x0	R
3	CH6_ERR_AINM_OV		Channel 6—AIN6– Overvoltage Error	0x0	R
2	CH6_ERR_AINP_UV		Channel 6—AIN6+ Undervoltage Error	0x0	R
1	CH6_ERR_AINP_OV		Channel 6—AIN6+ Overvoltage Error	0x0	R
0	CH6_ERR_REF_DET		Channel 6—Reference Detect Error	0x0	R

### CHANNEL 7 STATUS REGISTER

Address: 0x053, Reset: 0x00, Name: CH7\_ERR\_REG

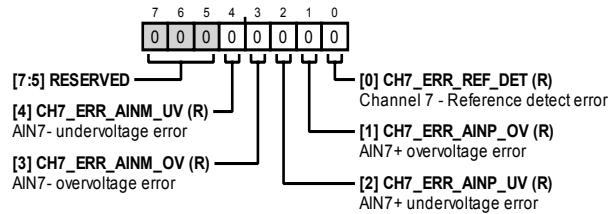

Table 127. Bit Descriptions for CH7\_ERR\_REG

Bits	Bit Name	Settings	Description	Reset	Access
[7:5]	RESERVED		Reserved	0x0	R
4	CH7_ERR_AINM_UV		Channel 7—AIN7– Undervoltage Error	0x0	R
3	CH7_ERR_AINM_OV		Channel 7—AIN7– Overvoltage Error	0x0	R
2	CH7_ERR_AINP_UV		Channel 7—AIN7+ Undervoltage Error	0x0	R
1	CH7_ERR_AINP_OV		Channel 7—AIN7+ Overvoltage Error	0x0	R
0	CH7_ERR_REF_DET		Channel 7—Reference Detect Error	0x0	R

**CHANNEL 0/CHANNEL 1 DSP ERRORS REGISTER**

Address: 0x054, Reset: 0x00, Name: CH0\_1\_SAT\_ERR

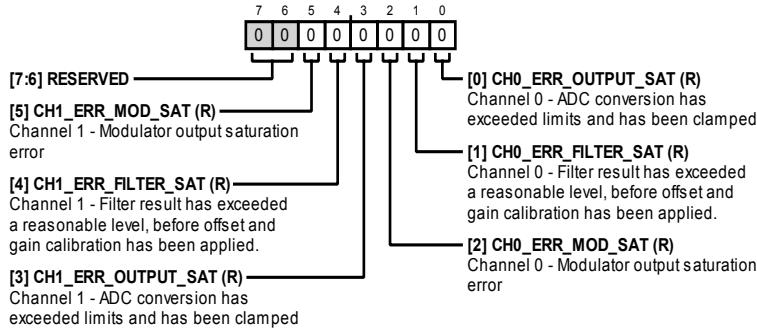

Table 128. Bit Descriptions for CH0\_1\_SAT\_ERR

Bits	Bit Name	Settings	Description	Reset	Access
[7:6]	RESERVED		Reserved	0x0	R
5	CH1_ERR_MOD_SAT		Channel 1—Modulator output saturation error	0x0	R
4	CH1_ERR_FILTER_SAT		Channel 1—Filter result has exceeded a reasonable level, before offset and gain calibration are applied	0x0	R
3	CH1_ERR_OUTPUT_SAT		Channel 1—ADC conversion has exceeded limits and is clamped	0x0	R
2	CH0_ERR_MOD_SAT		Channel 0—Modulator output saturation error	0x0	R
1	CH0_ERR_FILTER_SAT		Channel 0—Filter result has exceeded a reasonable level, before offset and gain calibration are applied	0x0	R
0	CH0_ERR_OUTPUT_SAT		Channel 0—ADC conversion has exceeded limits and is clamped	0x0	R

**CHANNEL 2/CHANNEL 3 DSP ERRORS REGISTER**

Address: 0x055, Reset: 0x00, Name: CH2\_3\_SAT\_ERR

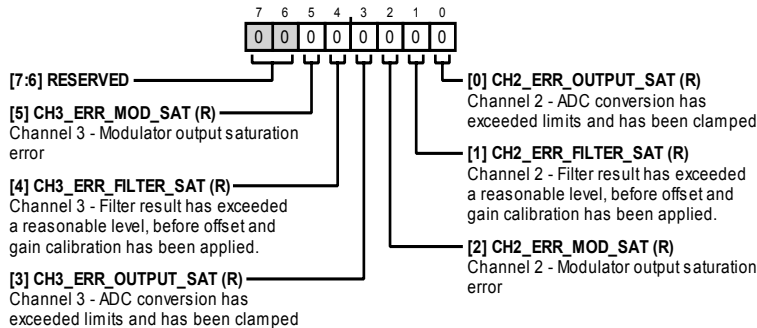

Table 129. Bit Descriptions for CH2\_3\_SAT\_ERR

Bits	Bit Name	Settings	Description	Reset	Access
[7:6]	RESERVED		Reserved	0x0	R
5	CH3_ERR_MOD_SAT		Channel 3—Modulator output saturation error	0x0	R
4	CH3_ERR_FILTER_SAT		Channel 3—Filter result has exceeded a reasonable level, before offset and gain calibration are applied	0x0	R
3	CH3_ERR_OUTPUT_SAT		Channel 3—ADC conversion has exceeded limits and is clamped	0x0	R
2	CH2_ERR_MOD_SAT		Channel 2—Modulator output saturation error	0x0	R
1	CH2_ERR_FILTER_SAT		Channel 2—Filter result has exceeded a reasonable level, before offset and gain calibration are applied	0x0	R
0	CH2_ERR_OUTPUT_SAT		Channel 2—ADC conversion has exceeded limits and is clamped	0x0	R

**CHANNEL 4/CHANNEL 5 DSP ERRORS REGISTER**

Address: 0x056, Reset: 0x00, Name: CH4\_5\_SAT\_ERR

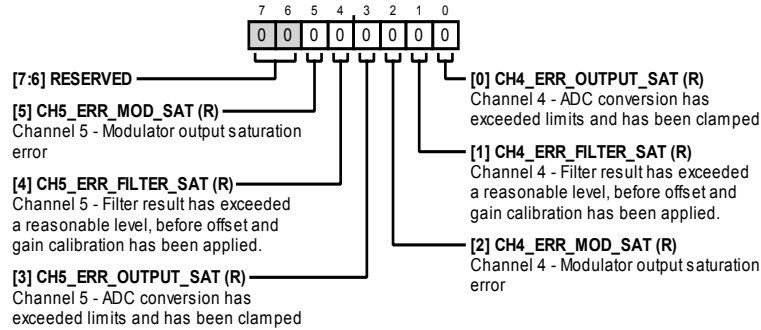

Table 130. Bit Descriptions for CH4\_5\_SAT\_ERR

Bits	Bit Name	Settings	Description	Reset	Access
[7:6]	RESERVED		Reserved	0x0	R
5	CH5_ERR_MOD_SAT		Channel 5—Modulator output saturation error	0x0	R
4	CH5_ERR_FILTER_SAT		Channel 5—Filter result has exceeded a reasonable level, before offset and gain calibration are applied	0x0	R
3	CH5_ERR_OUTPUT_SAT		Channel 5—ADC conversion has exceeded limits and is clamped	0x0	R
2	CH4_ERR_MOD_SAT		Channel 4—Modulator output saturation error	0x0	R
1	CH4_ERR_FILTER_SAT		Channel 4—Filter result has exceeded a reasonable level, before offset and gain calibration are applied	0x0	R
0	CH4_ERR_OUTPUT_SAT		Channel 4—ADC conversion has exceeded limits and is clamped	0x0	R

**CHANNEL 6/CHANNEL 7 DSP ERRORS REGISTER**

Address: 0x057, Reset: 0x00, Name: CH6\_7\_SAT\_ERR

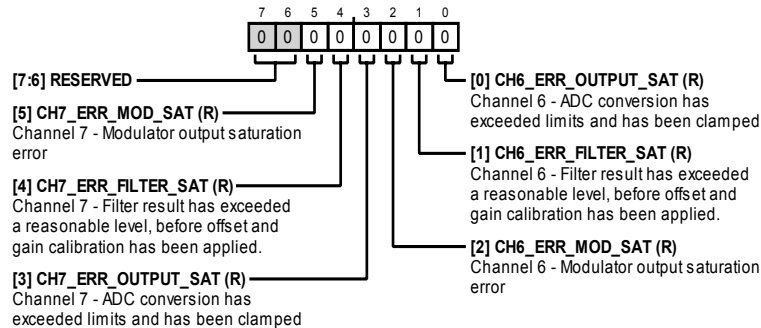

Table 131. Bit descriptions for CH6\_7\_SAT\_ERR

Bits	Bit Name	Settings	Description	Reset	Access
[7:6]	RESERVED		Reserved	0x0	R
5	CH7_ERR_MOD_SAT		Channel 7—Modulator output saturation error	0x0	R
4	CH7_ERR_FILTER_SAT		Channel 7—Filter result has exceeded a reasonable level, before offset and gain calibration are applied	0x0	R
3	CH7_ERR_OUTPUT_SAT		Channel 7—ADC conversion has exceeded limits and is clamped	0x0	R
2	CH6_ERR_MOD_SAT		Channel 6—Modulator output saturation error	0x0	R
1	CH6_ERR_FILTER_SAT		Channel 6—Filter result has exceeded a reasonable level, before offset and gain calibration are applied	0x0	R
0	CH6_ERR_OUTPUT_SAT		Channel 6—ADC conversion has exceeded limits and is clamped	0x0	R

**CHANNEL 0 TO CHANNEL 7 ERROR REGISTER ENABLE REGISTER**

Address: 0x058, Reset: 0xFE, Name: CHX\_ERR\_REG\_EN

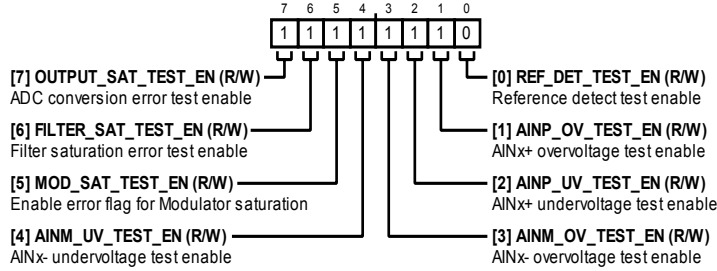

Table 132. Bit Descriptions for CHX\_ERR\_REG\_EN

Bits	Bit Name	Settings	Description	Reset	Access
7	OUTPUT_SAT_TEST_EN		ADC Conversion Error Test Enable	0x1	R/W
6	FILTER_SAT_TEST_EN		Filter Saturation Test Enable	0x1	R/W
5	MOD_SAT_TEST_EN		Enable Error Flag for Modulator Saturation	0x1	R/W
4	AINM_UV_TEST_EN		AINx– Undervoltage Test Enable	0x1	R/W
3	AINM_OV_TEST_EN		AINx– Overvoltage Test Enable	0x1	R/W
2	AINP_UV_TEST_EN		AINx+ Undervoltage Test Enable	0x1	R/W
1	AINP_OV_TEST_EN		AINx+ Overvoltage Test Enable	0x1	R/W
0	REF_DET_TEST_EN		Reference Detect Test Enable	0x0	R/W

**GENERAL ERRORS REGISTER 1**

Address: 0x059, Reset: 0x00, Name: GEN\_ERR\_REG\_1

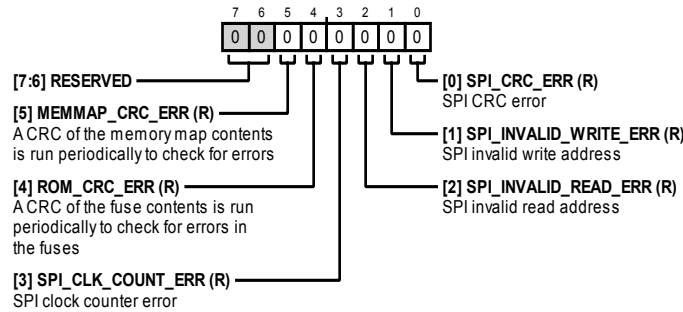

Table 133. Bit Descriptions for GEN\_ERR\_REG\_1

Bits	Bit Name	Settings	Description	Reset	Access
[7:6]	RESERVED		Reserved	0x0	R
5	MEMMAP_CRC_ERR		A CRC of the memory map contents is run periodically to check for errors	0x0	R
4	ROM_CRC_ERR		A CRC of the fuse contents is run periodically to check for errors in the fuses	0x0	R
3	SPI_CLK_COUNT_ERR		SPI clock counter error	0x0	R
2	SPI_INVALID_READ_ERR		SPI invalid read address	0x0	R
1	SPI_INVALID_WRITE_ERR		SPI invalid write address	0x0	R
0	SPI_CRC_ERR		SPI CRC error	0x0	R

**GENERAL ERRORS REGISTER 1 ENABLE**

Address: 0x05A, Reset: 0x3E, Name: GEN\_ERR\_REG\_1\_EN

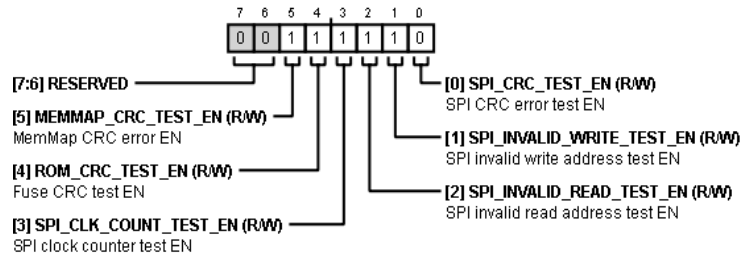

Table 134. Bit Descriptions for GEN\_ERR\_REG\_1\_EN

Bits	Bit Name	Settings	Description	Reset	Access
[7:6]	RESERVED		Reserved	0x0	R
5	MEMMAP_CRC_TEST_EN		Memory Map CRC Error Enable	0x1	R/W
4	ROM_CRC_TEST_EN		Fuse CRC Test Enable	0x1	R/W
3	SPI_CLK_COUNT_TEST_EN		SPI Clock Counter Test Enable	0x1	R/W
2	SPI_INVALID_READ_TEST_EN		SPI Invalid Read Address Test Enable	0x1	R/W
1	SPI_INVALID_WRITE_TEST_EN		SPI Invalid Write Address Test Enable	0x1	R/W
0	SPI_CRC_TEST_EN		SPI CRC Error Test Enable	0x0	R/W

**GENERAL ERRORS REGISTER 2**

Address: 0x05B, Reset: 0x00, Name: GEN\_ERR\_REG\_2

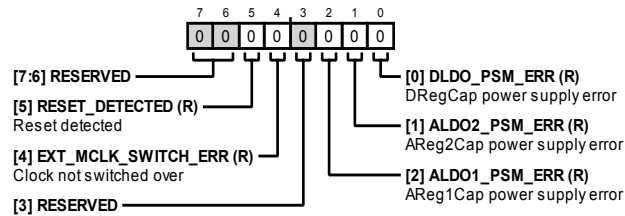

Table 135. Bit Descriptions for GEN\_ERR\_REG\_2

Bits	Bit Name	Settings	Description	Reset	Access
[7:6]	RESERVED		Reserved	0x0	R
5	RESET_DETECTED		Reset Detected	0x0	R
4	EXT_MCLK_SWITCH_ERR		Clock Not Switched Over	0x0	R
3	RESERVED		Reserved	0x0	R
2	ALDO1_PSM_ERR		AREG1CAP Power Supply Error	0x0	R
1	ALDO2_PSM_ERR		AREG2CAP Power Supply Error	0x0	R
0	DLDO_PSM_ERR		DREGCAP Power Supply Error	0x0	R

**GENERAL ERRORS REGISTER 2 ENABLE**

Address: 0x05C, Reset: 0x3C, Name: GEN\_ERR\_REG\_2\_EN

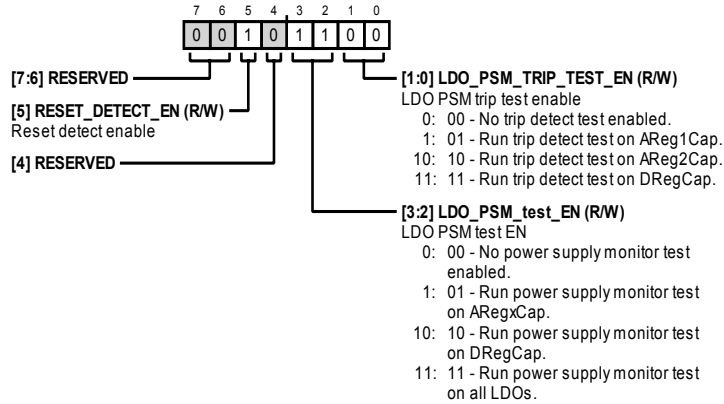

Table 136. Bit Descriptions for GEN\_ERR\_REG\_2\_EN

Bits	Bit Name	Settings	Description	Reset	Access
[7:6]	RESERVED		Reserved	0x0	R
5	RESET_DETECT_EN		Reset Detect Enable	0x1	R/W
4	RESERVED		Reserved	0x1	R/W
[3:2]	LDO_PSM_TEST_EN	0 1 10 11	LDO PSM Test EN 00—no power supply monitor test enabled 01—run power supply monitor test on AREGxCAP 10—run power supply monitor test on DREGCAP 11—run power supply monitor test on all LDOs	0x3	R/W
[1:0]	LDO_PSM_TRIP_TEST_EN	0 1 10 11	LDO PSM Trip Test Enable 00—no trip detect test enabled 01—run trip detect test on AREG1CAP 10—run trip detect test on AREG2CAP 11—run trip detect test on DREGCAP	0x0	R/W

**ERROR STATUS REGISTER 1**

Address: 0x05D, Reset: 0x00, Name: STATUS\_REG\_1

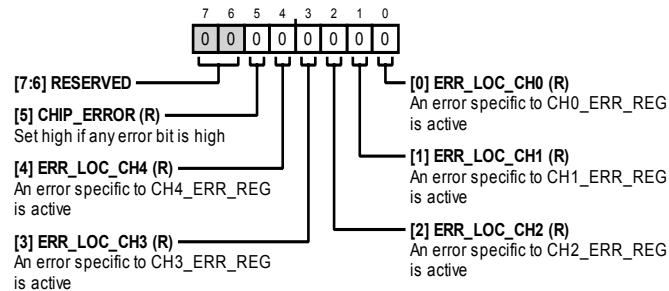

Table 137. Bit Descriptions for STATUS\_REG\_1

Bits	Bit Name	Settings	Description	Reset	Access
[7:6]	RESERVED		Reserved	0x0	R
5	CHIP_ERROR		Set this bit high if any error bit is high	0x0	R
4	ERR_LOC_CH4		An error specific to CH4_ERR_REG is active	0x0	R
3	ERR_LOC_CH3		An error specific to CH3_ERR_REG is active	0x0	R
2	ERR_LOC_CH2		An error specific to CH2_ERR_REG is active	0x0	R
1	ERR_LOC_CH1		An error specific to CH1_ERR_REG is active	0x0	R
0	ERR_LOC_CH0		An error specific to CH0_ERR_REG is active	0x0	R

### ERROR STATUS REGISTER 2

Address: 0x05E, Reset: 0x00, Name: STATUS\_REG\_2

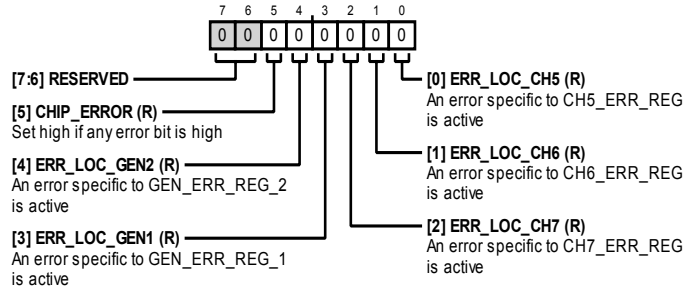

Table 138. Bit Descriptions for STATUS\_REG\_2

Bits	Bit Name	Settings	Description	Reset	Access
[7:6]	RESERVED		Reserved	0x0	R
5	CHIP_ERROR		Set high if any error bit is high	0x0	R
4	ERR_LOC_GEN2		An error specific to GEN_ERR_REG_2 is active	0x0	R
3	ERR_LOC_GEN1		An error specific to GEN_ERR_REG_1 is active	0x0	R
2	ERR_LOC_CH7		An error specific to CH7_ERR_REG is active	0x0	R
1	ERR_LOC_CH6		An error specific to CH6_ERR_REG is active	0x0	R
0	ERR_LOC_CH5		An error specific to CH5_ERR_REG is active	0x0	R

### ERROR STATUS REGISTER 3

Address: 0x05F, Reset: 0x00, Name: STATUS\_REG\_3

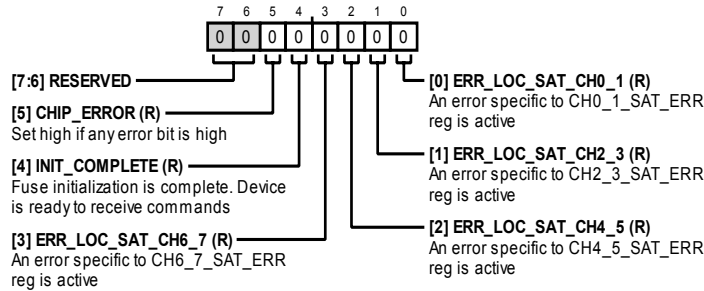

Table 139. Bit Descriptions for STATUS\_REG\_3

Bits	Bit Name	Settings	Description	Reset	Access
[7:6]	RESERVED		Reserved	0x0	R
5	CHIP_ERROR		Set high if any error bit is high.	0x0	R
4	INIT_COMPLETE		Fuse initialization is complete. Device is ready to receive commands.	0x0	R
3	ERR_LOC_SAT_CH6_7		An error specific to CH6_7_SAT_ERR register is active.	0x0	R
2	ERR_LOC_SAT_CH4_5		An error specific to CH4_5_SAT_ERR register is active.	0x0	R
1	ERR_LOC_SAT_CH2_3		An error specific to CH2_3_SAT_ERR register is active.	0x0	R
0	ERR_LOC_SAT_CH0_1		An error specific to CH0_1_SAT_ERR register is active.	0x0	R

### DECIMATION RATE (N) MSB REGISTER

Address: 0x060, Reset: 0x00, Name: SRC\_N\_MSB

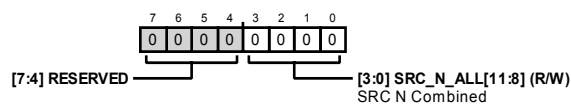

Table 140. Bit Descriptions for SRC\_N\_MSB

Bits	Bit Name	Settings	Description	Reset	Access
[7:4]	RESERVED		Reserved	0x0	R
[3:0]	SRC_N_ALL[11:8]		SRC N Combined	0x0	R/W



**DECIMATION RATE (N) LSB REGISTER**

Address: 0x061, Reset: 0x80, Name: SRC\_N\_LSB

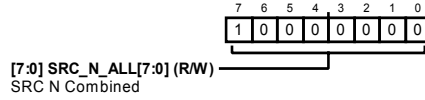

Table 141. Bit Descriptions for SRC\_N\_LSB

Bits	Bit Name	Settings	Description	Reset	Access
[7:0]	SRC_N_ALL[7:0]		SRC N Combined	0x0	R/W

**DECIMATION RATE (IF) MSB REGISTER**

Address: 0x062, Reset: 0x00, Name: SRC\_IF\_MSB

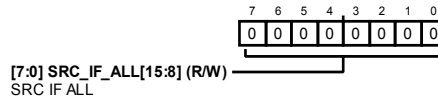

Table 142. Bit Descriptions for SRC\_IF\_MSB

Bits	Bit Name	Settings	Description	Reset	Access
[7:0]	SRC_IF_ALL[15:8]		SRC IF All	0x0	R/W

**DECIMATION RATE (IF) LSB REGISTER**

Address: 0x063, Reset: 0x00, Name: SRC\_IF\_LSB

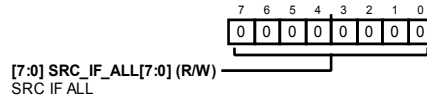

Table 143. Bit Descriptions for SRC\_IF\_LSB

Bits	Bit Name	Settings	Description	Reset	Access
[7:0]	SRC_IF_ALL[7:0]		SRC IF All	0x0	R/W

**SRC LOAD SOURCE AND LOAD UPDATE REGISTER**

Address: 0x064, Reset: 0x00, Name: SRC\_UPDATE

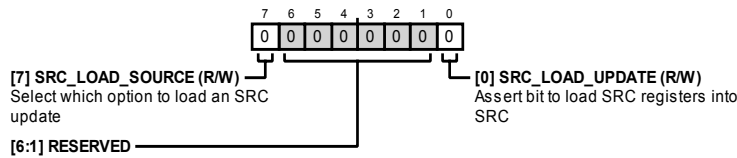
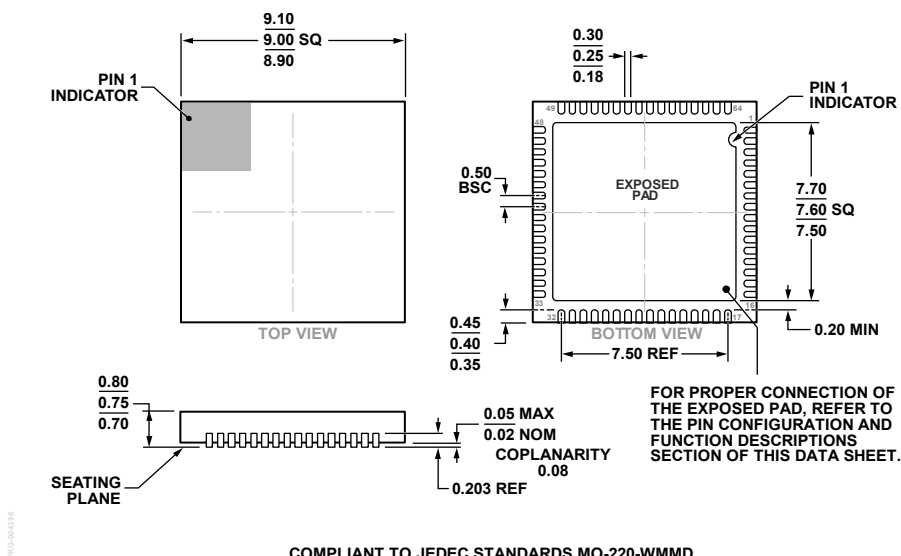

Table 144. Bit Descriptions for SRC\_UPDATE

Bits	Bit Name	Settings	Description	Reset	Access
7	SRC_LOAD_SOURCE		Selects which option to load an SRC update	0x0	R/W
[6:1]	RESERVED		Reserved	0x0	R
0	SRC_LOAD_UPDATE		Asserts bit to load SRC registers into SRC	0x0	R/W

# OUTLINE DIMENSIONS



COMPLIANT TO JEDEC STANDARDS MO-220-WMMD

Figure 121. 64-Lead Lead Frame Chip Scale Package [LFCSP]  
 9 mm × 9 mm Body and 0.75 mm Package Height  
 (CP-64-15)

Dimensions shown in millimeters

## ORDERING GUIDE

Model <sup>1</sup>	Temperature Range	Package Description	Package Option
AD7770ACPZ	-40°C to +125°C	64-Lead Lead Frame Chip Scale Package [LFCSP]	CP-64-15
AD7770ACPZ-RL	-40°C to +125°C	64-Lead Lead Frame Chip Scale Package [LFCSP]	CP-64-15
EVAL-AD7770FMCZ		Evaluation Board	

<sup>1</sup> Z = RoHS Compliant Part.