

Programmable Voltage Controlled Oscillator (VCXO)

OUTPUT: LV-PECL
VG7050ECN

NEW

- Frequency range : 50 MHz to 800 MHz
(Tuning resolution: $2.2 \sim 2.8 \times 10^{-9}$)
- Supply voltage : 2.5 V / 3.3 V
- External dimensions : 7.0 × 5.0 × 1.5 mm (10 pins)
- Absolute Pull Range : ± 0 to $\pm 180 \times 10^{-6}$ (12 steps selectable)

Features

- User-specified four startup frequency, APR and 7-bit I²C address
- User Programming : I²C Interface
- Low jitter PLL technology

Applications

SONET/SDH, OTN, GbE, Fibre Channel



Product Number (please contact us)
X1G004561xxxx00



Actual size



Specifications (characteristics)

Item	Symbol	Specifications	Conditions / Remarks
Output frequency range	f _o	50 MHz to 800 MHz	It can be changed by I ² C
Supply voltage	V _{CC}	D: 2.5 V ± 0.125 V, C: 3.3 V ± 0.33 V	
Storage temperature	T _{stg}	-55 °C to +125 °C	Storage as single product
Operating temperature	T _{use}	-40 °C to +85 °C	
Frequency tolerance *1	f _{tol}	±50 × 10 ⁻⁶ Max.	Includes frequency aging (10 years)
Current consumption	I _{CC}	90 mA Max.	OE Active, L _{ECL} =50 Ω
Disable current	I _{dis}	40 mA Max.	OE Inactive, Output Standby: Hi-Z mode
		70 mA Max.	OE Inactive, Output Standby: Fix mode
Absolute pull range	APR	±0 to ±180 × 10 ⁻⁶	V _c = 1.65 V ± 1.35 V (V _{CC} = 3.3 V)
		±0 to ±180 × 10 ⁻⁶	V _c = 1.25 V ± 1.00 V (V _{CC} = 2.5 V)
Control voltage tuning range	V _c	0 to V _{CC}	
Frequency change polarity	-	Positive slope	0 to V _{CC}
Symmetry	SYM	45 % to 55 %	At outputs crossing point
Output voltage	V _{OH}	V _{CC} -1.025 V Min.	DC characteristics
	V _{OL}	V _{CC} -1.62 V Max.	
Output load condition	L _{ECL}	50 Ω	Termination to V _{CC} - 2.0 V
Input voltage	V _{IH}	70% V _{CC} Min.	OE, FSEL0, FSEL1, SDA and SCL
	V _{IL}	30% V _{CC} Max.	
Rise time / Fall time	tr/tf	400 ps Max.	Between 20% and 80% of (V _{OH} -V _{OL})
Start-up time	t _{str}	10 ms Max.	Time at minimum supply voltage to be 0 s

*1 Frequency tolerance includes initial frequency tolerance, temperature variation, supply voltage change, reflow drift and 10 years aging at +25 °C.

Product name VG7050 ECN SM20xxxx C J G H P Z
(Standard form) ① ② ③ ④ ⑤ ⑥ ⑦ ⑧ ⑨

- ① Model
- ② Output (E: LV-PECL)
- ③ Parameter Designator (VG7050ECN: SM20xxxx)
- ④ Supply voltage (C: 3.3 V Typ., D: 2.5 V Typ.)
- ⑤ Frequency tolerance (J: $\pm 50 \times 10^{-6}$)
- ⑥ Operating temperature (G: -40 ~ +85°C)
- ⑦ OE Function (H: Active High, L: Active Low)
- ⑧ Absolute Pull Range (P: Programmable)
- ⑨ Output Standby Type (F: Fix (OUT="L", OUTN="H"), Z: High-Z)

Phase Jitter

	Offset Frequency	125.00 MHz	156.25 MHz	250.00 MHz	425.00 MHz	622.08 MHz	669.33 MHz	794.73 MHz
Phase jitter*2 Typ.	12 kHz to 20 MHz	0.30 ps	0.26 ps	0.26 ps	0.25 ps	0.26 ps	0.26 ps	0.26 ps
	20 kHz to 50 MHz	0.30 ps	0.27 ps	0.27 ps	0.26 ps	0.27 ps	0.27 ps	0.27 ps
	50 kHz to 80 MHz	0.29 ps	0.27 ps	0.27 ps	0.26 ps	0.27 ps	0.27 ps	0.27 ps

*2 In order to achieve optimum jitter performance, it is recommended that the capacitor (0.1 μF + 10 μF) between V_{CC} and GND pin should be placed as close to the V_{CC} pin as possible.

Block diagram

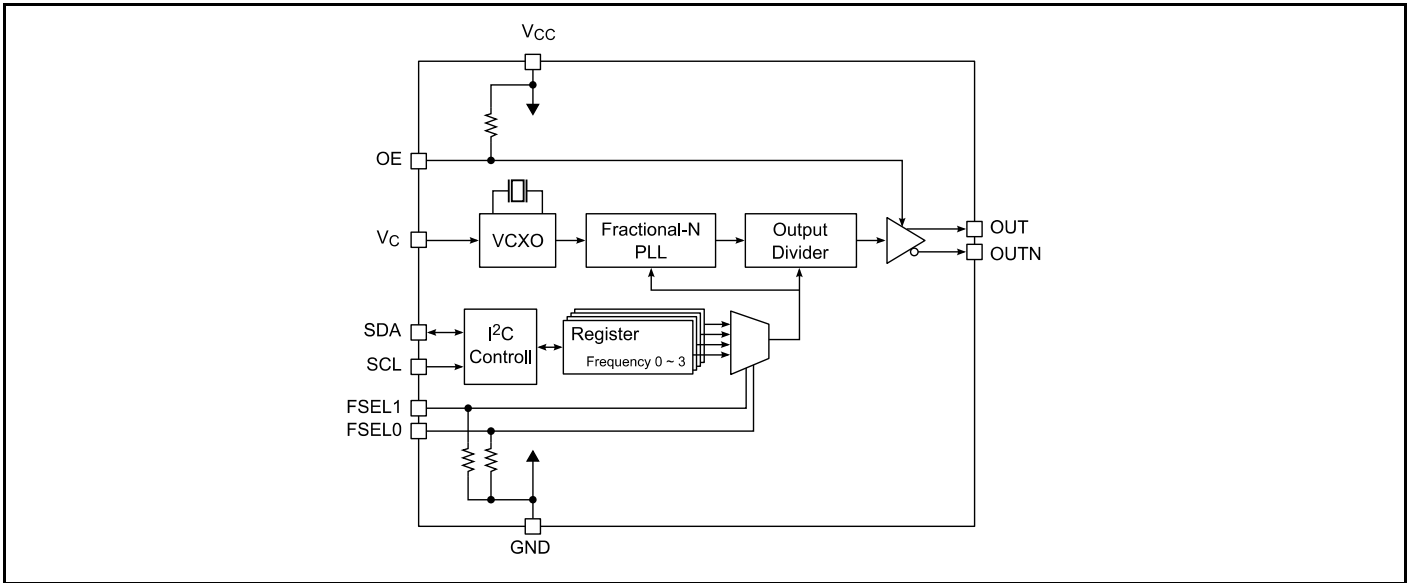

OE Function / OE Standby Type

OE Function	OE Standby Type	Frequency output OE pin	Oscillator Stop	
			OE pin	OUT,OUTN state
H: Active High	Z: High-Z	"H" or "OPEN"	"L"	High Impedance
L: Active Low		"L" or "OPEN"	"H"	
H: Active High	F: Fix	"H" or "OPEN"	"L"	OUT="L", OUTN="H"
L: Active Low		"L" or "OPEN"	"H"	

External dimensions

(Unit: mm)

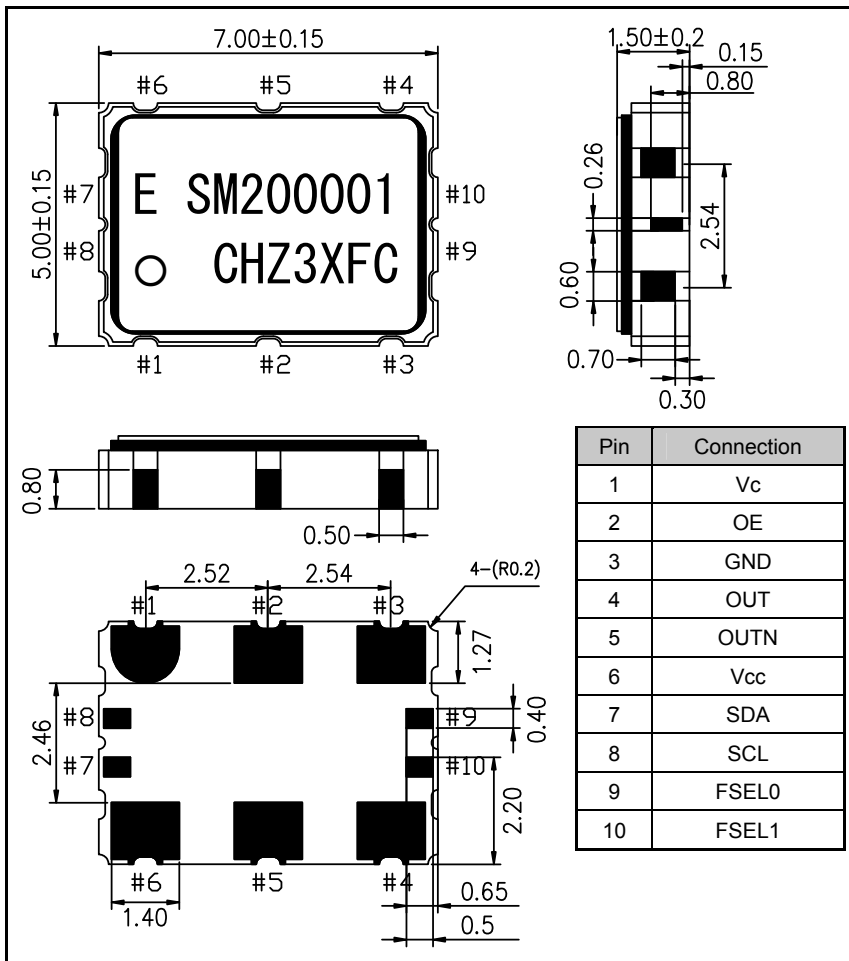

Footprint (Recommended)

(Unit: mm)

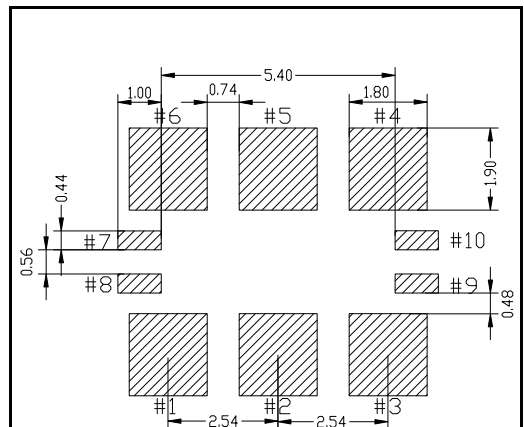

In order to achieve optimum jitter performance, it is recommended that the capacitor (0.1 μ F + 10 μ F) between VCC and GND pin should be placed as close to the VCC pin as possible.

PROMOTION OF ENVIRONMENTAL MANAGEMENT SYSTEM CONFORMING TO INTERNATIONAL STANDARDS

At Seiko Epson, all environmental initiatives operate under the Plan-Do-Check-Action (PDCA) cycle designed to achieve continuous improvements. The environmental management system (EMS) operates under the ISO 14001 environmental management standard.

All of our major manufacturing and non-manufacturing sites, in Japan and overseas, completed the acquisition of ISO 14001 certification.

ISO 14000 is an international standard for environmental management that was established by the International Standards Organization in 1996 against the background of growing concern regarding global warming, destruction of the ozone layer, and global deforestation.





WORKING FOR HIGH QUALITY

In order provide high quality and reliable products and services than meet customer needs,

Seiko Epson made early efforts towards obtaining ISO9000 series certification and has acquired ISO9001 for all business establishments in Japan and abroad. We have also acquired ISO/TS 16949 certification that is requested strongly by major automotive manufacturers as standard.

ISO/TS16949 is the international standard that added the sector-specific supplemental requirements for automotive industry based on ISO9001.

► Explanation of the mark that are using it for the catalog

	► Pb free.
	► Complies with EU RoHS directive. *About the products without the Pb-free mark. Contains Pb in products exempted by EU RoHS directive. (Contains Pb in sealing glass, high melting temperature type solder or other.)
	► Designed for automotive applications such as Car Multimedia, Body Electronics, Remote Keyless Entry etc.
	► Designed for automotive applications related to driving safety (Engine Control Unit, Air Bag, ESC etc.)

Notice

- This material is subject to change without notice.
- Any part of this material may not be reproduced or duplicated in any form or any means without the written permission of Seiko Epson.
- The information about applied circuitry, software, usage, etc. written in this material is intended for reference only. Seiko Epson does not assume any liability for the occurrence of infringing on any patent or copyright of a third party. This material does not authorize the licensing for any patent or intellectual copyrights.
- When exporting the products or technology described in this material, you should comply with the applicable export control laws and regulations and follow the procedures required by such laws and regulations.
- You are requested not to use the products (and any technical information furnished, if any) for the development and/or manufacture of weapon of mass destruction or for other military purposes. You are also requested that you would not make the products available to any third party who may use the products for such prohibited purposes.
- These products are intended for general use in electronic equipment. When using them in specific applications that require extremely high reliability, such as the applications stated below, you must obtain permission from Seiko Epson in advance.
/ Space equipment (artificial satellites, rockets, etc.) / Transportation vehicles and related (automobiles, aircraft, trains, vessels, etc.) / Medical instruments to sustain life / Submarine transmitters / Power stations and related / Fire work equipment and security equipment / traffic control equipment / and others requiring equivalent reliability.
- All brands or product names mentioned herein are trademarks and/or registered trademarks of their respective.