



Thyristor Module

VRRM / VDRM 800 to 1800V
ITAV 110A

Applications

- Power Converters
- Lighting Control
- DC Motor Control and Drives
- Heat and temperature control

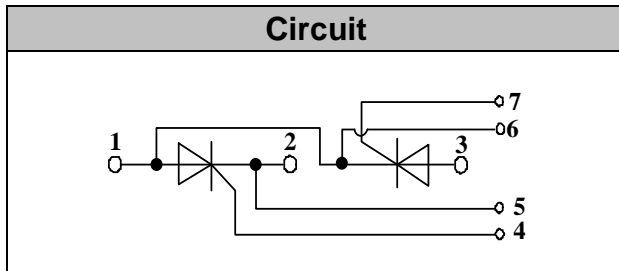

Features

- International standard package
- High Surge Capability
- Glass passivated chip
- Simple Mounting
- Heat transfer through aluminum oxide DBC ceramic isolated metal baseplate
- UL recognized applied for file no. E360040

Module Type

TYPE	VRRM	VRSM
MT110C08T1	800V	900V
MT110C12T1	1200V	1300V
MT110C16T1	1600V	1700V
MT110C18T1	1800V	1900V

Maximum Ratings

Symbol	Conditions	Values	Units
I_{TAV}	Sine 180°; $T_c=85^\circ\text{C}$	110	A
I_{TSM}	$T_{VJ}=45^\circ\text{C}$ $t=10\text{ms}$, sine $T_{VJ}=125^\circ\text{C}$ $t=10\text{ms}$, sine	2250 1900	A
i^2t	$T_{VJ}=45^\circ\text{C}$ $t=10\text{ms}$, sine $T_{VJ}=125^\circ\text{C}$ $t=10\text{ms}$, sine	25000 18000	A^2s
Visol	a.c.50HZ;r.m.s.;1min	3000	V
T_{vj}		-40 to 130	$^\circ\text{C}$
T_{stg}		-40 to 125	$^\circ\text{C}$
Mt	To terminals(M5)	$3 \pm 15\%$	Nm
Ms	To heatsink(M6)	$5 \pm 15\%$	Nm
di/dt	$T_{VJ}=T_{VJM}$, $2/3V_{DRM}$, $I_G=500\text{mA}$ $Tr<0.5\mu\text{s}$, $tp>6\mu\text{s}$	150	A/ μs
dv/dt	$T_J=T_{VJM}$, $2/3V_{DRM}$, linear voltage rise	1000	V/ μs
a	Maximum allowable acceleration	50	m/s^2
Weight	Module(Approximately)	100	g

Thermal Characteristics

Symbol	Conditions	Values	Units
$R_{th(j-c)}$	Cont.;per thyristor / per module	0.28/0.14	$^\circ\text{C/W}$
$R_{th(c-s)}$	per thyristor / per module	0.2/0.1	$^\circ\text{C/W}$



Electrical Characteristics

Symbol	Conditions	Values			Units
		Min.	Typ.	Max.	
V_{TM}	$T=25^{\circ}\text{C}$ $I_{TM}=300\text{A}$			1.65	V
I_{RRM}/I_{DRM}	$T_{VJ}=T_{VJM}$, $V_R=V_{RRM}$, $V_D=V_{DRM}$			20	mA
V_{TO}	For power-loss calculations only ($T_{VJ}=125^{\circ}\text{C}$)			0.9	V
r_T	$T_{VJ}=T_{VJM}$			2	m Ω
V_{GT}	$T_{VJ}=25^{\circ}\text{C}$, $V_D=6\text{V}$			3	V
I_{GT}	$T_{VJ}=25^{\circ}\text{C}$, $V_D=6\text{V}$			150	mA
V_{GD}	$T_{VJ}=125^{\circ}\text{C}$, $V_D=2/3V_{DRM}$			0.25	V
I_{GD}	$T_{VJ}=125^{\circ}\text{C}$, $V_D=2/3V_{DRM}$			6	mA
I_L	$T_{VJ}=25^{\circ}\text{C}$, $R_G=33\ \Omega$		300	600	mA
I_H	$T_{VJ}=25^{\circ}\text{C}$, $V_D=6\text{V}$		150	250	mA
tgd	$T_{VJ}=25^{\circ}\text{C}$, $I_G=1\text{A}$, $di_G/dt=1\text{A/us}$		1		us
tq	$T_{VJ}=T_{VJM}$		100		us



Performance Curves

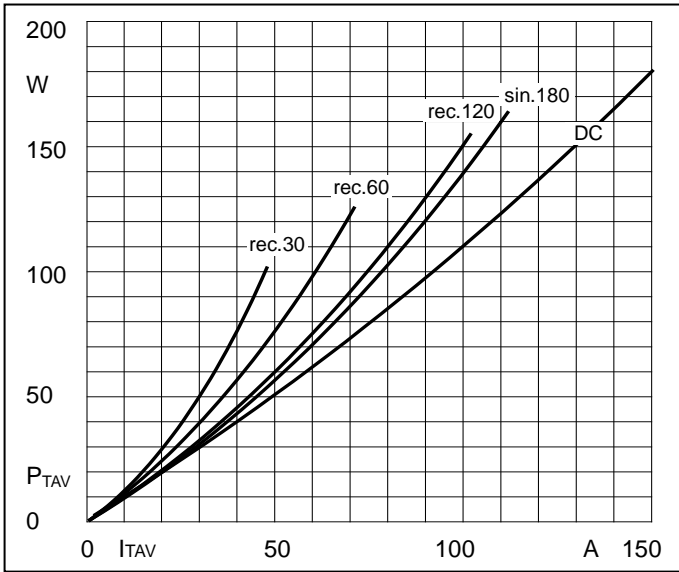

Fig1. Power dissipation

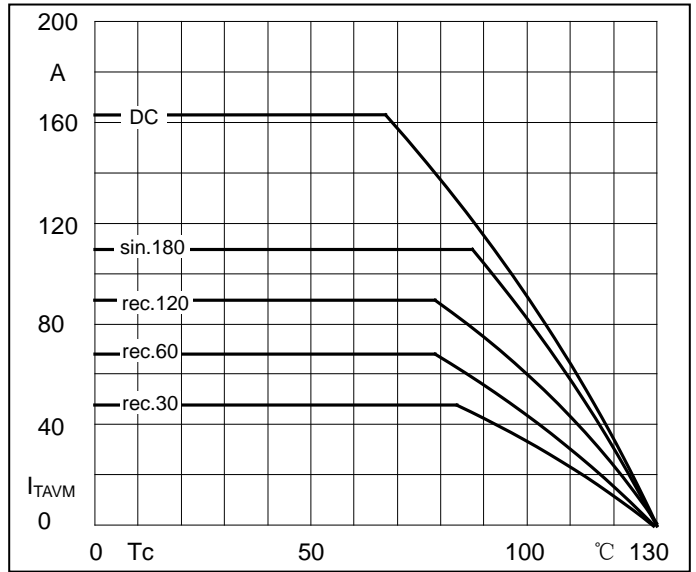

Fig2. Forward Current Derating Curve

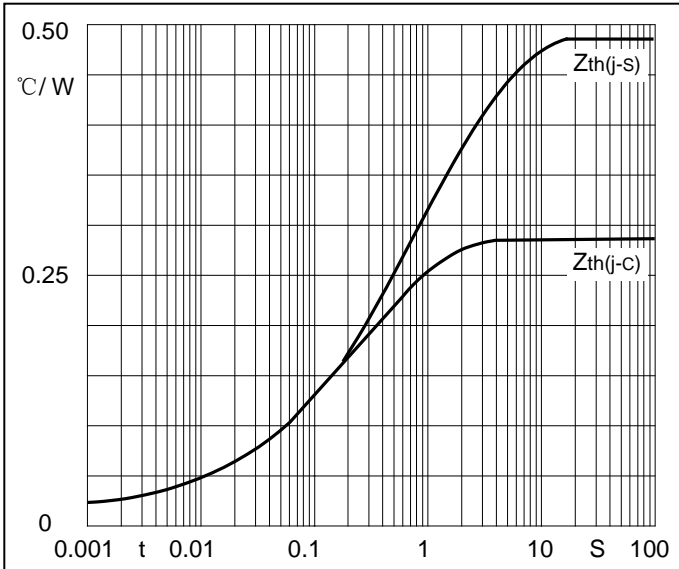

Fig3. Transient thermal impedance

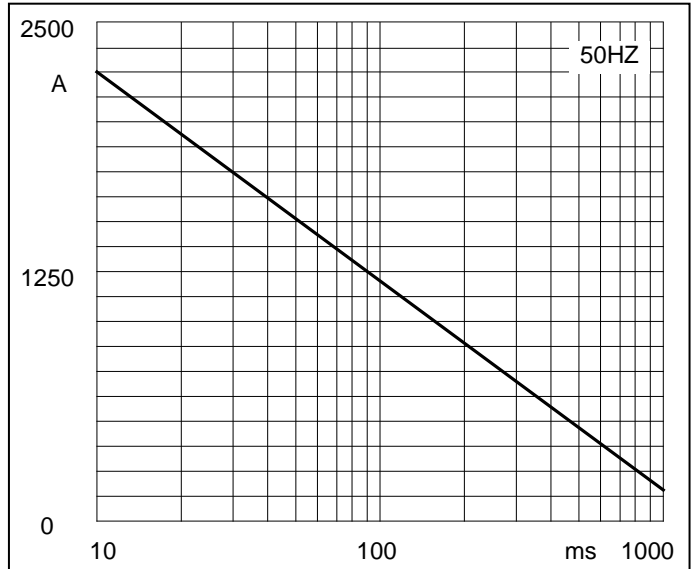

Fig4. Max Non-Repetitive Forward Surge Current

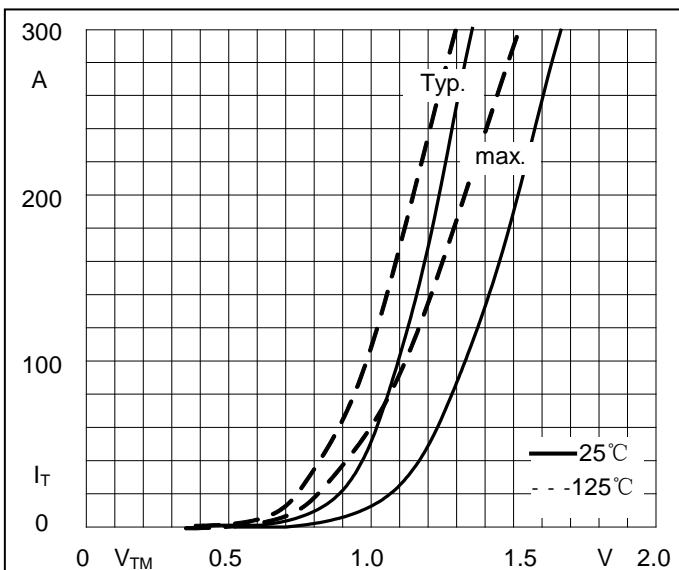

Fig5. Forward Characteristics

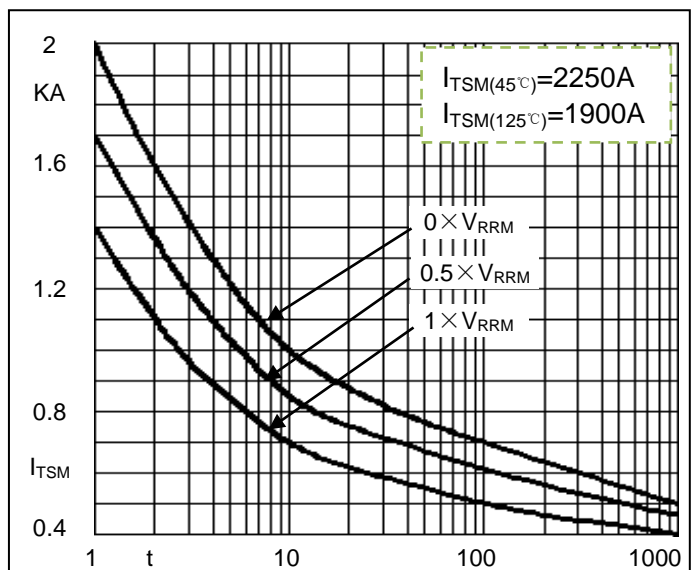

Fig6. Surge overload current vs. Cycles

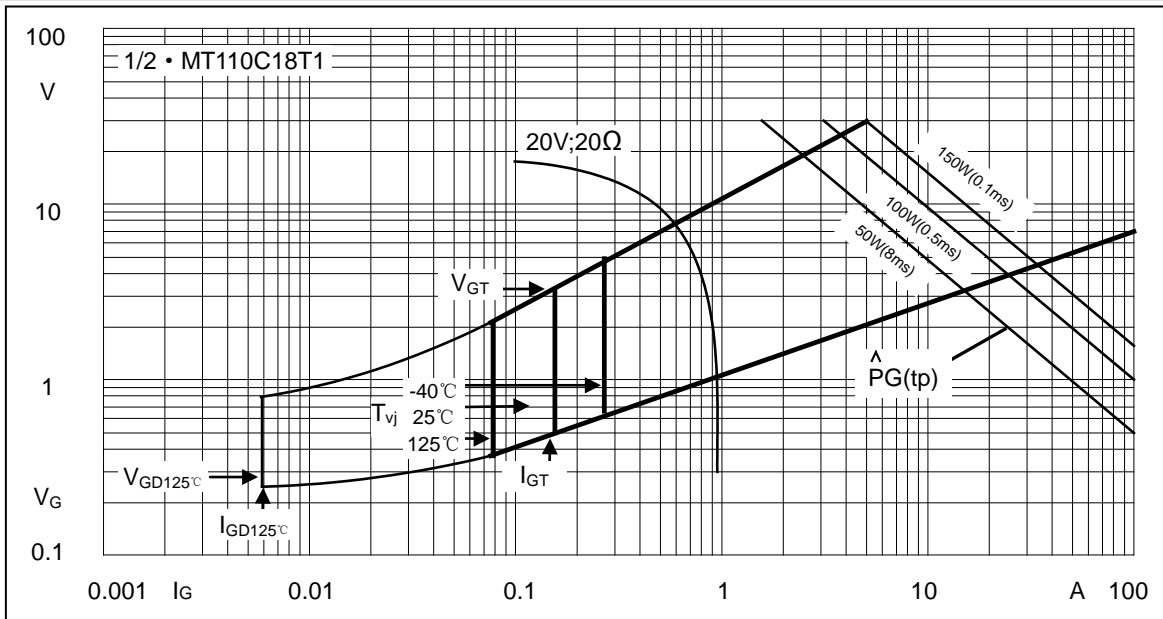
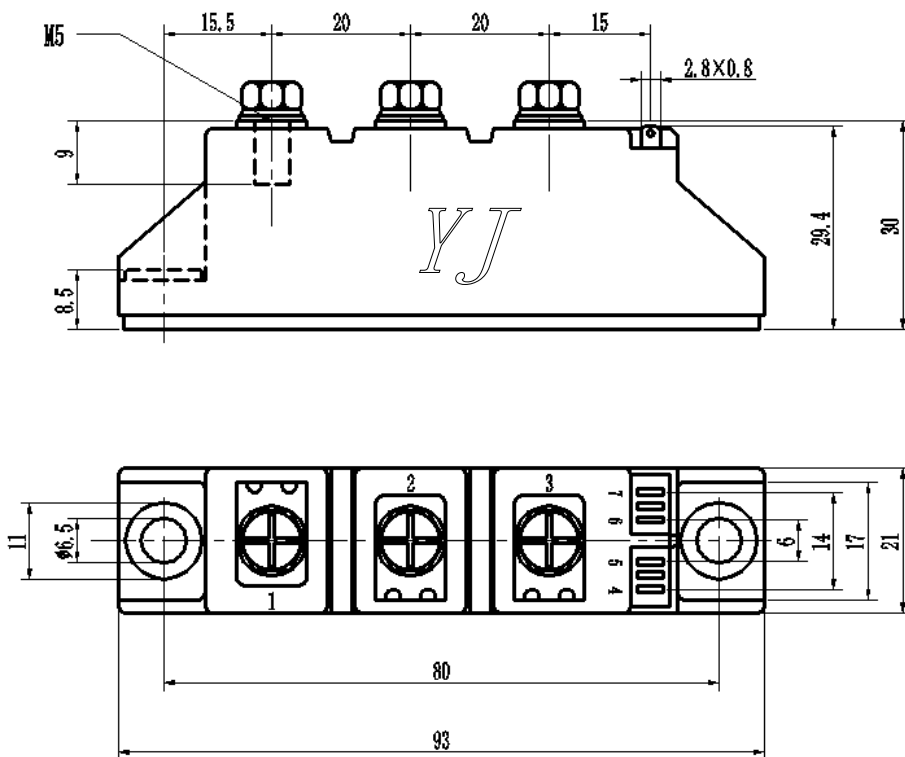

Fig7. Gate trigger Characteristics

Package Outline Information

CASE: T1



Dimensions in mm