

LTC3626EUDC
**20V, 2.5A Synchronous Monolithic
 Step-Down Regulator with Current
 and Temperature Monitoring**
DESCRIPTION

Demonstration circuit 1768A is a step-down converter, using the LTC3626 monolithic synchronous buck regulator, which has current and temperature monitoring capabilities. The 1768A has an input voltage range of 3.6V to 20V, and is capable of delivering up to 2.5A of output current. The output voltage of the 1768A can be set as low as 0.6V, the reference voltage of the LTC3626. At light load currents, the 1768A is capable of operating in Burst Mode™, which makes for greater efficiency, and during shutdown, it consumes less than 2µA of quiescent current. In continuous mode operation, the 1768A is a high efficiency circuit over 90%. The 1768A can also track another voltage with the LTC3626

track function. Because of the current and temperature monitoring and limiting capabilities of the LTC3626, the 1768A input or output current, as well as its maximum temperature can be limited or clamped. The 1768A uses low profile surface mount components, due to the high switching frequency capability of the LTC3626, which is programmable up to 3MHz. All these features make the 1768A an ideal circuit for use in industrial applications.

Design files for this circuit board are available at <http://www.linear.com/demo>

LT, LT, LTC, LTM, Burst Mode, Linear Technology and the Linear logo are registered trademarks of Linear Technology Corporation. All other trademarks are the property of their respective owners.

PERFORMANCE SUMMARY

PARAMETER	CONDITIONS	VALUE
Input Voltage Range		3.6V – 20V
Output Voltage Range		0.6V-6V
Run/Shutdown		GND = Shutdown V _{IN} = Run
Output Voltage Regulation	V _{IN} = 3.6V to 20V, I _{OUT} = 0A to 2.5A	1.2V ±2% Typ. (1.176V – 1.224V)
	V _{IN} = 3.6V to 20V, I _{OUT} = 0A to 2.5A	1.8V ±2% Typ. (1.764V – 1.836V)
	V _{IN} = 4V to 20V, I _{OUT} = 0A to 2.5A	3.3V ±2% Typ. (3.234V – 3.366V)
Typical Output Ripple Voltage	V _{IN} = 12V, V _{OUT} = 1.8V I _{OUT} = 2.5A (20MHz BW)	< 20mV _{p-p}
Burst Mode-to-Continuous Mode Transition Current Values	V _{IN} = 12V, V _{OUT} = 1.2V	I _{OUT} < 680mA
	V _{IN} = 12V, V _{OUT} = 1.8V	I _{OUT} < 880mA
	V _{IN} = 12V, V _{OUT} = 3.3V	I _{OUT} < 1.2A
Mode	Mode Pin = INTV _{CC}	Burst Mode
	Mode = GND	FCM (Forced Continuous Mode)
	Mode = Floating	Synchronized or Burst Mode
Nominal Switching Frequency	R _T = 324k	1MHz ±20%
	R _T connected to INTV _{CC}	2MHz ±30%

QUICK START PROCEDURE

Demonstration Circuit 1768A is easy to set up to evaluate the performance of the LTC3626. For proper measurement equipment configuration, set up the circuit according to the diagram in Figure 1. Before proceeding to test, check that the shunts are inserted into the default locations: 1.2V position of the output voltage header JP1, the SS position of the soft-start/track header JP5, the FCM (Forced Continuous Mode) position of the MODE header JP6, the ON position of RUN header JP7, the 1MHz position of the frequency header JP8, the EXT position of the I_{TH} header JP9, the SET/OFF position of the temperature set header JP10, the OFF position of the temp. monitoring header JP11, the OFF position of the output current monitoring header JP12, and the OFF position of the input current monitoring header JP13.

When measuring the input or output voltage ripple, care must be taken to avoid a long ground lead on the oscilloscope probe. Measure the input or output voltage ripple by touching the probe tip directly across the V_{IN} or V_{OUT} and GND terminals. See Figure 2 for proper scope probe measurement technique.

With the 1768A set up according to the proper measurement configuration and equipment in Figure 1, apply 6.3V at V_{IN} (Do not hot-plug V_{IN} or increase V_{IN} over the rated maximum supply voltage of 20V, or the part may be damaged.). Measure V_{OUT} ; it should read 1.2V (If desired, the quiescent current of the circuit can be monitored now by swapping the shunt in header JP7 into the OFF position.). The output voltage should be regulating. Measure V_{OUT} it should measure $1.2V \pm 1\%$ (1.188V to 1.212V).

Vary the input voltage from 3.6V to 20V and adjust the load current from 0 to 2.5A. V_{OUT} should regulate around $1.2V \pm 2\%$ (1.176V to 1.224V). Measure the output ripple voltage; it should measure less than 20mVAC. Set the input voltage to 12V and the output current to any current less than 1.25A. Observe the discontinuous mode of operation at the switch node, and measure the output ripple voltage. It should measure less than 50mV. Change the shunt position on the MODE header from BM to FCM (Forced Continuous Mode) and observe the voltage waveform at the switch pins (the other side of the inductor from the output). Verify the switching frequency is between 850kHz and 1.2MHz ($T = 1.17\mu s$ and 833ns), and that the switch node waveform is rectangular in shape.

Insert the JP7 shunt into the OFF position and move the shunt in the 1.2V output JP1 header into any of the two remaining output voltage option headers: 1.8V (JP2) or 3.3V (JP3). Just as in the 1.2V V_{OUT} test, the output voltage should read $V_{OUT} \pm 1\%$ tolerance under static line and load conditions and $\pm 1\%$ tolerance under dynamic line and load conditions $\pm 2\%$ total). Also, the circuit operation in discontinuous mode will be the same.

Monitor the input and output currents, and the die temperature, by changing the shunts on headers JP13, JP12, and JP11, respectively. The currents and temperature can even be limited using headers JP13, JP12, and JP10 – the TSET header, and adjusting the values of resistors R12, R13, and R14 (Consult the Input/Output Current and On-Die Temperature Monitor and Limit section of the LTC3626 datasheets for more details.).

When finished, turn off the circuit by inserting the shunt in header JP7 into the OFF position.

QUICK START PROCEDURE

Table 1. Jumper Description

JUMPER	FUNCTION	RANGE/SETTING (DEFAULT)
JP1	Output Voltage Setting.	1.2V
JP5	Soft-Start (TRACK or SS)	TRACK – (SS)
JP6	MODE/SYNC: Forced Continuous Mode (FCM), Burst Mode, or SYNC	(FCM) – BM – SYNC
JP7	RUN	(ON) – OFF
JP8	Frequency (FREQ)	(1MHz) – 2MHz
JP9	ITH: External Comp. (EXT) or Internal (INTV _{CC}) Comp. (INT)	(EXT) – INT
JP10	Temperature Setting (TSET): Externally Set (EXT SET) or Internally Set (INTV _{CC}) or Off (SET/OFF)	EXT SET – (SET/OFF)
JP11	Temperature Monitoring (TMON)	ON – (OFF)
JP12	Output Current Monitoring (I _{OUT})	ON – (OFF)
JP13	Input Current Monitoring (I _{IN})	ON – (OFF)

QUICK START PROCEDURE

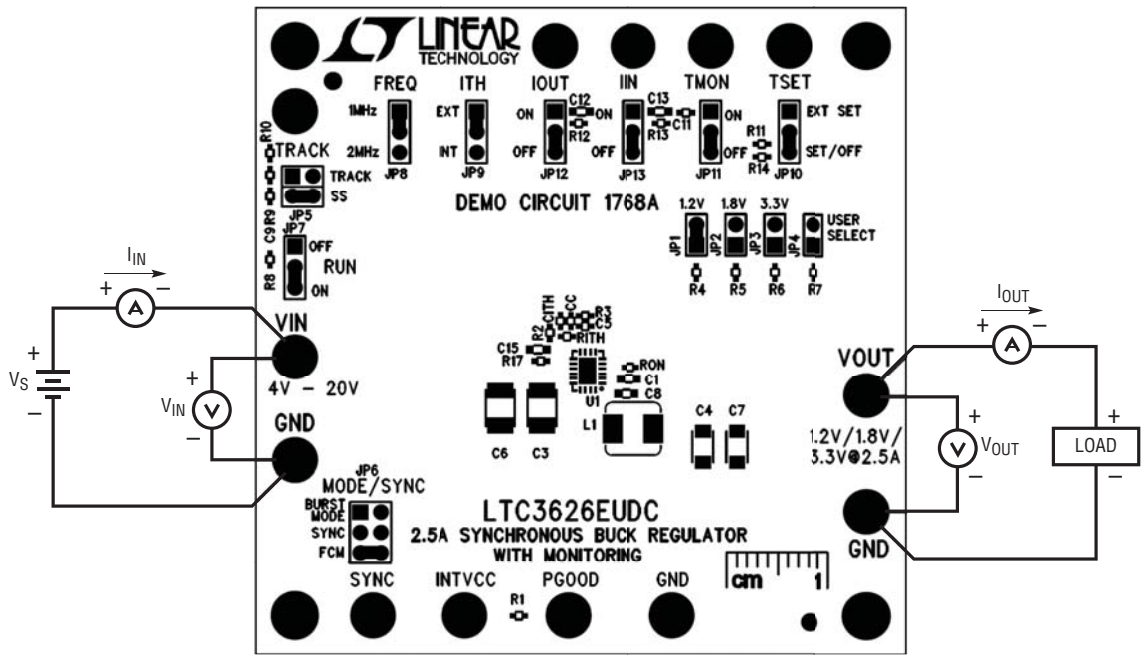

Figure 1. Proper Equipment Measurement Set-Up

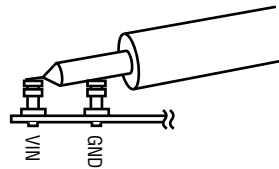

Figure 2. Measuring Input or Output Ripple

QUICK START PROCEDURE

Normal Switching Frequency and Output Ripple Voltage Waveforms

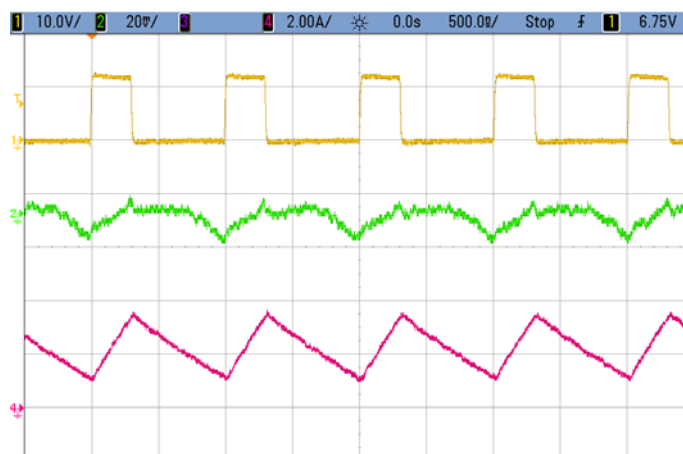

Figure 3. Switch Node Voltage, Output Ripple Voltage & Inductor Ripple Current Waveforms
 $V_{IN} = 12V$, $V_{OUT} = 3.3V$, $I_{OUT} = 2.5A$, $f_{SW} = 1MHz$ Trace 1: Switch Voltage (10V/DIV)
 Trace 2: Output Ripple Voltage (20mV/DIV AC) Trace 4: Inductor Ripple Current (2A/DIV)

Load Step Response Waveforms

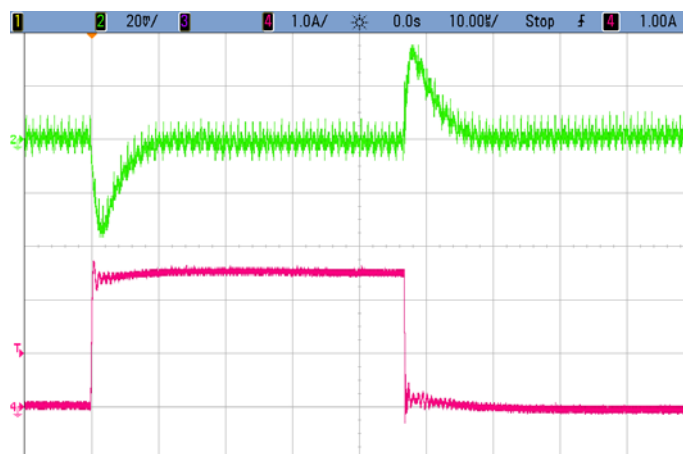

Figure 4. Load Step Response $V_{IN} = 12V$. $V_{OUT} = 1.2V$, 2.5A Load Step (0A-2.5A)
 Forced Continuous Mode, $f_{SW} = 1MHz$. Trace 2: Output Voltage (20mV/DIV AC)
 Trace 4: Output Current (1A/DIV)

QUICK START PROCEDURE

Load Step Response Waveforms

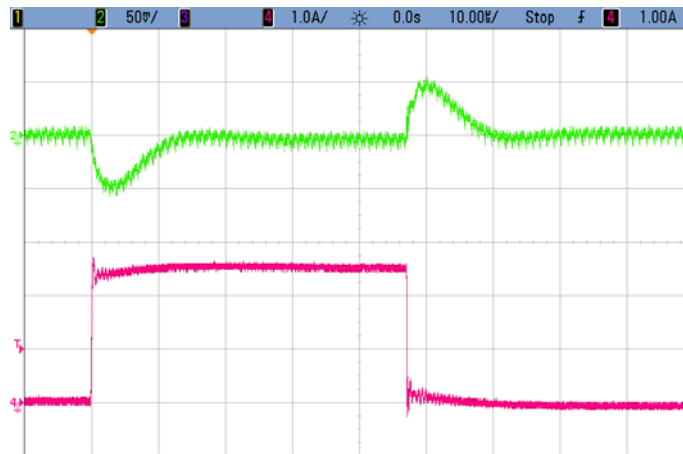

Figure 5. Load Step Response $V_{IN} = 12V$, $V_{OUT} = 1.8V$, 2.5A Load Step (0A-2.5A) Forced Continuous Mode $f_{SW} = 1MHz$ Trace 2: Output Voltage (50mV/DIV AC) Trace 4: Output Current (1A/DIV)

Load Step Response Waveforms

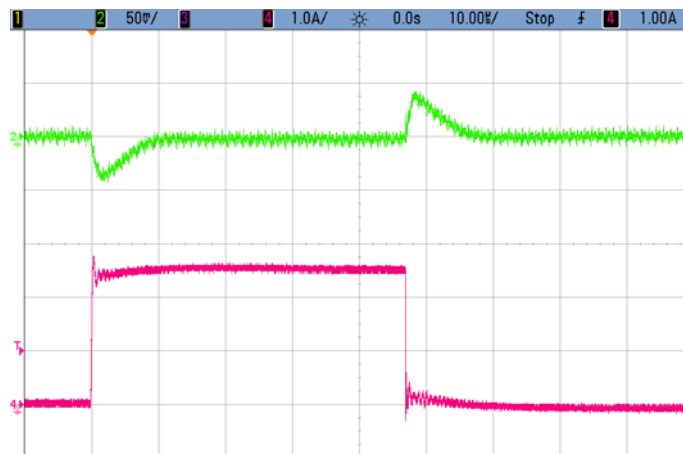

Figure 6. Load Step Response $V_{IN} = 12V$, $V_{OUT} = 3.3V$, 2.5A Load Step (0A-2.5A) Forced Continuous Mode $f_{SW} = 1MHz$ Trace 2: Output Voltage (50mV/DIV AC) Trace 4: Output Current (1A/DIV)

QUICK START PROCEDURE

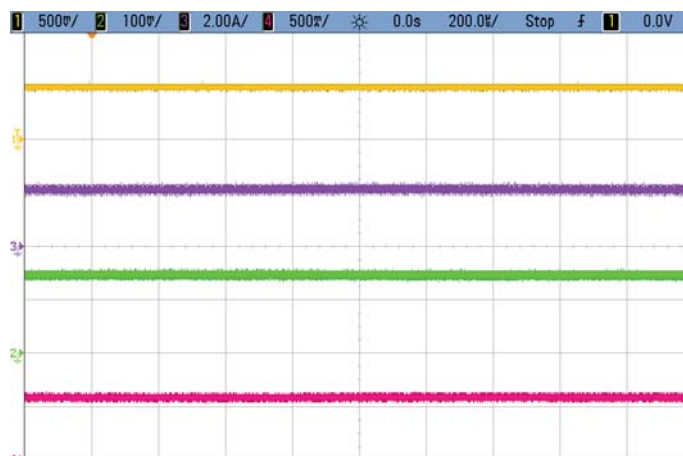

Figure 7. Input and Output Current Monitoring $V_{IN} = 12V$, $I_{IN} = 620mA$, $V_{OUT} = 3.3V$, $I_{OUT} = 2A$, $f_{SW} = 1MHz$
 Trace 1: I_{OUTMON} Voltage (0.5V/DIV) Trace 2: I_{INMON} Voltage (0.1V/DIV) Trace 3: I_{OUT} Current (2A/DIV)
 Trace 4: I_{IN} Current (500mA/DIV)

With a Current Sense Resistor of 4.02k Connected to Both The Input and Output Current Monitors, Their Voltages Equate to:

$$V_{I_{OUTMON}} = 2A/16000 \times 4.02k = 0.503V$$

$$V_{I_{INMON}} = 620mA/16000 \times 4.02k = 0.156V$$

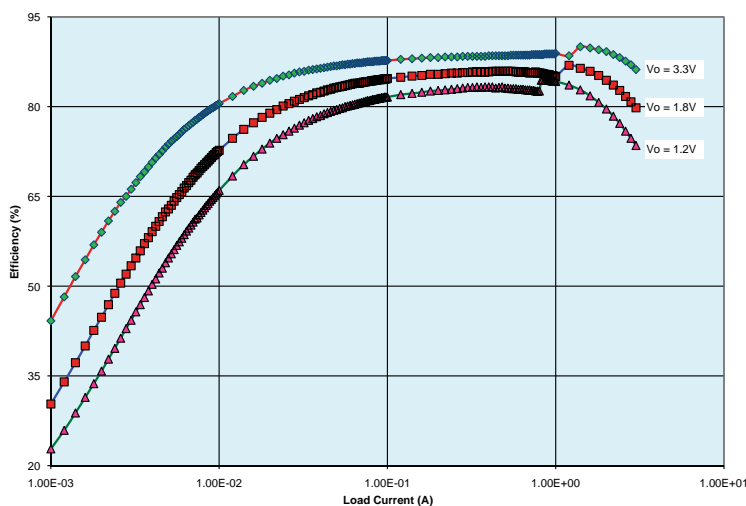

Figure 8. Efficiency Graph $V_{IN} = 12V$, Burst Mode, $f_{SW} = 1MHz$ L:1 μH Vishay IHLP-2020BZ-ER-1R0-M01

DEMO MANUAL DC1768A

PARTS LIST

ITEM	QTY	REFERENCE	PART DESCRIPTION	MANUFACTURER/PART NUMBER
Required Circuit Components				
1	1	C _{ITH}	Cap., NP0, 220pF, 25V, 10%, 0402	AVX, 04023A221KAT2A
2	1	C1	Cap., X5R, 2.2μF, 16V, 20%, 0603	TDK, C1608X5R1C225M
3	2	C3, C6	Cap., X7R, 22μF, 25V, 20%, 1210	MURATA, GRM32ER71E226M
4	1	C4	Cap., X5R, 47μF, 6.3V, 20%, 1206	Taiyo Yuden, JMK316BJ476ML-T
5	1	C5	Cap., NP0, 22pF, 50V, 10% 0402	AVX, 04025A220KAT
6	1	C8	Cap., X7R, 0.1μF, 25V, 10% 0603	TDK, C1608X7R1E104K
7	1	C11	Cap., X5R, 1μF, 6.3V, 10% 0402	AVX, 04026D105KAT2A
8	1	L1	Inductor, 1.0μH IHLP-2020BZ-01	Vishay IHLP-2020BZER1R0M01
9	1	R1TH	Res., Chip, 13k, 0.06W, 5% 0402	VISHAY, CRCW040213K0JNED
10	2	R3, R4	Res., Chip, 115k, 0.06W, 1% 0402	VISHAY, CRCW0402115KFKED
11	1	U1	IC. LTC3626EUDC, 3 × 4mm, 20 QFN	LINEAR TECH., LTC3626EUDC#PBF
Additional Demo Board Circuit Components				
12	0	CC(OPT)	Cap., 0402	
13	1	C2	Cap., Tant. 3.3μF, 35V, 20%, 6032	AVX, TAJW335M035R
14	0	C7, C10(OPT)	Cap., 1206	
15	1	C9	Cap., X7R, 2200pF, 25V, 20%, 0402	AVX, 04023C225MAT
16	2	C12, C13	Cap., X5R, 1μF, 25V, 10%, 0603	TDK, C1608X5R1E105K
17	0	C14(OPT)	Cap., 1812	
18	1	C15	Cap., X5R, 0.33μF, 25V, 20%, 0603	AVX, 06033D334MAT
19	0	D1(OPT)	Schottky Diode, SOD-323	
20	2	R10, R _{ON}	Res., Chip, 0Ω, 0.06W, 0402	VISHAY, CRCW04020000Z0ED
21	1	R1	Res., Chip, 100k, 0.06W, 5%, 0402	VISHAY, CRCW0402100KFKED
22	1	R2	Res., Chip, 324k, 0.06W, 1%, 0402	NIC, NRC04F3243TRF
23	1	R5	Res., Chip, 57.6k, 0.06W, 1%, 0402	VISHAY, CRCW040257K6FKED
24	1	R6	Res., Chip, 25.5k, 0.06W, 1%, 0402	VISHAY, CRCW040225K5FKED
25	0	R7, R9, R14(OPT)	Res., 0402	
26	2	R8, R11	Res., Chip, 1M, 0.06W, 5%, 0402	VISHAY, CRCW04021M00JNED
27	2	R12, R13	Res., Chip, 4.02k, 0.06W, 1%, 0402	VISHAY, CRCW04024K02FKED
28	1	R17	Res., Chip, 10Ω, 0.06W, 5%, 0402	VISHAY, CRCW040210R0JNED
Hardware: For Demo Board Only				
29	13	E1-E13	Turret, Testpoint	Mill Max2501-2-00-80-00-00-07-0
30	4	JP1, JP2, JP3, JP4	2 PIN 0.079 SINGLE ROW HEADER	SAMTEC, TMM102-02-L-S
31	1	JP5	2X2, 0.079 DOUBLE ROW HEADER	SAMTEC, TMM102-02-L-D
32	1	JP6	2X3, 0.079 DOUBLE ROW HEADER	SAMTEC, TMM103-02-L-D
33	7	JP7-JP13	3 PIN 0.079 SINGLE ROW HEADER	SAMTEC, TMM103-02-L-S
34	10	XJP1, XJP5-XJPP13	SHUNT, .079" CENTER	SAMTEC, 2SN-BK-G
35	4	MH1-MH4	STAND-OFF, NYLON 0.25"	KEYSTONE, 8831(SNAP ON)

SCHEMATIC DIAGRAM

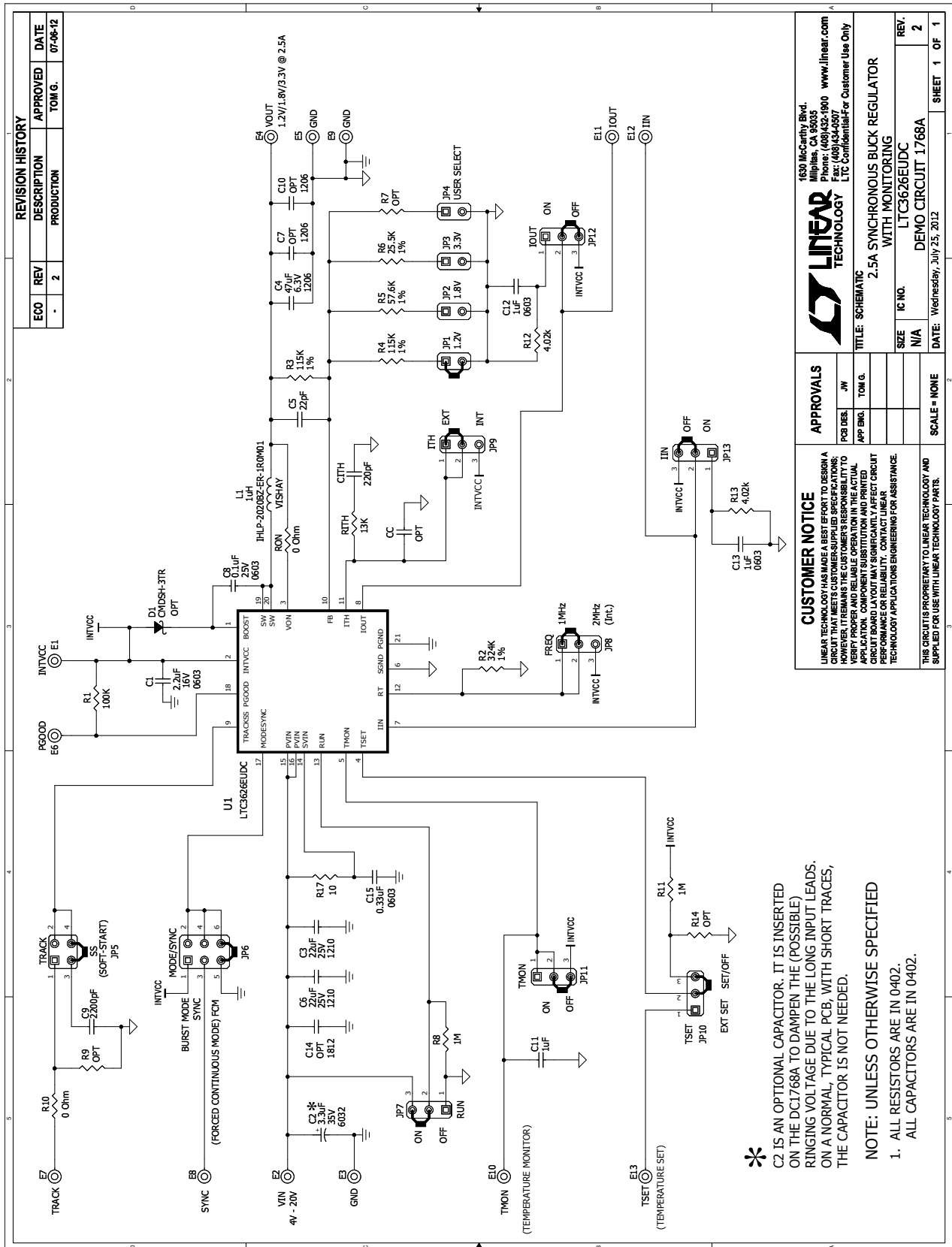

REVISION HISTORY		
ECO	REV	DATE
.	2	07-06-12
		APPROVED TOM G.
		PRODUCTION

1630 McCarty Blvd.
Milpitas, CA 95035
Phone: (408)432-1900 www.linear.com
Fax: (408)434-0507
LTC Confidential For Customer Use Only

LINEAR TECHNOLOGY

TITLE: SCHEMATIC
2.5A SYNCHRONOUS BUCK REGULATOR WITH MONITORING
LTC3626EUDC
DEMO CIRCUIT 1768A

REV. 2

IC NO. N/A

SIZE N/A

DATE: Wednesday, July 25, 2012

SHEET 1 OF 1

APPROVALS

PCB DES.	JW
APP ENG.	TOM G.

SCALE = NONE

CUSTOMER NOTICE
LINEAR TECHNOLOGY HAS MADE A BEST EFFORT TO DESIGN A CIRCUIT THAT MEETS CUSTOMER-SUPPLIED SPECIFICATIONS; HOWEVER, IT REMAINS THE CUSTOMER'S RESPONSIBILITY TO VERIFY PROPER AND RELIABLE OPERATION IN THE ACTUAL APPLICATION. LINEAR TECHNOLOGY DOES NOT WARRANT THAT THIS CIRCUIT BOARD LAYOUT MAY SIGNIFICANTLY AFFECT CIRCUIT PERFORMANCE OR RELIABILITY. CONTACT LINEAR TECHNOLOGY APPLICATIONS ENGINEERING FOR ASSISTANCE.

THIS CIRCUIT IS PROPRIETARY TO LINEAR TECHNOLOGY AND SUPPLIED FOR USE WITH LINEAR TECHNOLOGY PARTS.

* C2 IS AN OPTIONAL CAPACITOR. IT IS INSERTED ON THE DC1768A TO DAMPEN THE (POSSIBLE) RINGING VOLTAGE DUE TO THE LONG INPUT LEADS. ON A NORMAL, TYPICAL PCB, WITH SHORT TRACES, THE CAPACITOR IS NOT NEEDED.

NOTE: UNLESS OTHERWISE SPECIFIED
1. ALL RESISTORS ARE IN 0402.
2. ALL CAPACITORS ARE IN 0402.

DEMO MANUAL DC1768A

DEMONSTRATION BOARD IMPORTANT NOTICE

Linear Technology Corporation (LTC) provides the enclosed product(s) under the following **AS IS** conditions:

This demonstration board (DEMO BOARD) kit being sold or provided by Linear Technology is intended for use for **ENGINEERING DEVELOPMENT OR EVALUATION PURPOSES ONLY** and is not provided by LTC for commercial use. As such, the DEMO BOARD herein may not be complete in terms of required design-, marketing-, and/or manufacturing-related protective considerations, including but not limited to product safety measures typically found in finished commercial goods. As a prototype, this product does not fall within the scope of the European Union directive on electromagnetic compatibility and therefore may or may not meet the technical requirements of the directive, or other regulations.

If this evaluation kit does not meet the specifications recited in the DEMO BOARD manual the kit may be returned within 30 days from the date of delivery for a full refund. **THE FOREGOING WARRANTY IS THE EXCLUSIVE WARRANTY MADE BY THE SELLER TO BUYER AND IS IN LIEU OF ALL OTHER WARRANTIES, EXPRESSED, IMPLIED, OR STATUTORY, INCLUDING ANY WARRANTY OF MERCHANTABILITY OR FITNESS FOR ANY PARTICULAR PURPOSE. EXCEPT TO THE EXTENT OF THIS INDEMNITY, NEITHER PARTY SHALL BE LIABLE TO THE OTHER FOR ANY INDIRECT, SPECIAL, INCIDENTAL, OR CONSEQUENTIAL DAMAGES.**

The user assumes all responsibility and liability for proper and safe handling of the goods. Further, the user releases LTC from all claims arising from the handling or use of the goods. Due to the open construction of the product, it is the user's responsibility to take any and all appropriate precautions with regard to electrostatic discharge. Also be aware that the products herein may not be regulatory compliant or agency certified (FCC, UL, CE, etc.).

No License is granted under any patent right or other intellectual property whatsoever. **LTC assumes no liability for applications assistance, customer product design, software performance, or infringement of patents or any other intellectual property rights of any kind.**

LTC currently services a variety of customers for products around the world, and therefore this transaction **is not exclusive**.

Please read the DEMO BOARD manual prior to handling the product. Persons handling this product must have electronics training and observe good laboratory practice standards. **Common sense is encouraged.**

This notice contains important safety information about temperatures and voltages. For further safety concerns, please contact a LTC application engineer.

Mailing Address:

Linear Technology
1630 McCarthy Blvd.
Milpitas, CA 95035

Copyright © 2004, Linear Technology Corporation