



# IR Emitter and Detector Product Data Sheet

LTE-3223L-062A

Spec No.: DS50-2013-0078

Effective Date: 11/01/2013

Revision: -

**LITE-ON DCC**

**RELEASE**

BNS-OD-FC001/A4



REV.A OCT 2013

## FEATURES

- \* SPECIAL FOR HIGH CURRENT AND LOW FORWARD VOLTAGE
- \* HIGH POWER
- \* AVAILABLE FOR PULSE OPERATING
- \* WIDE VIEWING ANGLE
- \* CLEAR TRANSPARENT COLOR PACKAGE

## PACKAGE DIMENSIONS

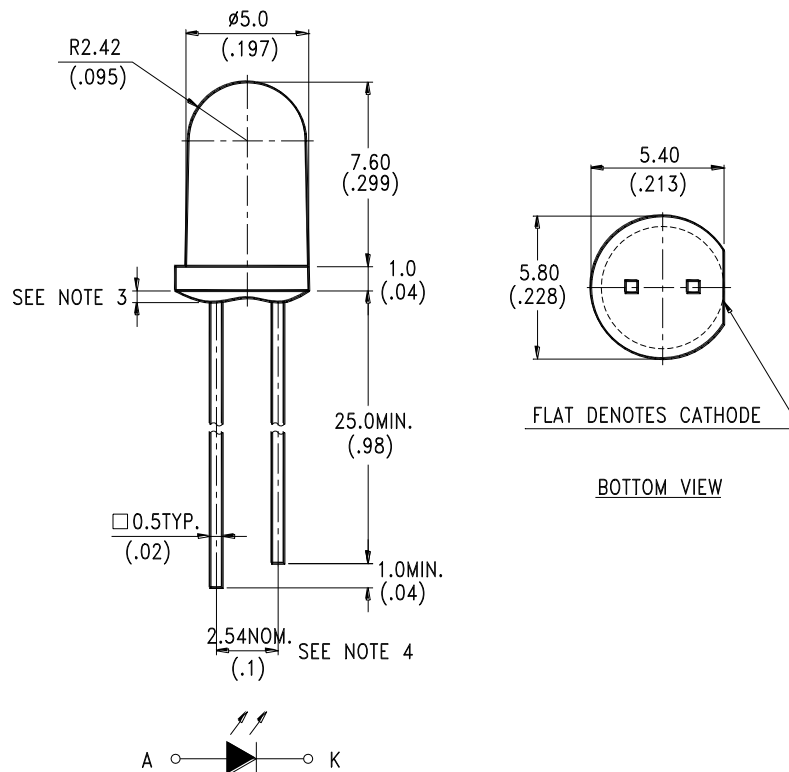

### NOTES:

1. All dimensions are in millimeters (inches).
2. Tolerance is  $\pm 0.25\text{mm}$  (.010") unless otherwise noted.
3. Protruded resin under flange is 1.5mm (.059") max.
4. Lead spacing is measured where the leads emerge from the package.
5. Specifications are subject to change without notice.
6. The anode and cathode pin length shown in drawing is a reference. The dimension after taping will be adopted (shown in page 4).
7. Manufacturing Location: Liteon ChangZhou and Thailand



# LITE-ON ELECTRONICS, INC.

Property of Lite-On Only

## ABSOLUTE MAXIMUM RATINGS AT TA=25°C

PARAMETER	MAXIMUM RATING	UNIT
Power Dissipation	150	mW
Peak Forward Current (300pps, 10μs pulse)	2	A
Continuous Forward Current	100	mA
Reverse Voltage	5	V
Operating Temperature Range	-40°C to + 85°C	
Storage Temperature Range	-55°C to + 100°C	
Lead Soldering Temperature[1.6mm(.063") From Body]	260°C for 5 Seconds	

## ELECTRICAL OPTICAL CHARACTERISTICS AT TA=25°C

PARAMETER	SYMBOL	MIN.	TYP.	MAX.	UNIT	TEST CONDITION
Radiant Intensity	$I_E$	8.0	15.0		mW/sr	$I_F = 20\text{mA}$
Peak Emission Wavelength	$\lambda_{\text{Peak}}$		940		nm	$I_F = 20\text{mA}$
Spectral Line Half-Width	$\Delta\lambda$		50		nm	$I_F = 20\text{mA}$
Forward Voltage	$V_F$		1.25	1.6	V	$I_F = 50\text{mA}$
Forward Voltage	$V_F$		1.65	2.1	V	$I_F = 250\text{mA}$
Reverse Current	$I_R$			100	μA	$V_R = 5\text{V}$
Viewing Angle (See FIG.6)	$2\theta_{1/2}$		30		deg.	

## TYPICAL ELECTRICAL / OPTICAL CHARACTERISTICS CURVES

(25°C Ambient Temperature Unless Otherwise Noted)

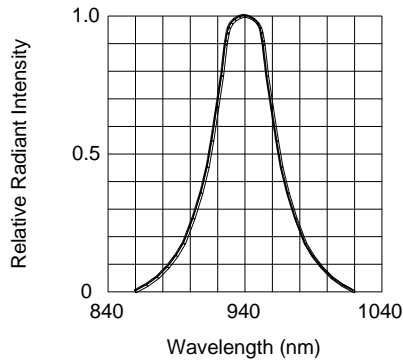

FIG.1 SPECTRAL DISTRIBUTION

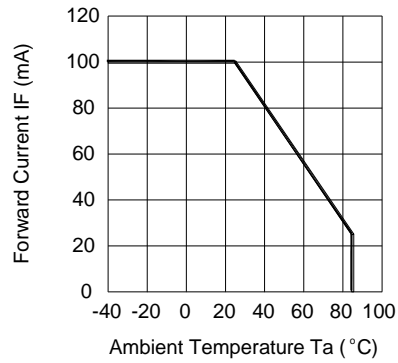

FIG.2 FORWARD CURRENT VS. AMBIENT TEMPERATURE

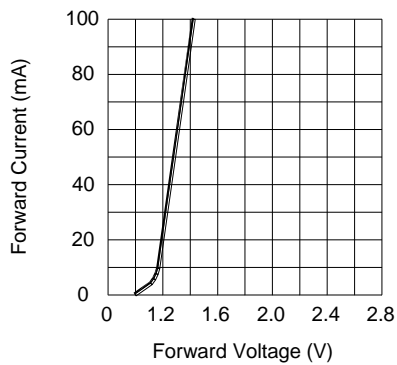

FIG.3 FORWARD CURRENT VS. FORWARD VOLTAGE

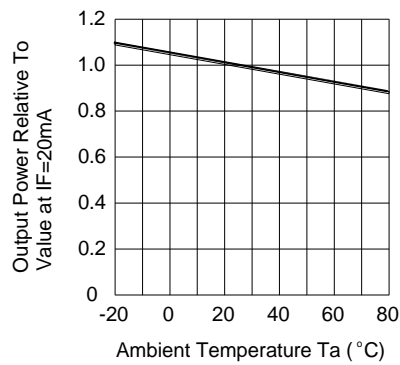

FIG.4 RELATIVE RADIANT INTENSITY VS. AMBIENT TEMPERATURE

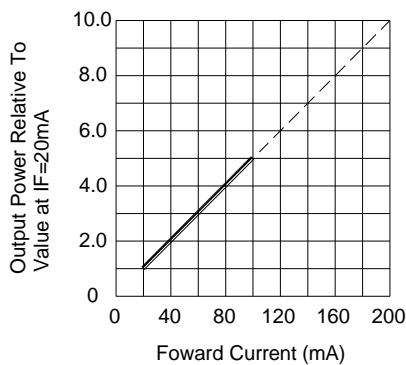

FIG.5 RELATIVE RADIANT INTENSITY VS. FORWARD CURRENT

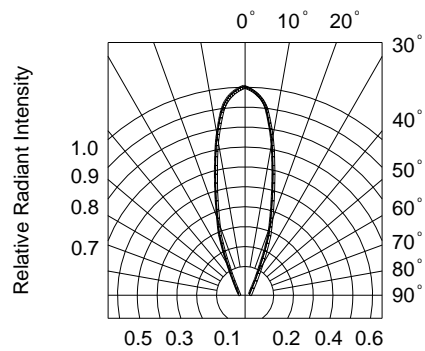
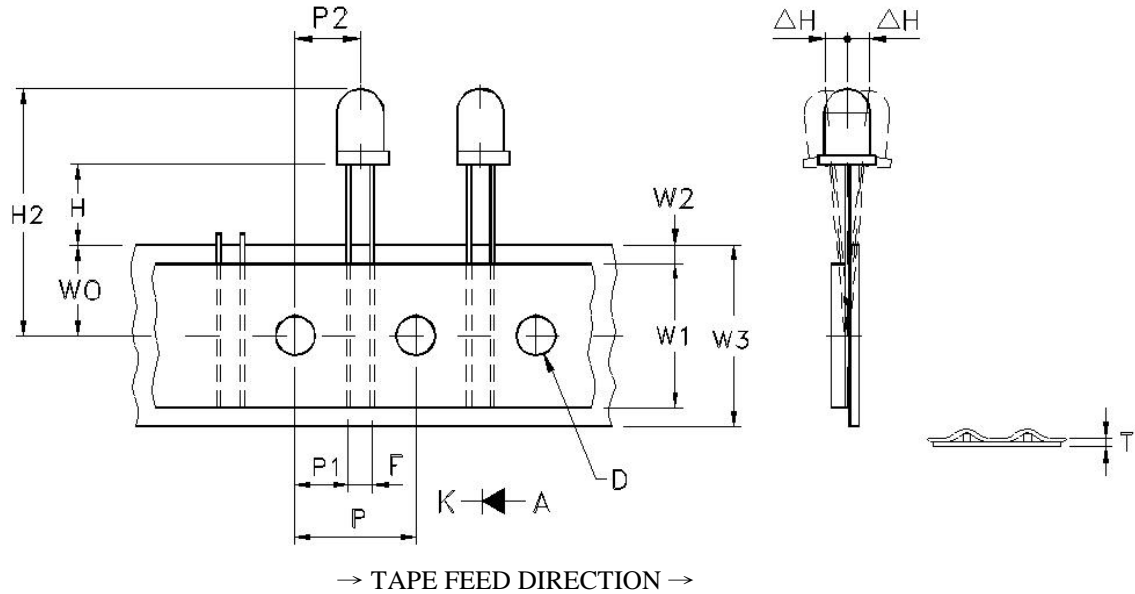

FIG.6 RADIATION DIAGRAM

## PACKAGE DIMENSIONS



I T E M	SYMBOL	SPECIFICATION			
		MINIMUM		MAXIMUM	
		MM	INCH	MM	INCH
Tape Feed Hole Diameter	D	3.8	0.149	4.2	0.165
Component Lead Pitch	F	2.3	0.091	3.0	0.118
Front To Rear Deflection	$\Delta H$	--	--	2.0	0.078
Feed Hole To Bottom Of Component	H	17.0	0.669	18.0	0.709
Feed Hole To Overall Component Height	H2	--	--	38.4	1.512
Feed Hole Pitch	P	12.4	0.488	13.0	0.511
Lead Location	P1	4.4	0.173	5.8	0.228
Center Of Component Location	P2	5.05	0.198	7.65	0.301
Total Tape Thickness	T	--	--	0.90	0.035
Feed Hole Location	W0	8.5	0.334	9.5	0.374
Adhesive Tape Width	W1	12.5	0.492	13.5	0.531
Adhesive Tape Position	W2	0	0	3.0	0.118
Tape Width	W3	17.5	0.689	19.0	0.748

## PACKING

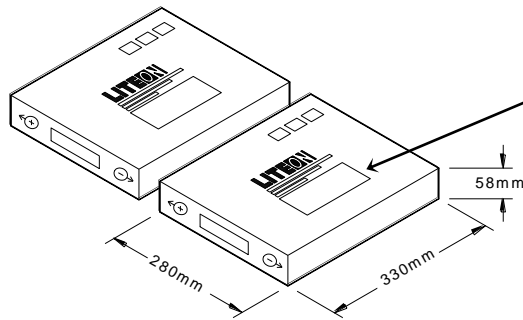

顧客(CUSTOMER): \_\_\_\_\_  
 型別(DIVICE TYPE): LTE-3223L-062A  
 數量(QUANTITY): 2000  
 品管簽章(Q.C.STAMP): \_\_\_\_\_

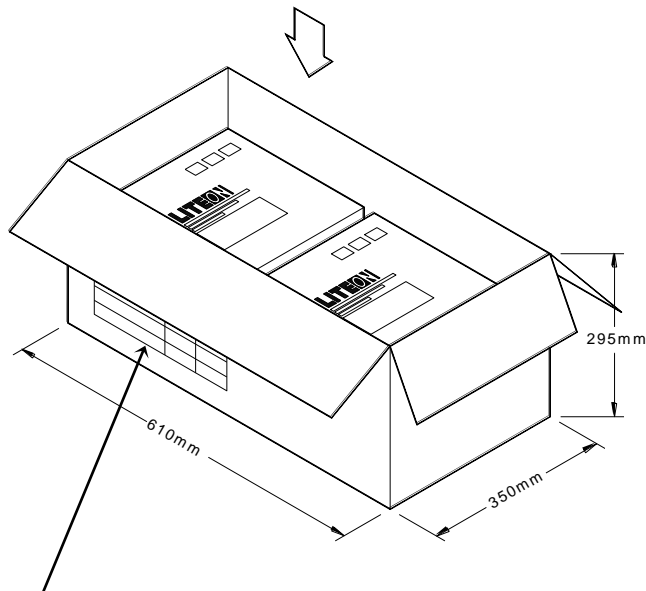

DIVICE NO.	BIN	QUANTITY
LTE-3223L-062A		20K
Q.C STAMP		