



Micro Commercial Components  
 21201 Itasca Street Chatsworth  
 CA 91311  
 Phone: (818) 701-4933  
 Fax: (818) 701-4939

# FS2A THRU FS2M

## Features

- Superfast Recovery Times For High Efficiency
- For Surface Mount Application
- Higher Temp Soldering: 250°C for 10 Seconds At Terminals
- Available on Tape and Reel

## Maximum Ratings

- Operating Temperature: -50°C to +150°C
- Storage Temperature: -50°C to +150°C

MCC Catalog Number	Device Marking	Maximum Recurrent Peak Reverse Voltage	Maximum RMS Voltage	Maximum DC Blocking Voltage
FS2A	FS2A	50V	35V	50V
FS2B	FS2B	100V	70V	100V
FS2D	FS2D	200V	140V	200V
FS2G	FS2G	400V	280V	400V
FS2J	FS2J	600V	420V	600V
FS2K	FS2K	800V	560V	800V
FS2M	FS2M	1000V	700V	1000V

Electrical Characteristics @ 25°C Unless Otherwise Specified

Average Forward Current	$I_{F(AV)}$	2.0A	$T_J=90^\circ\text{C}$
Peak Forward Surge Current	$I_{FSM}$	50A	8.3ms half sine
Maximum Instantaneous Forward Voltage	$V_F$	1.30V	$I_{FM}=2.0A$ $T_A=25^\circ\text{C}$
Maximum DC Reverse Current At Rated DC Blocking Voltage	$I_R$	5.0uA	$T_J=25^\circ\text{C}$
Maximum Reverse Recovery Times FR2A-2G FR2J FR2K-2M	$t_{rr}$	150ns 250ns 500ns	$I_F=0.5A$ , $I_R=1.0A$ , $I_{rr}=0.25A$
Typical Junction Capacitance	$C_j$	50pF	Measured at 1.0MHz, $V_R=4.0V$

Pulse test: Pulse width 300 usec, duty cycle 2%.

## 2.0 Amp Fast Recovery Rectifier 50 to 1000 Volts

### DO-214AC (SMAJ) (High Profile)

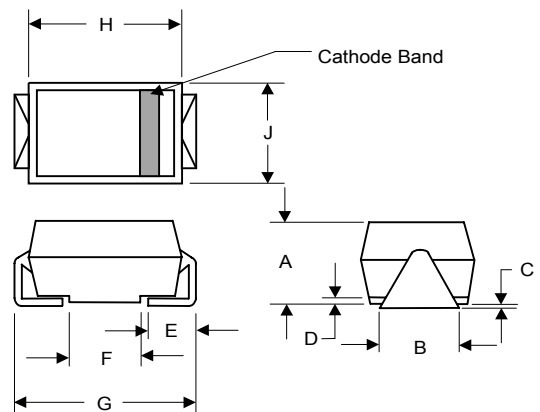

DIM	INCHES		MM		NOTE
	MIN	MAX	MIN	MAX	
A	.078	.116	1.98	2.95	
B	.067	.089	1.70	2.25	
C	.002	.008	.05	.20	
D	---	.02	---	.51	
E	.035	.055	.89	1.40	
F	.065	.096	1.65	2.45	
G	.205	.224	5.21	5.69	
H	.160	.180	4.06	4.57	
J	.100	.112	2.57	2.84	

#### SUGGESTED SOLDER PAD LAYOUT

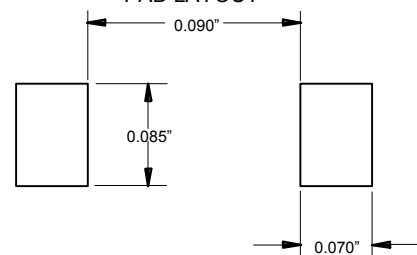

# FS2A thru FS2M

Figure 1  
Typical Forward Characteristics

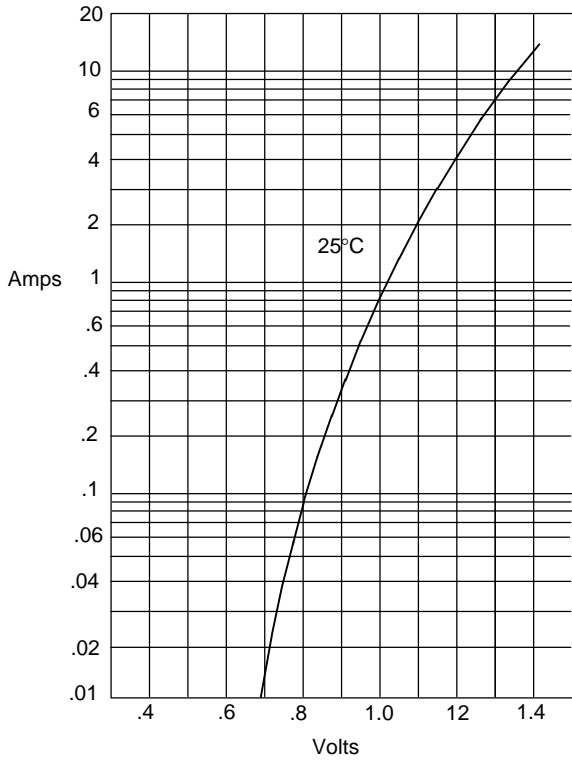

Instantaneous Forward Current - Amperes *versus*  
Instantaneous Forward Voltage - Volts

Figure 2  
Forward Derating Curve

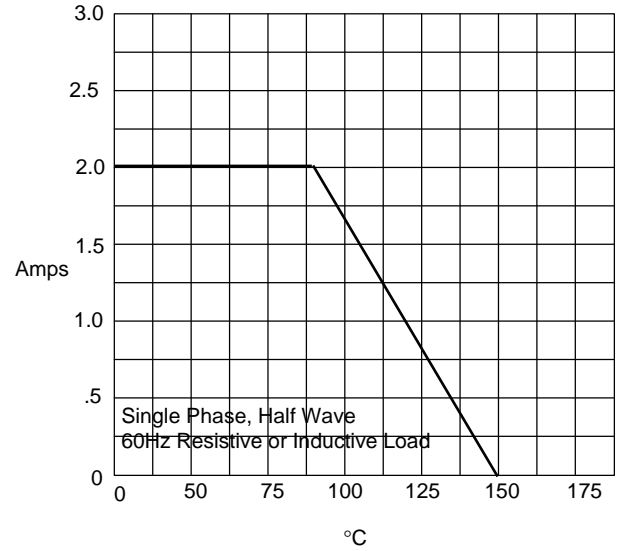

Average Forward Rectified Current - Amperes *versus*  
Ambient Temperature - °C

Figure 3  
Junction Capacitance

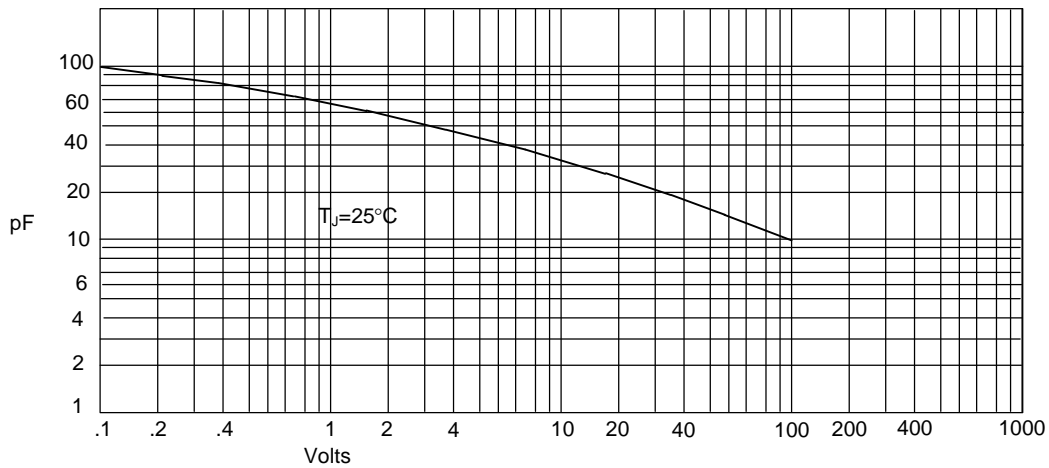

Junction Capacitance - pF *versus*  
Reverse Voltage - Volts

# FS2A thru FS2M

Figure 4  
Maximum Non-Repetitive Forward Surge Current

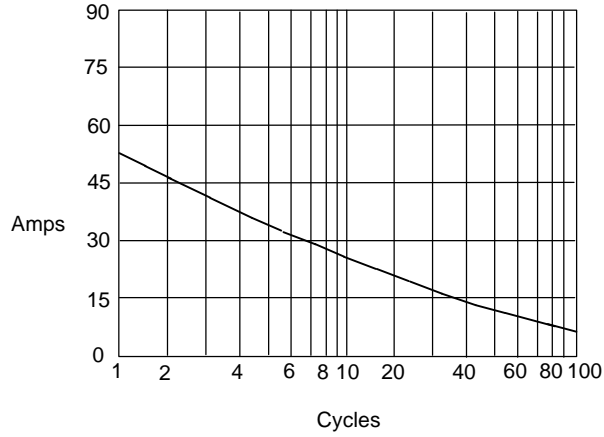

Peak Forward Surge Current - Amperes versus  
Number Of Cycles At 60Hz - Cycles

Figure 5  
Reverse Recovery Time Characteristic And Test Circuit Diagram

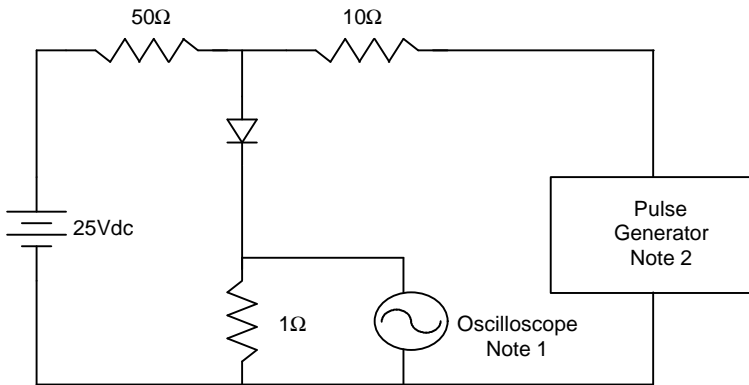

- Notes:
1. Rise Time = 7ns max.  
Input impedance = 1 megohm, 22pF
  2. Rise Time = 10ns max.  
Source impedance = 50 ohms
  3. Resistors are non-inductive

