

### Compact IPM Series Dual Module 400 Amperes/600 Volts

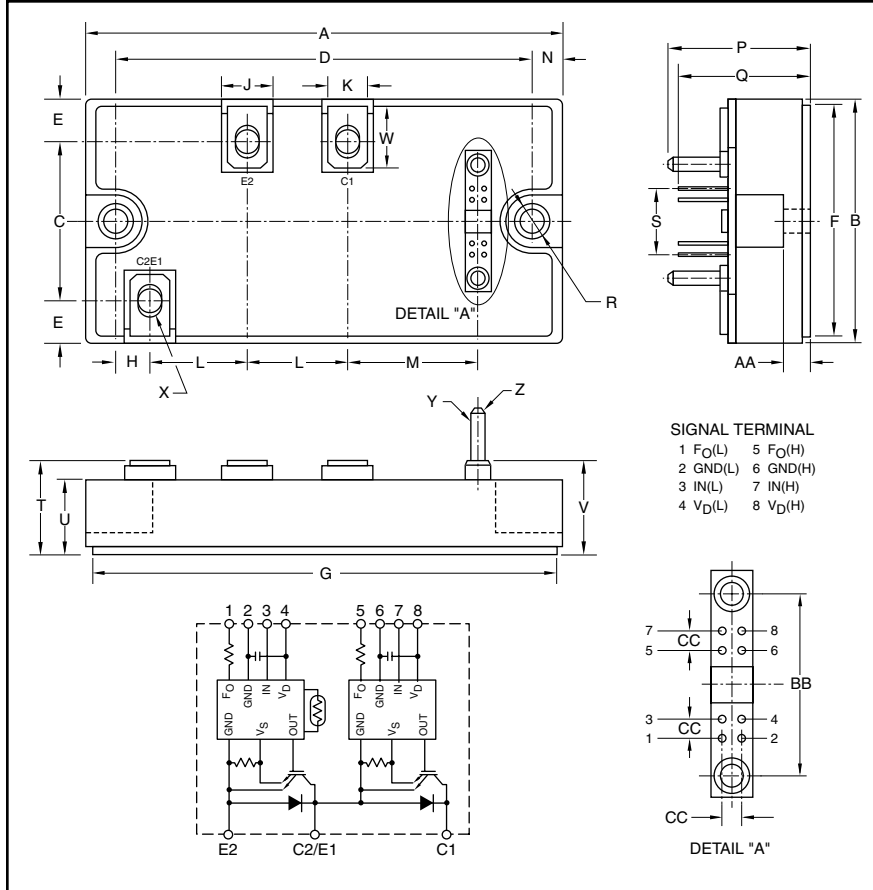

#### Description:

Powerex Dual Compact IPM Series Modules are designed for use in switching applications. Each module consists of two IGBT Transistors in a half-bridge configuration, with each transistor having a reverse-connected super-fast recovery free-wheel diode. All components and interconnects are isolated from the heat sinking baseplate, offering simplified system assembly and thermal management.

#### Features:

- Over-Current and Over-Temperature Protection
- Low V<sub>CE(sat)</sub>
- Isolated Baseplate for Easy Heat Sinking

#### Applications:

- AC Motor Control
- Motion/Servo Control
- UPS
- Welding Power Supplies
- Laser Power Supplies

#### Ordering Information:

MIG400J2CSB1W is a 600V (V<sub>CE(s)</sub>), 400 Ampere Compact IPM Series Dual Module.

#### Outline Drawing and Circuit Diagram

Dimensions	Inches	Millimeters
A	4.21±0.04	107.0±1.0
B	2.16±0.04	55.0±1.0
C	1.42±0.03	36.0±0.8
D	3.66±0.01	93.0±0.3
E	0.37±0.03	9.5±0.8
F	2.05±0.02	52.0±0.5
G	4.09±0.02	104.0±0.5
H	0.29±0.03	7.5±0.8
J	0.47	12.0
K	0.35	9.0
L	0.87±0.03	22.0±0.8
M	1.15±0.03	29.24±0.8
N	0.28	7.0
P	1.32+0.04/-0.02	33.5+1.0/-0.5

Dimensions	Inches	Millimeters
Q	1.24±0.03	31.5±0.8
R	0.22 Dia.	5.5 Dia.
S	0.6	15.24
T	0.87+0.04/-0.01	22.0+1.0/-0.3
U	0.73±0.03	18.5±0.8
V	0.89+0.04/-0.024	22.0+1.0/-0.6
W	0.55	13.9
X	M5 Metric	M5
Y	0.12 Dia.	3.0 Dia.
Z	0.025 Sq.	0.64 Sq.
AA	0.28	7.0
BB	1.0±0.024	25.4±0.6
CC	0.1	2.54



Powerex, Inc., 200 E. Hillis Street, Youngwood, Pennsylvania 15697-1800 (724) 925-7272

**MIG400J2CSB1W**  
**Compact IPM Series Dual Module**  
400 Amperes/600 Volts

**Absolute Maximum Ratings,  $T_j = 25^\circ\text{C}$  unless otherwise specified**

Characteristics	Symbol	MIG400J2CSB1W	Units
Power Device Junction Temperature	$T_j$	-20 to 150	$^\circ\text{C}$
Storage Temperature	$T_{\text{stg}}$	-40 to 125	$^\circ\text{C}$
Operating Temperature	$T_C$	-20 to 100	$^\circ\text{C}$
Mounting Torque, M5 Mounting Screws	—	31	in-lb
Module Weight (Typical)	—	278	Grams
Isolation Voltage, AC 1 minute, 60Hz Sinusoidal	$V_{\text{ISO}}$	2500	Volts

**IGBT Inverter Sector**

Supply Voltage (P-N Power Terminal)	$V_{\text{CC}}$	450	Volts
Collector-Emitter Voltage	$V_{\text{CES}}$	600	Volts
Collector Current ( $T_C = 25^\circ\text{C}$ , DC)	$I_C$	400	Amperes
Forward Current ( $T_C = 25^\circ\text{C}$ , DC)	$I_F$	400	Amperes
Collector Power Dissipation ( $T_C = 25^\circ\text{C}$ )	$P_C$	2190	Watts

**IGBT Control Sector**

Control Supply Voltage ( $V_D$ -GND Terminal)	$V_D$	20	Volts
Input Voltage (IN-GND Terminal)	$V_{\text{IN}}$	20	Volts
Fault Output Voltage ( $F_O$ -GND (L) Terminal)	$V_{\text{FO}}$	20	Volts
Fault Output Current ( $F_O$ Sink Current)	$I_{\text{FO}}$	10	mA



Powerex, Inc., 200 E. Hillis Street, Youngwood, Pennsylvania 15697-1800 (724) 925-7272

**MIG400J2CSB1W**  
**Compact IPM Series Dual Module**  
 400 Amperes/600 Volts

**Electrical and Mechanical Characteristics,  $T_j = 25^\circ\text{C}$  unless otherwise specified**

Characteristics	Symbol	Test Conditions	Min.	Typ.	Max.	Units
<b>IGBT Inverter Sector</b>						
Collector Cut-off Current	$I_{CEX}$	$V_{CE} = 600\text{V}, T_j = 25^\circ\text{C}$	—	—	1	mA
		$V_{CE} = 600\text{V}, T_j = 125^\circ\text{C}$	—	—	10	mA
Collector-Emitter Saturation Voltage	$V_{CE(sat)}$	$V_D = 15\text{V}, I_C = 400\text{A}, V_{IN} = 15\text{V to } 0\text{V}, T_j = 25^\circ\text{C}$	1.6	1.9	2.3	Volts
Saturation Voltage		$V_D = 15\text{V}, I_C = 400\text{A}, V_{IN} = 15\text{V to } 0\text{V}, T_j = 125^\circ\text{C}$	—	2.1	—	Volts
Forward Voltage	$V_F$	$I_F = 400\text{A}, T_j = 25^\circ\text{C}$	—	2.3	2.7	Volts
Switching Time	$t_{on}$		—	2.0	3.0	$\mu\text{s}$
	$t_{c(on)}$	$V_{CC} = 300\text{V}, I_C = 400\text{A},$	—	0.4	—	$\mu\text{s}$
	$t_{rr}$	$V_D = 15\text{V}, V_{IN} = 15\text{V} \leftrightarrow 0\text{V},$	—	0.2	—	$\mu\text{s}$
	$t_{off}$	$T_j = 25^\circ\text{C}, \text{ Inductive Load}$	—	1.5	2.5	$\mu\text{s}$
	$t_{c(off)}$		—	0.25	—	$\mu\text{s}$
<b>Control Sector</b>						
Control Circuit Current	$I_{D(H)}$	High Side, $V_D = 15\text{V}$	—	13	17	mA
	$I_{D(L)}$	Low Side, $V_D = 15\text{V}$	—	13	17	mA
Input-ON Signal Voltage	$V_{IN(on)}$	$V_D = 15\text{V}$	1.4	1.6	1.8	Volts
Input-OFF Signal Voltage	$V_{IN(off)}$	$V_D = 15\text{V}$	2.2	2.5	2.8	Volts
Fault Output Current	$I_{FO(on)}$	Protection Current, $V_D = 15\text{V}$	—	10	12	mA
	$I_{FO(off)}$	Normal Current, $V_D = 15\text{V}$	—	—	0.1	mA
Over-Current Protection Trip Level	$O_C$	$V_D = 15\text{V}, T_j \leq 125^\circ\text{C}$	640	—	—	Amperes
Short-Circuit Current	$S_C$	$V_D = 15\text{V}, T_j \leq 125^\circ\text{C}$	640	—	—	Amperes
Protection Trip Level						
Over-Current Cut-off Time	$t_{off(OC)}$	—	—	5	—	$\mu\text{s}$
Over-Temperature	$O_T$	Trip Level Case Temperature	110	118	125	$^\circ\text{C}$
Protection	$O_{Tr}$	Reset Level Case Temperature	—	98	—	$^\circ\text{C}$
Control Supply Under Voltage Protection	$U_V$	Trip Level	11.0	12.0	12.5	Volts
	$U_{Vr}$	Reset Level	12.0	12.5	13.0	Volts
Fault Output Pulse Width	$t_d(FO)$	$V_D = 15\text{V}$	1	2	3	ms



Powerex, Inc., 200 E. Hillis Street, Youngwood, Pennsylvania 15697-1800 (724) 925-7272

**MIG400J2CSB1W**  
**Compact IPM Series Dual Module**  
400 Amperes/600 Volts

### Thermal Characteristics

Characteristic	Symbol	Condition	Min.	Typ.	Max.	Units
Junction to Case	$R_{th(j-c)Q}$	IGBT (Per 1/2 Module)	—	—	0.057	°C/Watt
Thermal Resistance	$R_{th(j-c)D}$	FWDi (Per 1/2 Module)	—	—	0.130	°C/Watt
Contact Thermal Resistance	$R_{th(c-f)}$	—	—	0.017	—	°C/Watt

### Recommended Conditions for Use

Characteristic	Symbol	Condition	Min.	Typ.	Max.	Units
Supply Voltage	$V_{CC}$	P-N Power Terminals	—	300	400	Volts
Control Supply Voltage	$V_D$	$V_D$ -GND Signal terminal	13.5	15	16.5	Volts
Switching Frequency	$f_C$	PMW Control	—	—	20	kHz
Dead Time*	$t_{DEAD}$	—	5	—	—	$\mu s$

\*The table lists Dead Time requirements for the module input, excluding photocoupler delays. When specifying Dead Time requirements for the photocoupler input, please add photocoupler delays to the Dead Time given above.



Powerex, Inc., 200 E. Hillis Street, Youngwood, Pennsylvania 15697-1800 (724) 925-7272

**MIG400J2CSB1W**  
**Compact IPM Series Dual Module**  
 400 Amperes/600 Volts

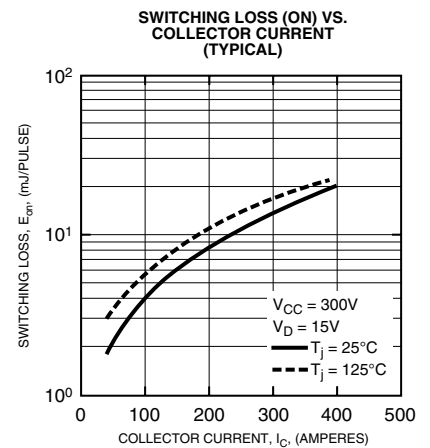
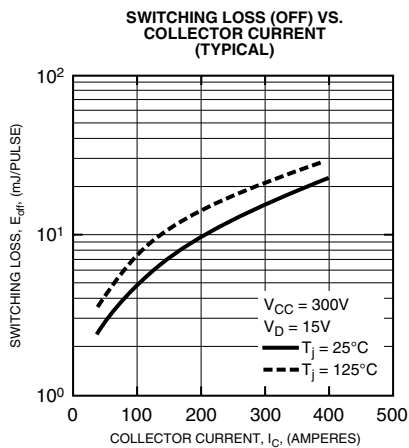
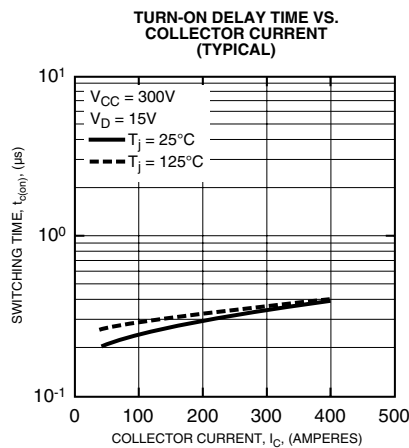
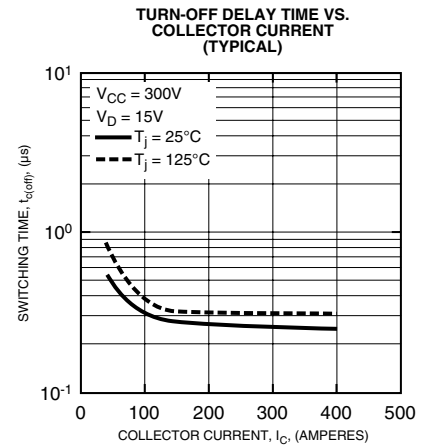
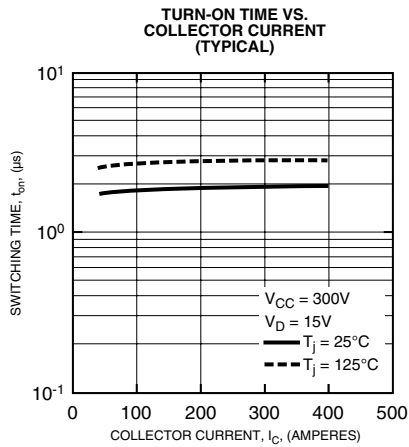
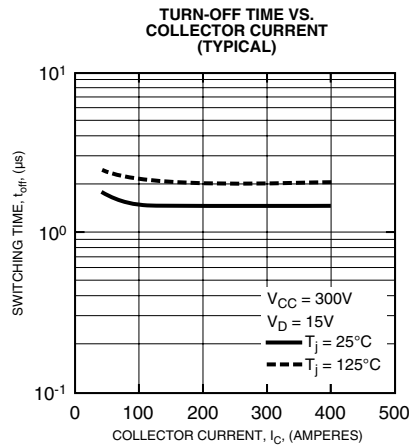
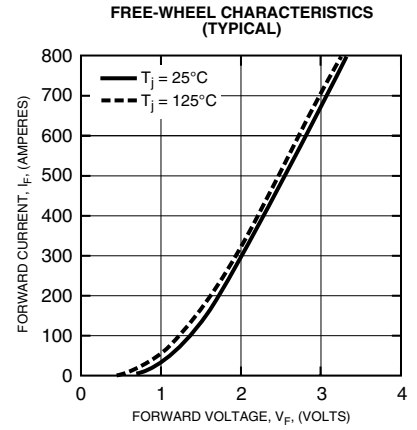
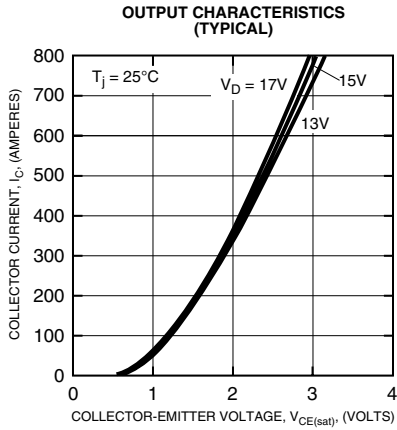
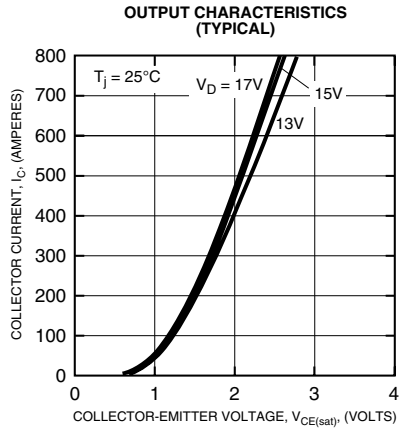



Powerex, Inc., 200 E. Hillis Street, Youngwood, Pennsylvania 15697-1800 (724) 925-7272

**MIG400J2CSB1W**  
**Compact IPM Series Dual Module**  
 400 Amperes/600 Volts

