

Silicon NPN Power Transistors

2SC3853

DESCRIPTION

- With TO-3PN package
- Complement to type 2SA1489

APPLICATIONS

- Audio and general purpose

PINNING

PIN	DESCRIPTION
1	Base
2	Collector;connected to mounting base
3	Emitter

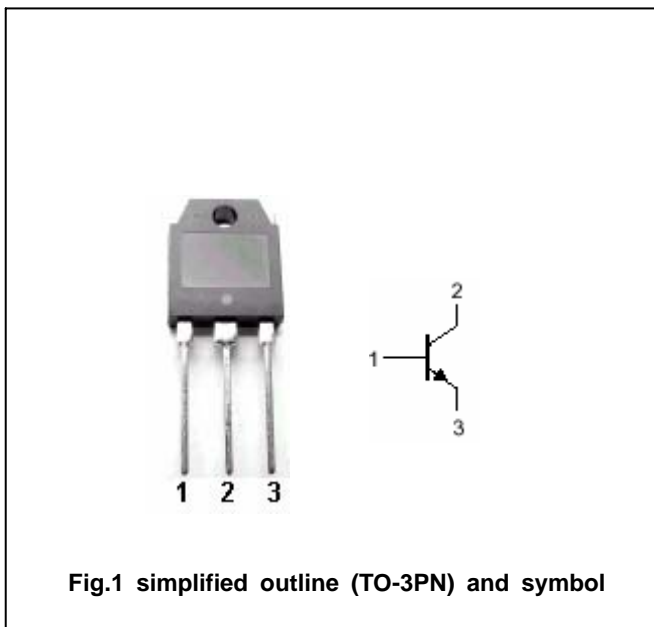

Fig.1 simplified outline (TO-3PN) and symbol

Absolute maximum ratings(Ta=)

SYMBOL	PARAMETER	CONDITIONS	VALUE	UNIT
V _{CBO}	Collector-base voltage	Open emitter	120	V
V _{CEO}	Collector-emitter voltage	Open base	80	V
V _{EBO}	Emitter-base voltage	Open collector	6	V
I _C	Collector current		6	A
P _C	Collector power dissipation	T _C =25	60	W
T _j	Junction temperature		150	
T _{stg}	Storage temperature		-55~150	

Silicon NPN Power Transistors

2SC3853

CHARACTERISTICS

T_j=25 unless otherwise specified

SYMBOL	PARAMETER	CONDITIONS	MIN	TYP.	MAX	UNIT
V _{(BR)CEO}	Collector-emitter breakdown voltage	I _C =50mA ; I _B =0	80			V
V _{(BR)EBO}	Emitter-base breakdown voltage	I _E =1mA ; I _C =0	6			V
V _{CEsat}	Collector-emitter saturation voltage	I _C =2A ; I _B =0.2A			1.5	V
I _{CBO}	Collector cut-off current	V _{CB} =120V ; I _E =0			100	μ A
I _{EBO}	Emitter cut-off current	V _{EB} =6V ; I _C =0			100	μ A
h _{FE}	DC current gain	I _C =2A ; V _{CE} =4V	50			
f _T	Transition frequency	I _C =0.5A ; V _{CE} =12V		20		MHz

Silicon NPN Power Transistors

2SC3853

PACKAGE OUTLINE

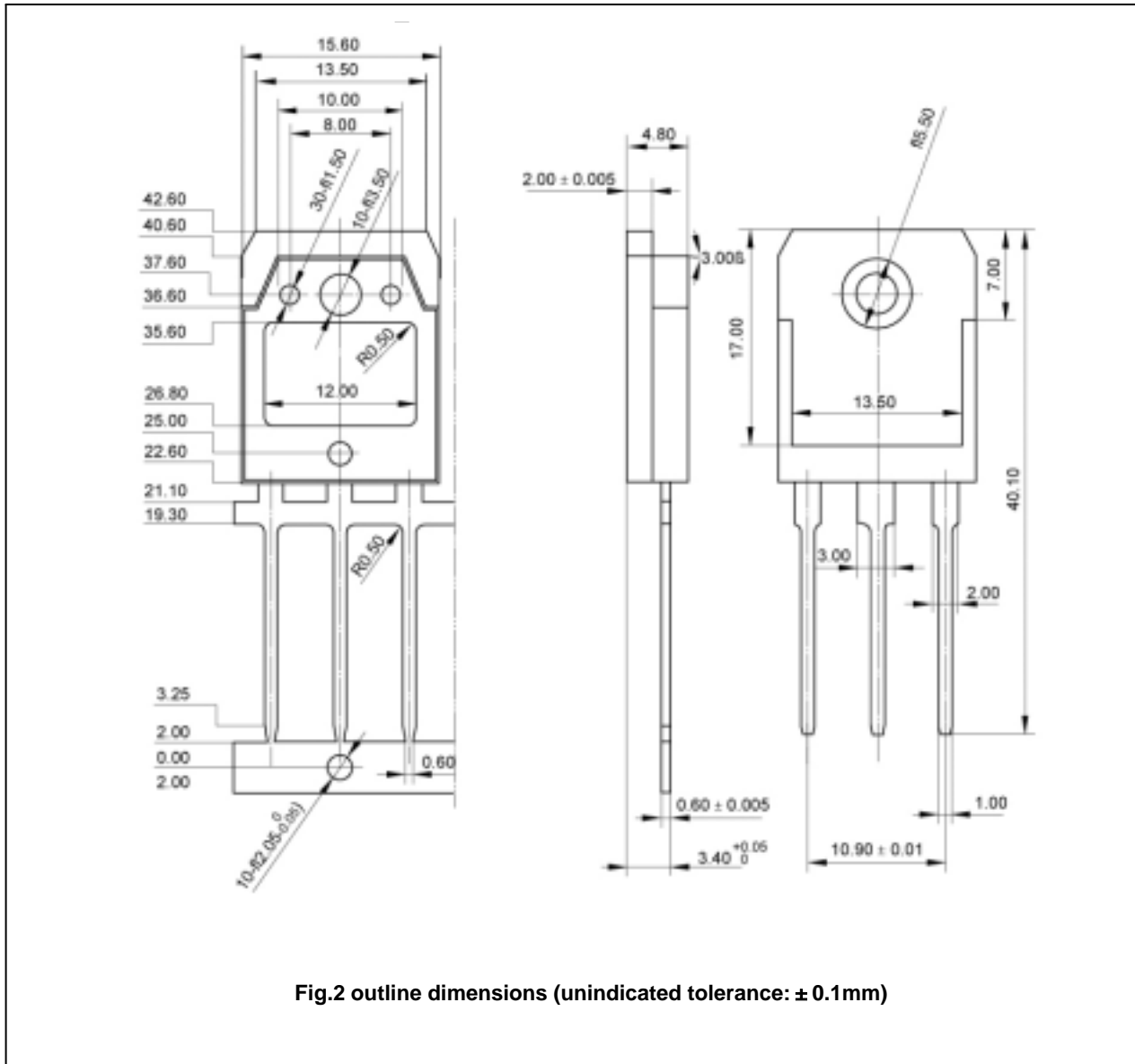

Fig.2 outline dimensions (unindicated tolerance: ± 0.1 mm)