



Datasheet - MAP3222

Dual Channel High Brightness LED Driver

MAP3222 – Dual Channel High Brightness LED Driver

General Description

MAP3222 is high efficiency dual channel boost type PWM driver in single package. It is designed for high brightness LED driver optimized for backlighting system for large size LCD module.

MAP3222 offers the function of accurate and fast LED dimming control using PWM interface and external dimming MOSFET.

MAP3222 has the over-voltage protection, UVLO, LED short current and Boost switch current limit protection.

MAP3222 is available in SOIC-20 Pin package with Halogen-free (fully RoHS compliant).

For more information, please contact local MagnaChip sales office in world-wide or visit MagnaChip's website at www.magnachip.com.

Features

- Dual output into single package
- Wide input voltage range up to 20V
- PWM Dimming
- Current Mode Control Type
- Auto Restart Mode Protection
- Programmable Output Over Voltage Protection
- Programmable LED Short current Protection
- Boost switch current limit protection
- Power Good
- Package : SOIC-20 Pin

Applications

- High Brightness white LED backlighting for LCD TVs and monitors
- General LED lighting applications

Ordering Information

Part Number	Top Marking	Ambient Temperature Range	Package	RoHS Status
MAP3222SIRH	MAP3222	-40°C to +85°C	SOIC-20 Pin	Halogen Free

Typical Application

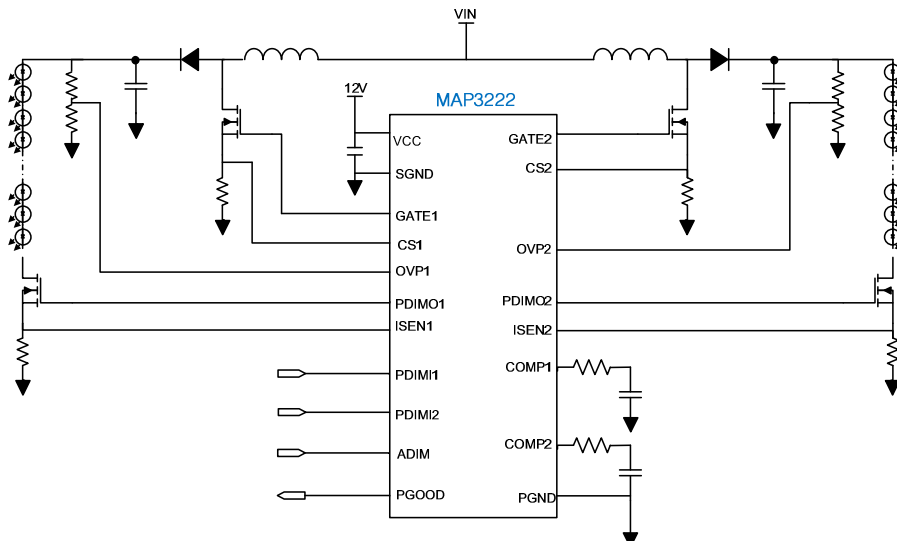

Pin Configuration

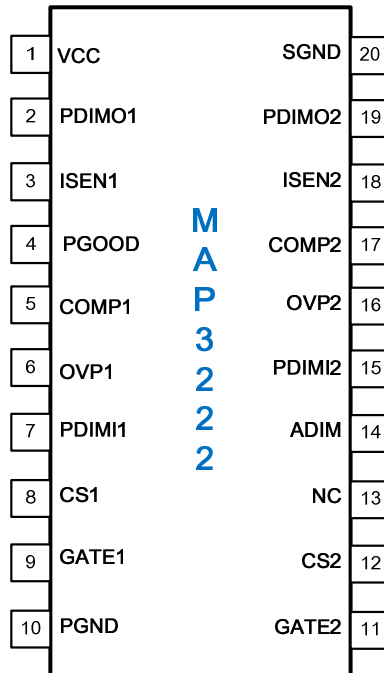

Pin Description

PIN NO	Description
1	VCC Power Supply Input
2	PDIMO1 Ch#1 Dimming PWM Gate Driver Output
3	ISEN1 Ch#1 LED Current Sense connected to Error Amp. Inverting Input
4	PGOOD Power Good
5	COMP1 Ch#1 Error Amp. Compensation
6	OVP1 Ch#1 Over voltage protection
7	PDIMI1 Ch#1 Dimming PWM Gate Driver Input
8	CS1 Ch#1 Current sense of the Boost Convert
9	GATE1 Ch#1 Gate drive Output for Boost Convert
10	PGND Power GND
11	GATE2 Ch#2 Gate drive Output for Boost Convert
12	CS2 Ch#2 Current sense of the Boost Convert
13	NC No Connection
14	ADIM Analog Dimming for Ch#1 and Ch#2
15	PDIMI2 Ch#2 Dimming PWM Gate Driver Input
16	OVP2 Ch#2 Over voltage protection
17	COMP2 Ch#2 Error Amp. Compensation
18	ISEN2 Ch#2 LED Current Sense connected to Error Amp. Inverting Input
19	PDIMO2 Ch#2 Dimming PWM Gate Driver Output
20	SGND Signal GND

Absolute Maximum Ratings

PARAMETER	VALUE	UNIT
VCC	-0.3 ~ 24	V
GATE1/2, PDIMO1/2	-0.3 ~ 24	V
PDIMI1/2, CS1/2, COMP1/2, ISEN1/2, ADIM, OVP1/2	-0.3 ~ 5.5	V
PGOOD	-0.3 ~ 3.5	V
Operating Junction Temperature Range	-40 ~ 125	℃
Storage Temperature Range	-65 ~ 150	℃
Lead temperature(soldering, 10sec)	260	℃
Thermal Resistance (θ_{JA})	90	℃/W

Electrical Characteristics

 $V_{CC}=12V$, $V_{PDIM1}=5V$, $C_{GATE}=C_{PDIM0}=1nF$, $T_a=25^{\circ}C$, unless otherwise specified

SYMBOL	PARAMETER	TEST CONDITION	MIN	TYP	MAX	UNIT
SUPPLY						
$V_{CC,OP}$	Input voltage range	$T_a=-40^{\circ}C \sim 85^{\circ}C$	8.7	-	20	V
I_q	Operation quiescent current	PDIMI 1/2 =0V	-	2	4	mA
I_{OP}	Operation Current	PDIMI 1/2 =5V	-	-	20	mA
V_{UVLO}	Under-voltage lockout release threshold	-	7.7	8.2	8.7	V
	Under-voltage lockout hysteresis	-	-	1	-	V
Oscillator						
F_{OSC}	Oscillator frequency	$T_a= 25^{\circ}C$	190	200	210	kHz
		$T_a= -40^{\circ}C \sim 85^{\circ}C$	180	200	220	kHz
D_{MAX}	Maximum duty cycle	-	-	90	-	%
GATE (CH1, CH2)						
I_{SOURCE}	Gate short circuit current	$V_{GATE}=0$, $V_{CC}=12V$	0.4	-	-	A
I_{SINK}	Gate sink current	$V_{GATE}=12V$, $V_{CC}=12V$	0.8	-	-	A
T_{RISE}	GATE output rise time	$C_{GATE}=1nF$, $V_{CC}=12V$	-	50	85	ns
T_{FALL}	GATE output fall time	$C_{GATE}=1nF$, $V_{CC}=12V$	-	25	45	ns
Current Sense (CH1, CH2)						
T_{BLANK}	Leading Edge Blanking	-	100	-	375	ns
T_{DELAY}	Delay to output of CS comparator(2)	$V_{COMP}=5V$ $V_{CS}=0V$ to 600mV step pulse	-	-	180	ns
$V_{CS,MAX}$	Maximum CS Voltage	$V_{CC}=12V$, $V_{ADIM} - V_{ISEN} > 0.2$	0.35	0.4	0.45	V
Internal Transconductance Opamp (CH1, CH2)						
A_v	Open loop DC Gain(2)	-	-	70	-	dB
V_{CM}	Input common-mode range	-	0.1	-	3.0	V
V_o	Output Voltage Low Limit	$V_{CC}=12V$, $V_{ISEN} - V_{ADIM} > 0.2$	-	0.6	-	V
	Output Voltage High Limit	$V_{CC}=12V$, $V_{ADIM} - V_{ISEN} > 0.2$	-	2.6	-	V
G_m	Transconductance(2)	-	400	670	1000	$\mu A/V$
I_{BIAS}	Input Bias current	-	-	0.5	1	nA

Electrical Characteristics (Continued)

$V_{CC}=12V$, $V_{PDIM1}=5V$, $C_{GATE}=C_{PDIMO}=1nF$, $T_a=25^{\circ}C$, unless otherwise specified

SYMBOL	PARAMETER	TEST CONDITION	MIN	TYP	MAX	UNIT
Internal Transconductance Opamp (CH1, CH2)						
V_{OFFSET}	Input Offset voltage	-	-5	-	5	mV
I_{AMP_SOURCE}	AMP Source Current	$V_{ISEN}=1V$, $V_{ADIM}=2V$, $COMP=1.5V$	-	-100	-	μA
I_{AMP_SINK}	AMP Sink Current	$V_{ISEN}=2V$, $V_{ADIM}=1V$, $COMP=1.5V$	-	100	-	μA
Dimming PWM Input (CH1, CH2)						
$V_{PDIM1(LO)}$	PDIMI input Low voltage	-	-	-	0.8	V
$V_{PDIM1(HI)}$	PDIMI input High voltage	-	2.0	-	-	V
R_{PDIM1}	PDIMI pull-down resistance	$V_{PDIM1}=5V$	50	100	150	$k\Omega$
Dimming PWM Output (CH1, CH2)						
$T_{RISE,PDIMO}$	PDIMO Output rise time	1nF capacitance at PDIMO	-	-	300	ns
$T_{FALL,PDIMO}$	PDIMO Output fall time	1nF capacitance at PDIMO	-	-	200	ns
Auto Restart Protection (OVP & SCP)						
T_{AR}	Auto Restart Time	-	-	1	-	msec
Over Voltage Protection (OVP)						
V_{OVP}	Over voltage protection	-	2.9	3.0	3.1	V
V_{OVPH}	Over voltage protection hysteresis		-	0.3	-	V
T_{OVP}	OVP Filtering time(2)		-	200	-	ns
Short current protection (SCP)						
$V_{TH,SCP}$	SCP Comparator threshold voltage	$V_{ADIM} = 1V (V_{TH,SCP} = V_{ADIM} * 4)$	3.6	4	4.4	V
V_{SCP}	SCP Comparator input range	-	1.4	-	5.0	V
T_{OFF}	Propagation time for short current detection (2)	$V_{ADIM}=1V$, $V_{ISEN}=3$ to $5V$ step V_{PDIMO} goes from high to low	-	-	250	ns
PGOOD Impedance						
R_{UP}	Pull-up Resistance	PGOOD = 3.3V	-	9	-	$k\Omega$
R_{DOWN}	Pull-Down Resistance		-	1.5	-	$k\Omega$

Note 1: Stress beyond the maximum ratings listed above may incur permanent damage to the device. Operating above the recommended conditions for extended time may stress the device and affect device reliability. Also the device may not operate normally above the recommended operating conditions. These are stress ratings only.

Note 2: These parameters, although guaranteed by design, are not tested in mass production.

Typical Operating Characteristics

Unless otherwise noted, $V_{CC} = 12V$, $V_{PDIM1} = 5V$, and $T_a = 25^\circ C$.

Quiescent Current vs. Vcc

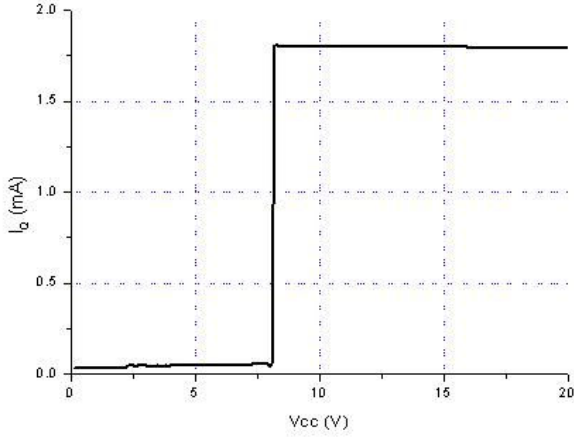

Quiescent Current vs. Temp

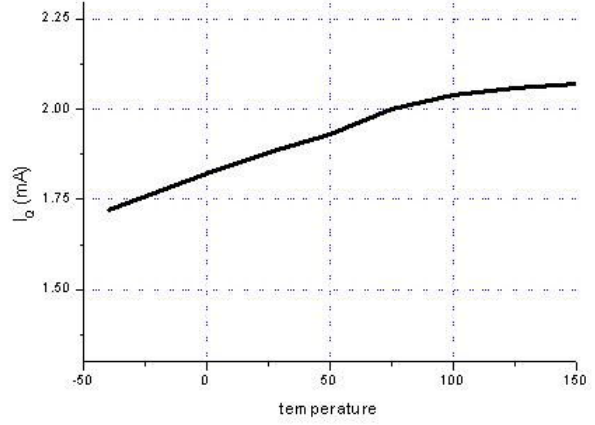

Operation Current vs. Vcc

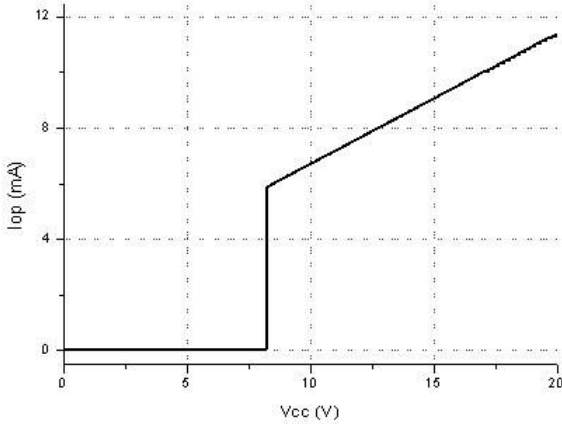

Operation Current vs. Temp

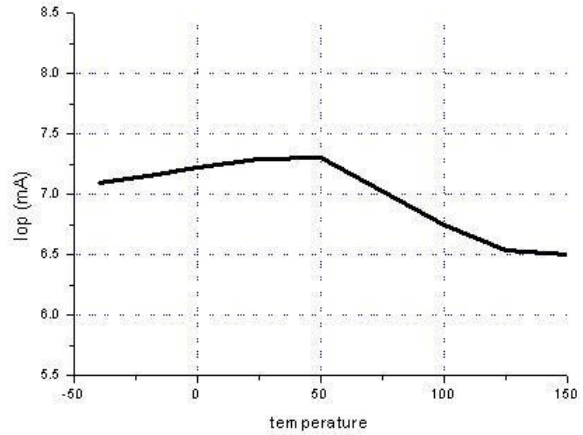

Frequency vs. Temp

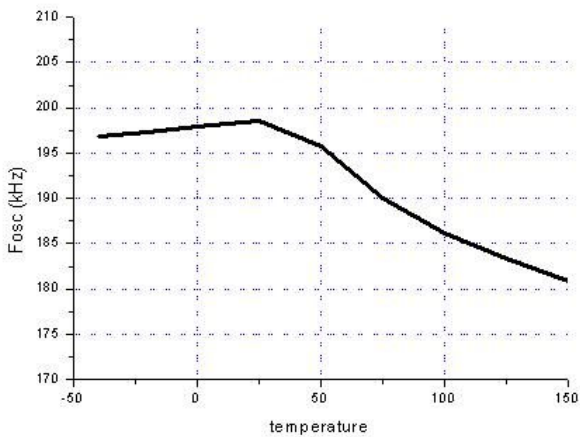

Under Voltage Lock Out (UVLO)

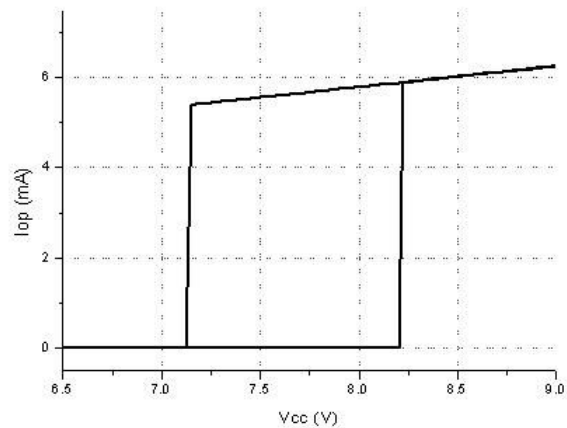

Typical Operating Characteristics

Unless otherwise noted, $V_{CC} = 12V$, $V_{PDIM1} = 5V$, and $T_a = 25^\circ C$.

Over Voltage Protection.(OVP)

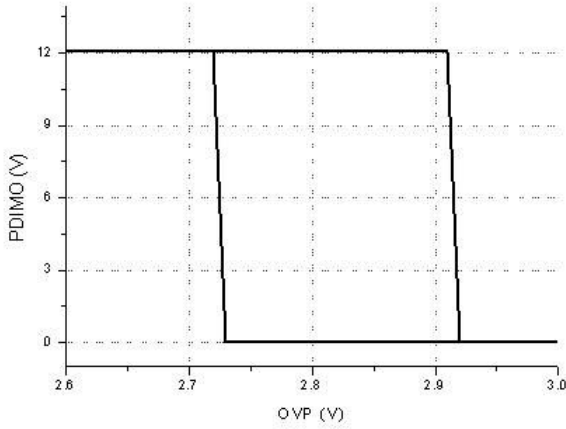

Power Good @ ADIM = 1V

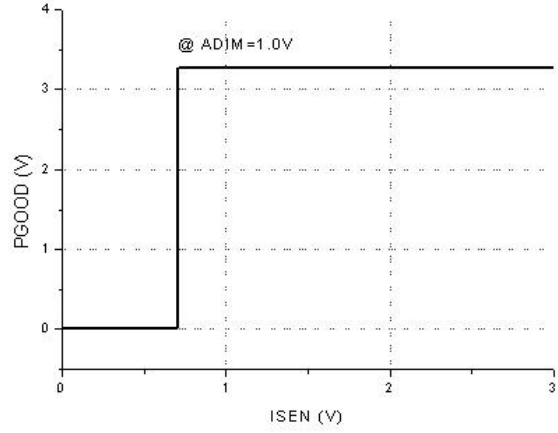

Power Good @ ADIM = 2V

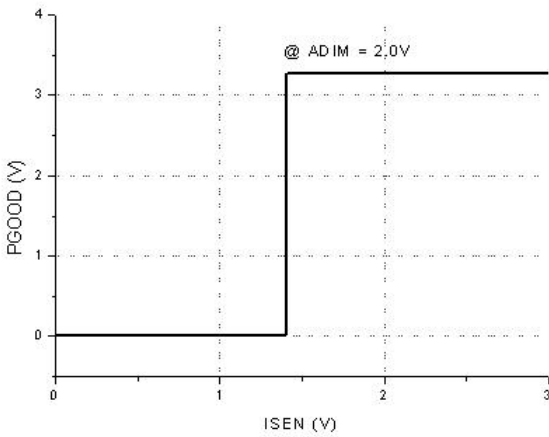

Power Good @ ADIM = 3V

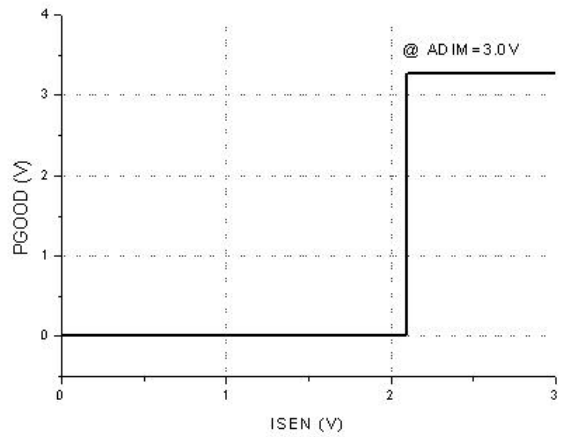

Short Current Protection. (SCP) @ ADIM = 0.1V

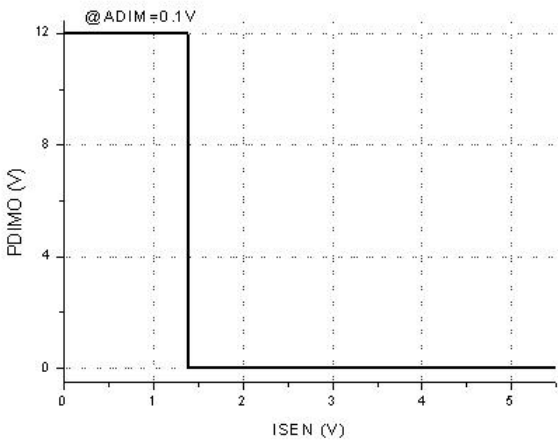

Short Current Protection. (SCP) @ ADIM = 1.0V

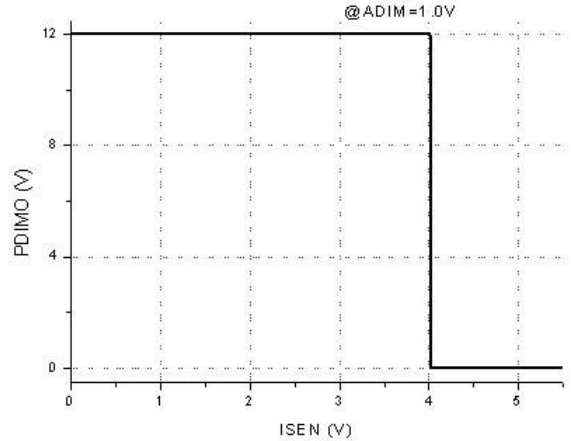

Application Information

MAP3222 has an independent dual channel Boost type LED driver. So, it can be controlled independently.

Current Mode Boost switching regulator operation

MAP3222 is being used Current mode control scheme for boost regulation so its response is fast and output voltage is stable.

MAP3222 is designed to be operated in DCM so MAP3222 can be unstable when it operates in CCM and duty cycle is 50% or higher.

Supply voltage and Oscillator

MAP3222 has wide input voltage ranged from 8.5V to 20V. 1uF decoupling capacitor is used to stabilize the internal regulator and minimize noise on VCC pin. This decoupling capacitor should be placed next to VCC pin. Ceramic capacitor is recommended and incorrect placement of this decoupling capacitor may cause the oscillation in the switching waveform

MAP3222 is being operated at fixed 200KHz and max duty is 90%.

LED Current Input setting (ADIM Input)

MAP3222's LED current is set by the voltage on ADIM pin and LED sense resistor value as below.

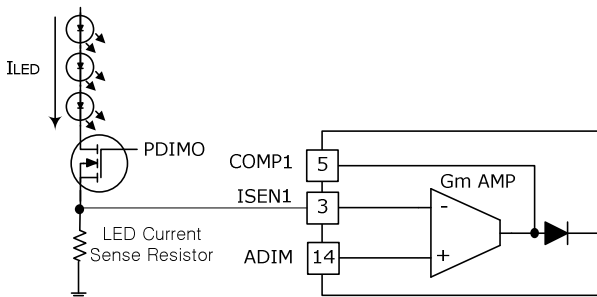

Fig 1. Schematic for LED current set

$$I_{LED} = \frac{V_{ADIM}}{LED_Current_Sense_R}$$

The voltage range on ADIM pin is 0.1V ~ 3.0V. But it is recommended that ADIM Input voltage is higher than 0.4V.

Dimming PWM Input

MAP3222's PDIMI signal is used for both Enable and PWM dimming input. MAP3222 is enabled when PDIMI voltage is higher than 2.0V and disabled when PDIMI voltage is lower than 0.8V. This pin has internal 100Kohm pull down resistance

PWM Input	Condition
High	Enable
Low	Disable

Protection

MAP3222 has Under Voltage Lock Out (UVLO), Boost switch current limit, Output Over Voltage Protection (OVP), LED Short Current Protection(SCP).

When OVP and LED SCP are happened, MAP3222 monitors if the failure condition is released or not every 1ms. This is MAP3222's Auto restart function.

1. Under Voltage Lock Out (UVLO)

When VCC is higher than 8.2V, MAP3222's internal 5V regulator and internal circuitry like oscillator, protections, Gate drivers and PDIMO drivers are enabled, and the MAP3222 starts to operate when PDIMI voltage is higher than 2.0V.

If VCC is lower than 7.2V, MAP3222 is disable due to its Under voltage lock out.

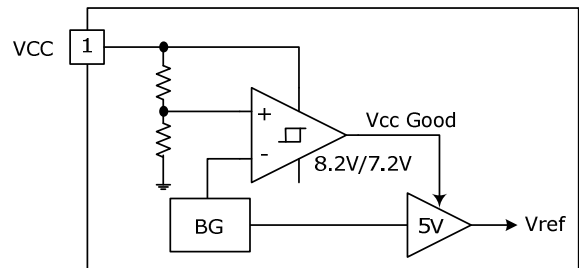

Fig 2. Schematic for Under voltage Lock out

2. Boost current limit and Current Sense (CS)

MAP3222 has the Boost current limit function. If the voltage on CS pin is higher than 0.4V (Typ.), the gate pulse is limited every pulse. MAP3222 has 100nS (Min.) leading edge blank.

3. Output Over Voltage Protection (OVP)

When MAP3222's output voltage is increased abnormally, MAP3222 stops the switching to protect external components.

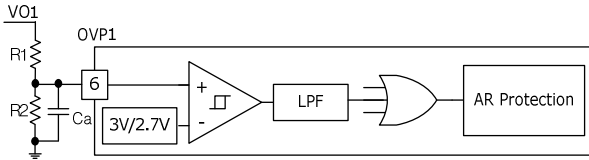

Fig 3. Schematic for Over voltage protection

MAP3222 has 200nS (Typ.) low pass filter on OVP pin, but using external Capacitor (Ca) is recommended to minimize noise. The total values of R1 and R2 need to be lower than 1Mohm.

OVP threshold voltage is 3.0V and OVP voltage can be set as below.

- OVP set voltage :

$$V_{O1} = 3.0 \times \frac{R1 + R2}{R2}$$

- OVP release voltage :

$$V_{O1} = 2.7 \times \frac{R1 + R2}{R2}$$

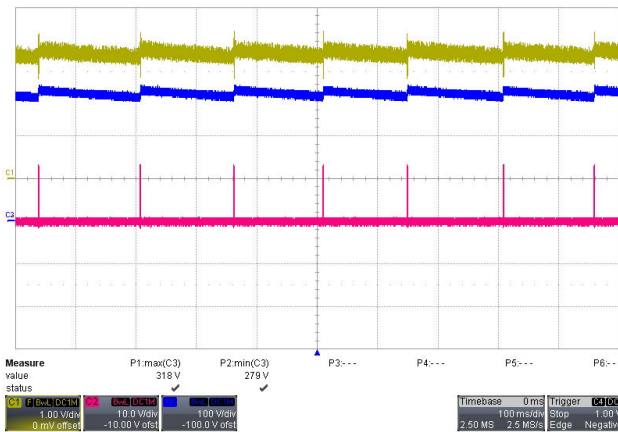

Ch1: OVP, Ch2: Gate, Ch3: Vout

Fig 4. OVP Waveform

4. LED Short Current Protection (SCP)

To protect external components, MAP3222 has the LED short protection. If the LED SCP threshold voltage changes based on ADIM voltage as below, so if ISEN voltage is higher than LED SCP threshold voltage, MAP3222 will be in LED SCP mode disabling gate for boost MOSFET and dimming MOSFET.

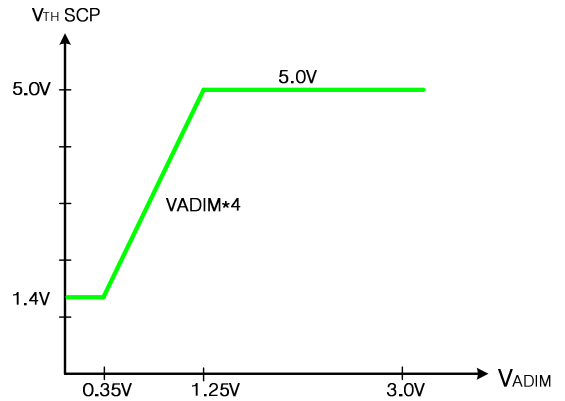
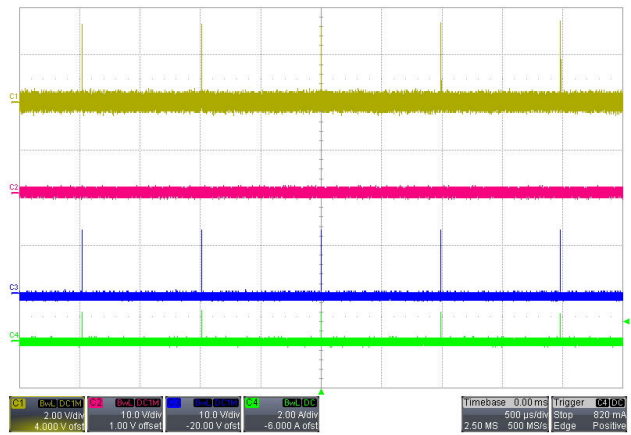

Fig 5. SCP threshold voltage based on ADIM voltage



Ch1: ISEN, Ch2: GATE, Ch3: PWM0, Ch4: I_LED

Fig 6. LED SCP waveform

5. Auto-Restart Protection

The MAP3222 offers Auto Restart protection function which is recovered into normal operation mode when protection condition is cleared. The auto restart time (TAR) is fixed at 1mS,

It is recovered to normal operating mode if SCP or OVP condition is cleared.

6. Power Good (PGOOD)

MAP3222 has the PGOOD pin to send out the LED current status. PGOOD will be high when the LED current is higher than 70% of normal LED current and will be low when the LED current is below 70%.

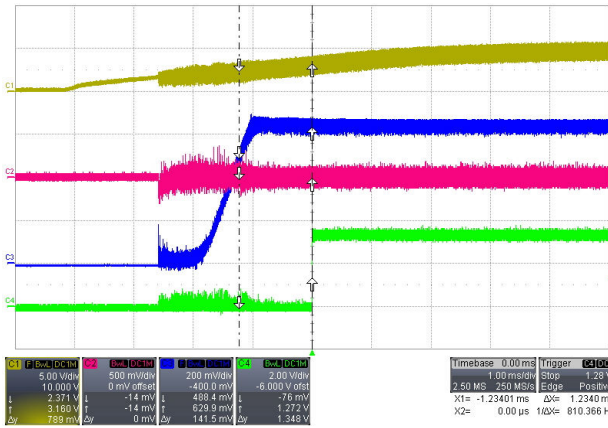

Ch1: PDIMI, Ch2: ADIM, Ch3: ISEN, Ch4: PGOOD

Fig 7. Start-up PGOOD waveform

1) Power Good scheme at OVP Protection.

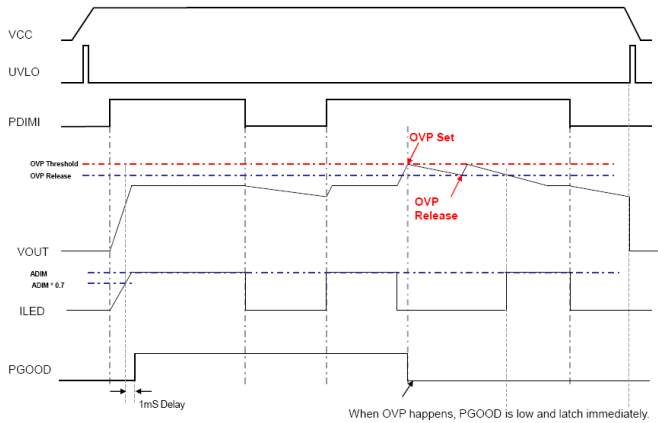

When OVP happens, PGOOD is low and latch immediately.

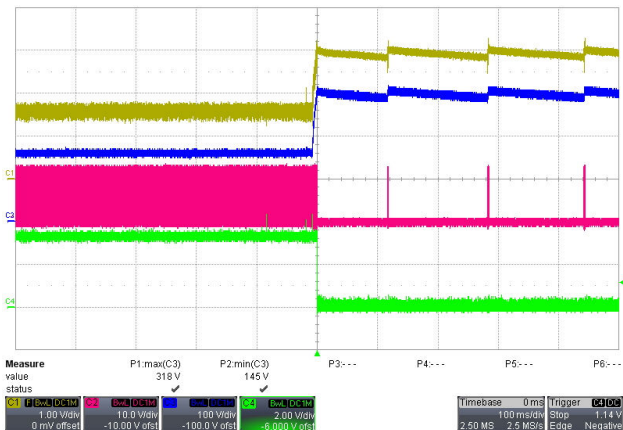

Ch1: OVP, Ch2: GATE, Ch3: VOUT, Ch4: PGOOD

Fig 8. PGOOD waveform @ OVP Protection

When OVP happens, PGOOD is low and latch immediately.
PGOOD reset should be only shut down of IC Vcc.

2) Power Good scheme at SCP Protection.

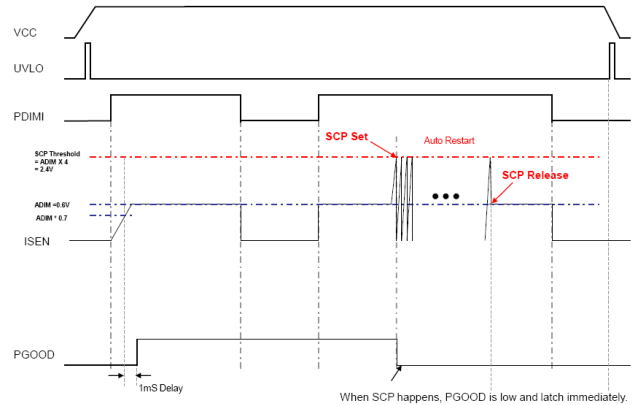

When SCP happens, PGOOD is low and latch immediately.

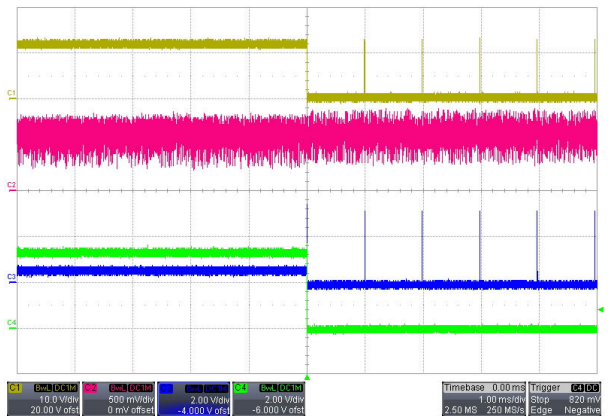

Ch1: PDIMO, Ch2: ADIM, Ch3: ISEN, Ch4: PGOOD

Fig 9. PGOOD waveform @ SCP Protection

When SCP happens, PGOOD is low and latch immediately.
PGOOD reset should be only shut down of IC Vcc.

Evaluation Board Schematic

Condition : Vin=120V, Vout = 63LEDs, LED current = 130mA, OVP set = 303V, Release = 272V, SW Frequency=200KHz

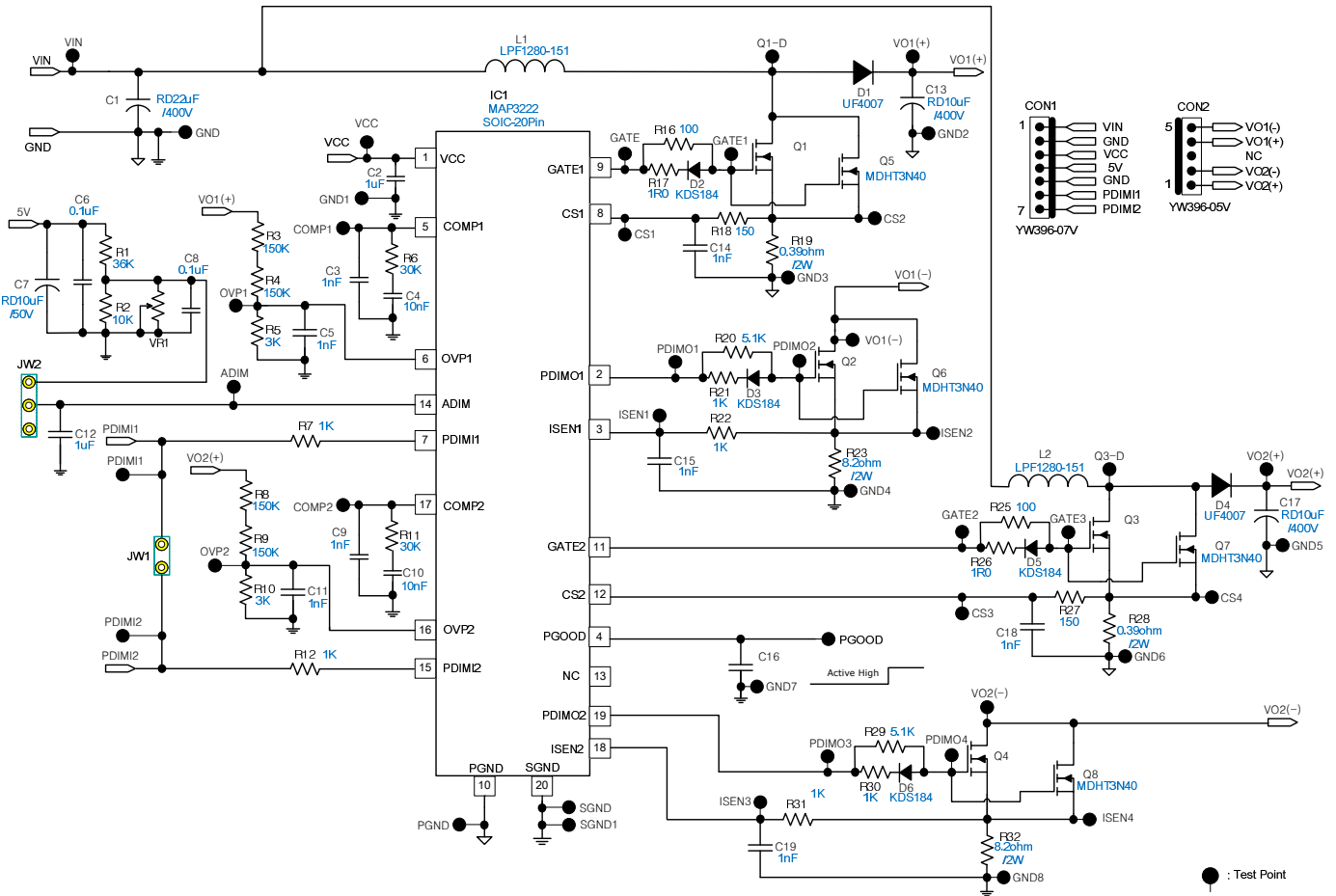

Evaluation Board Part List

	Spec	Vendor	P/N
Input Capacitor	10µF/400V	SAMWHA ¹	RD22µF/400V
Output Capacitor	10µF/400V	SAMWHA ¹	RD10µF/400V
Inductor	150µH	ABCO ²	LPF1280-151
Boost MOSFET	3A/400V, N-Ch, SOT223	MagnaChip	MDHT3N40
Dimming MOSFET	3A/400V, N-Ch, SOT223	MagnaChip	MDHT3N40
Ultrafast Diode	1A/1000V	VISHAY	UF4007
IC	PWM Controller	MagnaChip	MAP3222

- SAMWHA :
 - ELECTROLYTIC CAPACITOR, SAMWHA ELECTRIC tel : +82-43-261-0200, <http://www.samwha.co.kr/electric>
 - MLCC CAPACITOR, SAMWHA CAPACITOR tel : +82-31-330-5872, <http://www.samwha.co.kr/capacitor>
- ABCO tel : +82-31-730-5000, <http://www.abco.co.kr>

Physical Dimensions

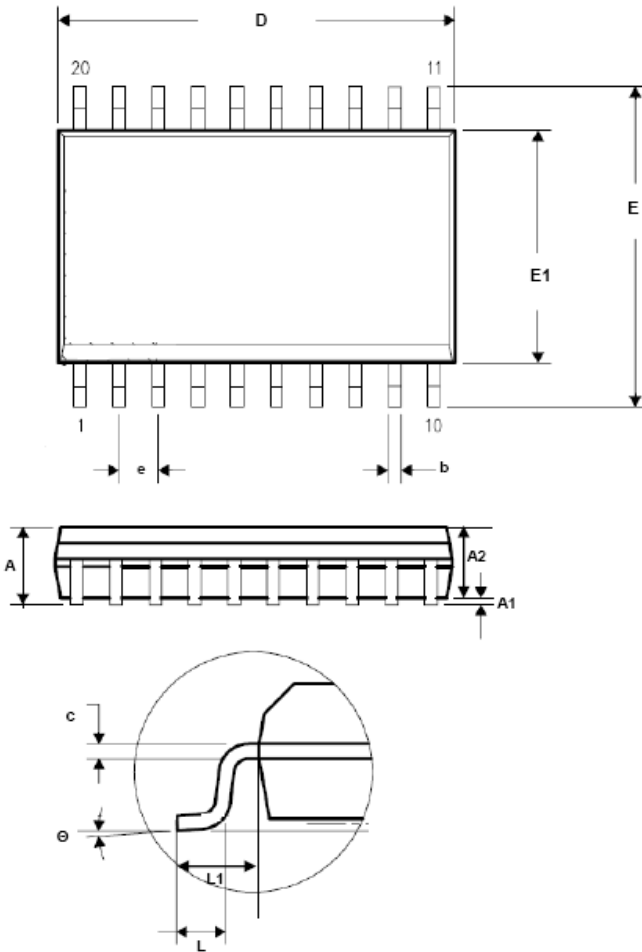

No	REVISION ITEM	DATE	NAME

Symbol	Dimension [mm]		
	Min	Nom	Max
A	-	-	2.65
A1	0.05	-	0.30
A2	2.05	-	2.40
b	0.31	-	0.51
c	0.20	-	0.33
D	12.54	-	13.00
E	10.00	-	10.65
E1	7.30	-	7.70
e	1.27 BSC		
L	0.40	-	1.27
L1	1.40 REF		
θ	0°	-	8°

DIV'D	NAME	DATE	TITLE	20SOIC PACKAGE DRAWING		
DES.BY	Lewis. Park	2010. 07.27	DWG.NO	MBKD-D0832		
APR.BY	SD. Lee	2010. 07.27	REV.NO	0	SHEET	1/1
SCALE	NA	UNIT	mm	MagnaChip		

MagnaChip Semiconductor Ltd. doesn't not recommend the use of its products in hostile environments, including, without limitation, aircraft, nuclear power generation, medical appliances, and devices or systems in which malfunction of any product can reasonably be expected to result in a personal injury. Seller's customers using or selling Seller's products for use in such applications do so at their own risk and agree to fully defend and indemnify Seller.

MagnaChip reserves the right to change the specifications and circuitry without notice at any time. **MagnaChip** does not consider responsibility for use of any circuitry other than circuitry entirely included in a **MagnaChip** product.

MagnaChip is a registered trademark of MagnaChip Semiconductor Ltd.

MagnaChip Semiconductor Ltd.

891, Daechi-Dong, Kangnam-Gu, Seoul, 135-738 Korea

Tel : 82-2-6903-3451 / Fax : 82-2-6903-3668 ~9

www.magnachip.com

Revision History

Date	Version	Changes
2011-03-18	Version 1.0	Initial release